



BAWER

Evolution



PLASTIC
TOOLBOX



PLASTIC
FIRE EXTINGUISHER BOX



POWDER-COATED
TOOLBOX



MATT 3/5 - ALUMINIUM
TOOLBOX



MATT STAINLESS STEEL
TOOLBOX



POLISHED STAINLESS STEEL
TOOLBOX



PATENT PENDING · LPD HOMOLOGATION · FAST MOUNTING SYSTEM



THE TOOLBOX RE^eVOLUTION

FAST MOUNTING
WEIGHT REDUCTION
NEW DESIGN AND MATERIALS

Plastic Toolbox



- pag. **06 - 07** Introduction
- pag. **12 - 13** Toolbox Line
- pag. **26 - 27** Technical Features and Shipment
- pag. **// - 29** Brackets Technical Features
- pag. **30 - 33** Fast Mounting Features and Shipment
- pag. **// - 55** Accessories and Customisations

Fire Extinguisher Plastic Box



- pag. **06 - 07** Introduction
- pag. **14 - 15** Fire Extinguisher Box Line
- pag. **// - 35** Technical Features and Shipment
- pag. **// - 37** Brackets, Ring Holder and
Fast Mounting Kit Technical Features
- pag. **// - 54** Accessories and Customisations

Black, Powder Coated Toolbox



- pag. **08 - 11** Introduction
- pag. **16 - 17** Toolbox Line
- pag. **40 - 41** Technical Features and Shipment
- pag. **// - 49** Brackets Technical Features
- pag. **50 - 53** Fast Mounting Features and Shipment
- pag. **56 - 57** Accessories and Customisations

Matt S/S and Aluminium Toolbox



- pag. **08 - 11** Introduction
- pag. **18 - 19** Toolbox Line
- pag. **42 - 43** Technical Features and Shipment
- pag. **// - 49** Brackets Technical Features
- pag. **50 - 53** Fast Mounting Features and Shipment
- pag. **56 - 57** Accessories and Customisations

Matt S/S Toolbox



- pag. **08 - 11** Introduction
- pag. **20 - 21** Toolbox Line
- pag. **44 - 45** Technical Features and Shipment
- pag. **// - 49** Brackets Technical Features
- pag. **50 - 53** Fast Mounting Features and Shipment
- pag. **56 - 57** Accessories and Customisations

Polished S/S Toolbox



- pag. **08 - 11** Introduction
- pag. **22 - 23** Toolbox Line
- pag. **46 - 47** Technical Features and Shipment
- pag. **// - 49** Brackets Technical Features
- pag. **50 - 53** Fast Mounting Features and Shipment
- pag. **56 - 57** Accessories and Customisations

BAWER

Evolution

PLASTIC Line



LPD HOMOLOGATION



(E8) 73R - 0110378

PATENT PENDING SYSTEM

STACKABILITY

-37/40% VOLUME SAVING

FAST MOUNTING SYSTEM

ASSEMBLY COST REDUCTION

INTEGRATED HANDLE

ACCESSORIES CONFIGURATIONS





BAWER Evolution

METAL Line



LPD HOMOLOGATION



E8 73R - 0110379

PATENT PENDING SYSTEM

WEIGHT REDUCTION

FAST MOUNTING SYSTEM

ASSEMBLY COST REDUCTION

INTEGRATED HANDLE

EMBOSSSED LID

NON-WELDED LID CORNERS

INNOVATIVE WELDING





YouTube
SCAN
to watch



LID CONFIGURATIONS



BLACK, POWDER COATED



MATT S/S AND ALUMINIUM



BAWER evolution
Metal Tolbox

LID CONFIGURATIONS



MATT STAINLESS STEEL



POLISHED STAINLESS STEEL





Easy

Accessories Included

SEAL

Additional Accessories

STOP LID CHAIN

STACKABLE SHIPMENT



cod. E0 140 00 L 500 x H 365 x D 300

cod. E0 150 00 L 500 x H 365 x D 400

cod. E0 200 00 L 600 x H 425 x D 460



cod. E0 250 00 L 800 x H 500 x D 460

cod. E0 300 00 L 1000 x H 500 x D 460

Basic

Accessories Included

SEAL

Additional Accessories

STOP LID CHAIN

SHIPMENT WITH CARDBOARD



cod. E0 140 L 500 x H 365 x D 300

cod. E0 150 L 500 x H 365 x D 400

cod. E0 200 L 600 x H 425 x D 460



cod. E0 250 L 800 x H 500 x D 460

cod. E0 300 L 1000 x H 500 x D 460

Plus

Accessories Included

SEAL

PULL-OUT DRAWER

Additional Accessories

STOP LID CHAIN

SHIPMENT WITH CARDBOARD



cod. E0 151 L 500 x H 365 x D 400

cod. E0 201 L 600 x H 425 x D 460



cod. E0 251 L 800 x H 500 x D 460

cod. E0 301 L 1000 x H 500 x D 460



Brackets

for: Easy, Basic & Plus

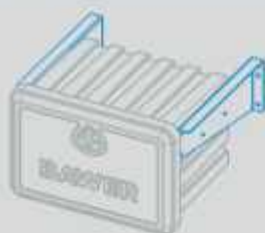

Black Powder Coated Steel Brackets

cod. E0 990 02 Short Horizontal Brackets



Black Powder Coated Steel Brackets

cod. E0 990 04 Long Horizontal Brackets

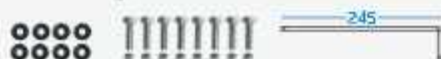

Galvanized Steel Brackets

cod. E0 990 05 Vertical Brackets

Premium

Accessories Included

- SEAL
 - PULL-OUT DRAWER
 - STOP LID CHAIN
 - SYSTEM PREDISPOSED FOR FAST MOUNTING*
- *FAST MOUNTING TUBE NOT INCLUDED

Additional Accessories

- SHIPMENT WITH CARDBOARD



cod. E0 142* L 500 x H 365 x D 300

*PULL-OUT DRAWER NOT AVAILABLE

cod. E0 152 L 500 x H 365 x D 400

cod. E0 202 L 600 x H 425 x D 460



cod. E0 252 L 800 x H 500 x D 460

cod. E0 302 L 1000 x H 500 x D 460

Fast Mounting

for: Premium

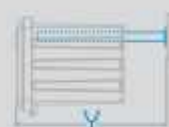
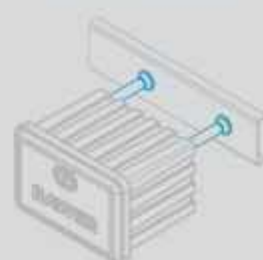

- SHIPMENT WITH CARDBOARD



for toolbox: E0 142

cod. E0 950 02 Short Tube Y: 424 mm.

cod. E0 950 04 Medium Tube Y: 534 mm.

cod. E0 950 06 Long Tube Y: 644 mm.

for toolbox: E0 152

cod. E0 950 12 Short Tube Y: 424 mm.

cod. E0 950 14 Medium Tube Y: 534 mm.

cod. E0 950 16 Long Tube Y: 644 mm.

for toolboxes: E0 202 - E0 252 - E0 302

cod. E0 960 02 Short Tube Y: 582 mm.

cod. E0 960 04 Medium Tube Y: 702 mm.

cod. E0 960 06 Long Tube Y: 822 mm.



Easy

Accessories Included

- LID WITH INSPECTION WINDOW
- EXTINGUISHER RING-HOLDER WITH RUBBER CLAMP

-
- STACKABLE SHIPMENT



cod. **EB 80 2 00** L 280 x H 620 x D 215

Basic

Accessories Included

- LID WITH INSPECTION WINDOW
- EXTINGUISHER RING-HOLDER WITH RUBBER CLAMP

-
- SHIPMENT WITH CARDBOARD



cod. **EB 80 2** L 280 x H 620 x D 215



Easy Plus

Accessories Included

- LID WITH INSPECTION WINDOW
- SYSTEM PREDISPOSED FOR FAST MOUNTING
- FAST MOUNTING KIT:
 - EXTINGUISHER FAST MOUNTING RING-HOLDER WITH RUBBER CLAMP
 - FAST MOUNTING BRACHETS

-
- STACKABLE SHIPMENT



cod. **EB 80 4 00** L 280 x H 620 x D 215

Premium

Accessories Included

- LID WITH INSPECTION WINDOW
- SYSTEM PREDISPOSED FOR FAST MOUNTING
- FAST MOUNTING KIT:
 - EXTINGUISHER FAST MOUNTING RING-HOLDER WITH RUBBER CLAMP
 - FAST MOUNTING BRACHETS

-
- SHIPMENT WITH CARDBOARD



cod. **EB 80 4** L 280 x H 620 x D 215

Basic

Accessories Included

Additional Accessories

- GAS SPRINGS
- AERATOR
- INTERNAL MAT

- SHIPMENT WITH CARDBOARD



cod. E2 150 L 500 x H 350 x D 400

cod. E2 200 L 600 x H 400 x D 500



cod. E2 250* L 800 x H 500 x D 500

*MOUNT ONLY LONG HORIZONTAL BRACKETS EB 990 04

cod. E2 300* L 1000 x H 500 x D 500

Plus

Accessories Included

- PULL-OUT DRAWER

Additional Accessories

- GAS SPRINGS
- AERATOR
- INTERNAL MAT

- SHIPMENT WITH CARDBOARD



cod. E2 151 L 500 x H 350 x D 400

cod. E2 201 L 600 x H 400 x D 500



cod. E2 251* L 800 x H 500 x D 500

*MOUNT ONLY LONG HORIZONTAL BRACKETS EB 990 04

cod. E2 301* L 1000 x H 500 x D 500

Brackets

for: Basic & Plus



Black Powder Coated Steel Brackets

cod. EB 990 02 Short Horizontal Brackets



Black Powder Coated Steel Brackets

cod. EB 990 04 Long Horizontal Brackets



Galvanized Steel Brackets

cod. EB 990 05 Vertical Brackets

Smart

Accessories Included

- PULL-OUT DRAWER
- SYSTEM PREDISPOSED FOR FAST MOUNTING*
- *FAST MOUNTING TUBE NOT INCLUDED

Additional Accessories

- GAS SPRINGS
 - AERATOR
 - INTERNAL MAT
-
- SHIPMENT WITH CARDBOARD



cod. E2 152 L 500 x H 350 x D 400

cod. E2 202 L 600 x H 400 x D 500



cod. E2 252 L 800 x H 500 x D 500

cod. E2 302 L 1000 x H 500 x D 500

Premium

Accessories Included

- PULL-OUT DRAWER
- GAS SPRINGS
- SYSTEM PREDISPOSED FOR FAST MOUNTING*
- *FAST MOUNTING TUBE NOT INCLUDED

Additional Accessories

- AERATOR
 - INTERNAL MAT
-
- SHIPMENT WITH CARDBOARD



cod. E2 153 L 500 x H 350 x D 400

cod. E2 203 L 600 x H 400 x D 500



cod. E2 253 L 800 x H 500 x D 500

cod. E2 303 L 1000 x H 500 x D 500

Fast Mounting

for: Smart & Premium



-
- SHIPMENT WITH CARDBOARD



for toolboxes: E2 152 - E2 153

cod. E2 950 02 Short Tube Y: 424 mm.

cod. E2 950 04 Medium Tube Y: 534 mm.

cod. E2 950 06 Long Tube Y: 644 mm.

for toolboxes: E2 202 - E2 203
E2 252 - E2 253 - E2 302 - E2 303

cod. E2 960 02 Short Tube Y: 582 mm.

cod. E2 960 04 Medium Tube Y: 702 mm.

cod. E2 960 06 Long Tube Y: 822 mm.



Basic

Accessories Included

Additional Accessories

- GAS SPRINGS
- AERATOR
- INTERNAL MAT

- SHIPMENT WITH CARDBOARD



cod. E4 150 L 500 x H 350 x D 400

cod. E4 200 L 600 x H 400 x D 500



cod. E4 250* L 800 x H 500 x D 500

*MOUNT ONLY LONG HORIZONTAL BRACKETS E8 998 04

cod. E4 300* L 1000 x H 500 x D 500

Plus

Accessories Included

- PULL-OUT DRAWER

Additional Accessories

- GAS SPRINGS
- AERATOR
- INTERNAL MAT

- SHIPMENT WITH CARDBOARD



cod. E4 151 L 500 x H 350 x D 400

cod. E4 201 L 600 x H 400 x D 500



cod. E4 251* L 800 x H 500 x D 500

*MOUNT ONLY LONG HORIZONTAL BRACKETS E8 998 04

cod. E4 301* L 1000 x H 500 x D 500

Brackets

for: Basic & Plus



Black Powder Coated Steel Brackets

cod. E8 998 02 Short Horizontal Brackets

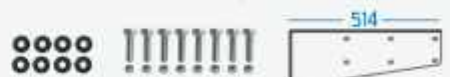

Black Powder Coated Steel Brackets

cod. E8 998 04 Long Horizontal Brackets



Galvanized Steel Brackets

cod. E8 998 05 Vertical Brackets



Smart

Accessories Included

- PULL-OUT DRAWER
- SYSTEM PREDISPOSED FOR FAST MOUNTING*
- *FAST MOUNTING TUBE NOT INCLUDED

Additional Accessories

- GAS SPRINGS
 - AERATOR
 - INTERNAL MAT
-
- SHIPMENT WITH CARDBOARD



cod. E4 152 L 500 x H 350 x D 400

cod. E4 202 L 600 x H 400 x D 500



cod. E4 252 L 800 x H 500 x D 500

cod. E4 302 L 1000 x H 500 x D 500

Premium

Accessories Included

- PULL-OUT DRAWER
- GAS SPRINGS
- SYSTEM PREDISPOSED FOR FAST MOUNTING*
- *FAST MOUNTING TUBE NOT INCLUDED

Additional Accessories

- AERATOR
 - INTERNAL MAT
-
- SHIPMENT WITH CARDBOARD



cod. E4 153 L 500 x H 350 x D 400

cod. E4 203 L 600 x H 400 x D 500



cod. E4 253 L 800 x H 500 x D 500

cod. E4 303 L 1000 x H 500 x D 500

Fast Mounting

for: Smart & Premium

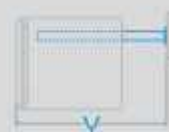
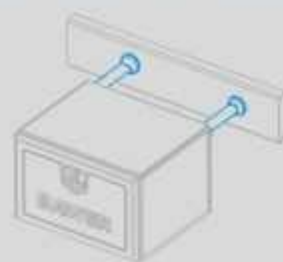

- SHIPMENT WITH CARDBOARD



for toolboxes: E4 152 - E4 153

cod. E2 950 02 Short Tube Y: 424 mm.

cod. E2 950 04 Medium Tube Y: 534 mm.

cod. E2 950 06 Long Tube Y: 644 mm.

for toolboxes: E4 202 - E4 203
E4 252 - E4 253 - E4 302 - E4 303

cod. E2 960 02 Short Tube Y: 582 mm.

cod. E2 960 04 Medium Tube Y: 702 mm.

cod. E2 960 06 Long Tube Y: 822 mm.

Basic

Accessories Included

Additional Accessories

- GAS SPRINGS
- AERATOR
- INTERNAL MAT

- SHIPMENT WITH CARDBOARD



cod. E6 150 L 500 x H 350 x D 400

cod. E6 200 L 600 x H 400 x D 500



cod. E6 250* L 800 x H 500 x D 500

*MOUNT ONLY: LONG HORIZONTAL BRACKETS E0 990 04
LONG HORIZONTAL BRACKETS E6 990 04

cod. E6 300* L 1000 x H 500 x D 500

Plus

Accessories Included

- PULL-OUT DRAWER

Additional Accessories

- GAS SPRINGS
- AERATOR
- INTERNAL MAT

- SHIPMENT WITH CARDBOARD



cod. E6 151 L 500 x H 350 x D 400

cod. E6 201 L 600 x H 400 x D 500



cod. E6 251* L 800 x H 500 x D 500

*MOUNT ONLY: LONG HORIZONTAL BRACKETS E0 990 04
LONG HORIZONTAL BRACKETS E6 990 04

cod. E6 301* L 1000 x H 500 x D 500

Brackets

for: Basic & Plus

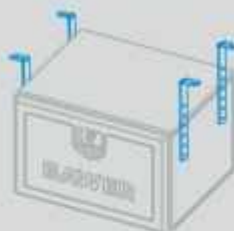

cod. E6 990 02

cod. E6 990 04

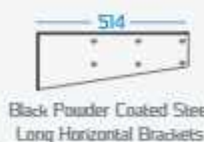

cod. E0 990 02

cod. E0 990 04



cod. E0 990 06

Vertical Brackets

Smart

Accessories Included

- PULL-OUT DRAWER
- SYSTEM PREDISPOSED FOR FAST MOUNTING*
- *FAST MOUNTING TUBE NOT INCLUDED

Additional Accessories

- GAS SPRINGS
- AERATOR
- INTERNAL MAT
-
- SHIPMENT WITH CARDBOARD



cod. E6 152 L 500 x H 350 x D 400

cod. E6 202 L 600 x H 400 x D 500



cod. E6 252 L 800 x H 500 x D 500

cod. E6 302 L 1000 x H 500 x D 500

Premium

Accessories Included

- PULL-OUT DRAWER
- GAS SPRINGS
- SYSTEM PREDISPOSED FOR FAST MOUNTING*
- *FAST MOUNTING TUBE NOT INCLUDED

Additional Accessories

- AERATOR
- INTERNAL MAT
-
- SHIPMENT WITH CARDBOARD



cod. E6 153 L 500 x H 350 x D 400

cod. E6 203 L 600 x H 400 x D 500



cod. E6 253 L 800 x H 500 x D 500

cod. E6 303 L 1000 x H 500 x D 500

Fast Mounting

for: Smart & Premium

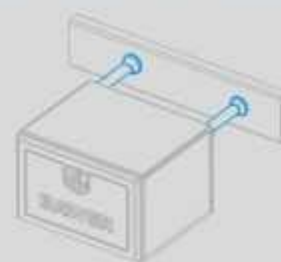

- SHIPMENT WITH CARDBOARD



for toolboxes: E6 152 - E6 153

cod. E2 950 02 Short Tube Y: 424 mm.

cod. E2 950 04 Medium Tube Y: 534 mm.

cod. E2 950 06 Long Tube Y: 644 mm.

for toolboxes: E6 202 - E6 203
E6 252 - E6 253 - E6 302 - E6 303

cod. E2 960 02 Short Tube Y: 582 mm.

cod. E2 960 04 Medium Tube Y: 702 mm.

cod. E2 960 06 Long Tube Y: 822 mm.

Basic

Accessories Included

Additional Accessories

- GAS SPRINGS
- AERATOR
- INTERNAL MAT

- SHIPMENT WITH CARDBOARD



cod. EB 150 L 500 x H 350 x D 400

cod. EB 200 L 600 x H 400 x D 500



cod. EB 250* L 800 x H 500 x D 500

*MOUNT ONLY. LONG HORIZONTAL BRACKETS EB 990 04
LONG HORIZONTAL BRACKETS E5 990 04

cod. EB 300* L 1000 x H 500 x D 500

Plus

Accessories Included

- PULL-OUT DRAWER

Additional Accessories

- GAS SPRINGS
- AERATOR
- INTERNAL MAT

- SHIPMENT WITH CARDBOARD



cod. EB 151 L 500 x H 350 x D 400

cod. EB 201 L 600 x H 400 x D 500



cod. EB 251* L 800 x H 500 x D 500

*MOUNT ONLY. LONG HORIZONTAL BRACKETS EB 990 04
LONG HORIZONTAL BRACKETS E5 990 04

cod. EB 301* L 1000 x H 500 x D 500

Brackets

for: Basic & Plus



422.5
Stainless Steel
Short Horizontal Brackets

cod. E5 990 02

525
Stainless Steel
Long Horizontal Brackets

cod. E5 990 04



423
Black Powder Coated Steel
Short Horizontal Brackets

cod. E0 990 02

514
Black Powder Coated Steel
Long Horizontal Brackets

cod. E0 990 04



Galvanized Steel Brackets

cod. EB 990 06 Vertical Brackets

Smart

Accessories Included

- PULL-OUT DRAWER
 - SYSTEM PREDISPOSED FOR FAST MOUNTING*
- *FAST MOUNTING TUBE NOT INCLUDED

Additional Accessories

- GAS SPRINGS
- AERATOR
- INTERNAL MAT

-
- SHIPMENT WITH CARDBOARD



cod. EB 152 L 500 x H 350 x D 400

cod. EB 202 L 600 x H 400 x D 500



cod. EB 252 L 800 x H 500 x D 500

cod. EB 302 L 1000 x H 500 x D 500

Premium

Accessories Included

- PULL-OUT DRAWER
 - GAS SPRINGS
 - SYSTEM PREDISPOSED FOR FAST MOUNTING*
- *FAST MOUNTING TUBE NOT INCLUDED

Additional Accessories

- AERATOR
- INTERNAL MAT

-
- SHIPMENT WITH CARDBOARD



cod. EB 153 L 500 x H 350 x D 400

cod. EB 203 L 600 x H 400 x D 500



cod. EB 253 L 800 x H 500 x D 500

cod. EB 303 L 1000 x H 500 x D 500

Fast Mounting

for: Smart & Premium

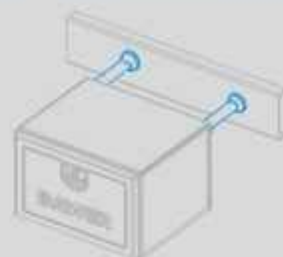

-
- SHIPMENT WITH CARDBOARD



for toolboxes: EB 152 - EB 153

cod. E2 950 02 Short Tube V: 424 mm.

cod. E2 950 04 Medium Tube V: 534 mm.

cod. E2 950 06 Long Tube V: 644 mm.

for toolboxes: EB 202 - EB 203
EB 252 - EB 253 - EB 302 - EB 303

cod. E2 960 02 Short Tube V: 582 mm.

cod. E2 960 04 Medium Tube V: 702 mm.

cod. E2 960 06 Long Tube V: 822 mm.

Plastic Toolbox



BAW

A technical drawing of a mechanical part, possibly a cover or a housing, shown in a perspective view. The drawing is rendered in light gray lines on a white background. The part has a rectangular shape with rounded corners and a recessed area. The word "VER" is visible in a large, bold, sans-serif font, partially cut off on the left side. The drawing shows various lines representing the geometry and features of the part, including a circular feature on the left side and a recessed rectangular area in the center.

VER

Technical Features



Easy_toolboxes

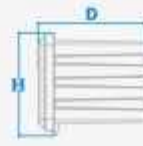
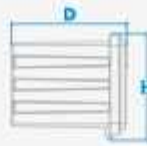

toolbox code	toolbox size mm.			toolbox weight kg	load capacity kg
	L	H	D		
cod. E0 140 00	500	365	300	2,2	40
cod. E0 150 00	500	365	400	2,5	40
cod. E0 200 00	600	425	460	4,8	45

toolbox code	toolbox size mm.			toolbox weight kg	load capacity kg
	L	H	D		
cod. E0 250 00	800	500	460	7,3	50
cod. E0 300 00	1000	500	460	10,5	55

Basic_toolboxes

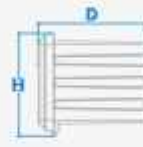
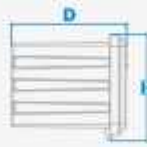

toolbox code	toolbox size mm.			toolbox weight kg	load capacity kg
	L	H	D		
cod. E0 140	500	365	300	2,2	40
cod. E0 150	500	365	400	2,5	40
cod. E0 200	600	425	460	4,8	45

toolbox code	toolbox size mm.			toolbox weight kg	load capacity kg
	L	H	D		
cod. E0 250	800	500	460	7,3	50
cod. E0 300	1000	500	460	10,5	55

Plus_toolboxes

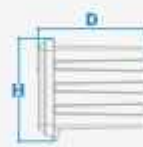
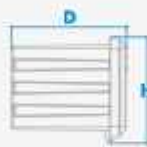

toolbox code	toolbox size mm.			toolbox weight kg	load capacity kg
	L	H	D		
cod. E0 151	500	365	400	3,5	40
cod. E0 201	600	425	460	6,2	45

toolbox code	toolbox size mm.			toolbox weight kg	load capacity kg
	L	H	D		
cod. E0 251	800	500	460	9	50
cod. E0 301	1000	500	460	12,7	55

Premium_toolboxes

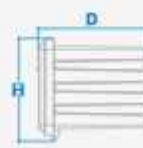
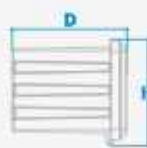

toolbox code	toolbox size mm.			toolbox weight kg	load capacity kg
	L	H	D		
cod. E0 142	500	365	300	2,4	40
cod. E0 152	500	365	400	3,9	40
cod. E0 202	600	425	460	6,7	45

toolbox code	toolbox size mm.			toolbox weight kg	load capacity kg
	L	H	D		
cod. E0 252	800	500	460	9,5	50
cod. E0 302	1000	500	460	13,3	55



Easy_stackable shipment



toolbox code	20 BOX			pieces per pallet	Tot. pallet	40 FT HC			pieces per pallet	Tot. pallet	TRUCK			pieces per pallet	Tot. pallet
	L	H	D			L	H	D			L	H	D		
cod. E0 140 00	1330	2270	1065	56	8	1330	2450	1065	64	18	1330	2450	1065	64	22
cod. E0 150 00	1330	2160	1065	48	8	1330	2520	1065	64	18	1330	2520	1065	64	22
cod. E0 200 00	1330	2222	1065	35	8	1330	2222	1065	35	18	1330	2222	1065	35	22
cod. E0 250 00	1100	2215	840	14	14	1100	2215	840	14	28	1100	2215	840	14	32
cod. E0 300 00	1060	2050	1060	12	10	1060	2295	1060	14	22	1060	2295	1060	14	24

Basic_shipment with cardboard

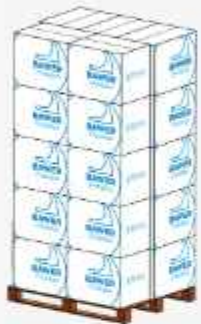

toolbox code	20 BOX			pieces per pallet	Tot. pallet	40 FT HC			pieces per pallet	Tot. pallet	TRUCK			pieces per pallet	Tot. pallet
	L	H	D			L	H	D			L	H	D		
cod. E0 140	1140	2050	1040	36	10	1140	2370	1040	42	22	1140	2690	1040	48	26
cod. E0 150	1140	2230	1040	30	10	1140	2230	1040	30	22	1140	2650	1040	36	26
cod. E0 200	1330	2050	1065	20	8	1330	2530	1065	25	18	1330	2530	1065	25	22
cod. E0 250	1100	2050	840	8	14	1100	2530	840	10	28	1100	2530	840	10	32
cod. E0 300	1060	2050	1060	8	10	1060	2530	1060	10	22	1060	2530	1060	10	24

Plus_shipment with cardboard

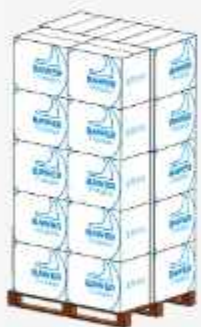

toolbox code	20 BOX			pieces per pallet	Tot. pallet	40 FT HC			pieces per pallet	Tot. pallet	TRUCK			pieces per pallet	Tot. pallet
	L	H	D			L	H	D			L	H	D		
cod. E0 151	1140	2230	1040	30	10	1140	2230	1040	30	22	1140	2650	1040	36	26
cod. E0 201	1330	2050	1065	20	8	1330	2530	1065	25	18	1330	2530	1065	25	22
cod. E0 251	1100	2050	840	8	14	1100	2530	840	10	28	1100	2530	840	10	32
cod. E0 301	1060	2050	1060	8	10	1060	2530	1060	10	22	1060	2530	1060	10	24

Premium_shipment with cardboard

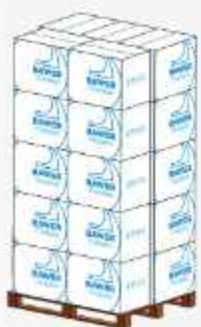

toolbox code	20 BOX			pieces per pallet	Tot. pallet	40 FT HC			pieces per pallet	Tot. pallet	TRUCK			pieces per pallet	Tot. pallet
	L	H	D			L	H	D			L	H	D		
cod. E0 142	1140	2050	1040	36	8+2*	1140	2370	1040	42	16+6*	1140	2690	1040	48	18+8*
cod. E0 152	1140	2230	1040	30	8+2*	1140	2230	1040	30	18+4*	1140	2650	1065	36	20+4*
cod. E0 202	1330	2050	1065	20	6+2*	1330	2530	1065	25	13+5*	1330	2530	1065	25	17+5*
cod. E0 252	1100	2050	840	8	12+2*	1100	2530	840	10	24+4*	1100	2530	840	10	28+4*
cod. E0 302	1060	2050	1060	10	9+1*	1060	2530	1060	10	19+3*	1060	2530	1060	10	21+3*

* Total number of pallets with Fast Mounting kit to satisfy the total number of toolboxes pallets

Brackets & Fast Mounting



PLASTIC Toolbox

Short Horizontal Brackets

cod. E0 990 02 - Black, Powder Coated Brackets



- Hex-head screws M8x25, 8 pcs
- Washer M8, 8 pcs
- Self-blocking nuts M8, 8 pcs

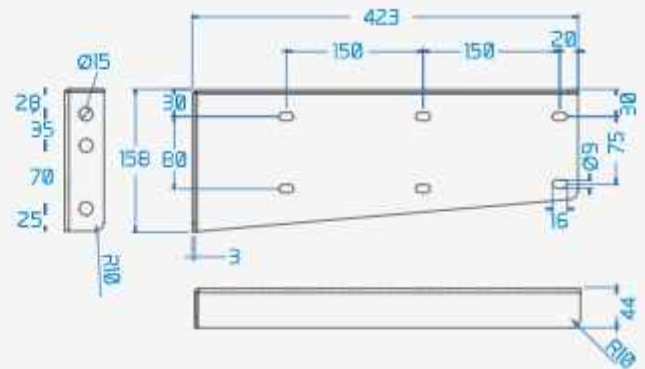

Long Horizontal Brackets

cod. E0 990 04 - Black, Powder Coated Brackets



- Hex-head screws M8x25, 8 pcs
- Washer M8, 8 pcs
- Self-blocking nuts M8, 8 pcs

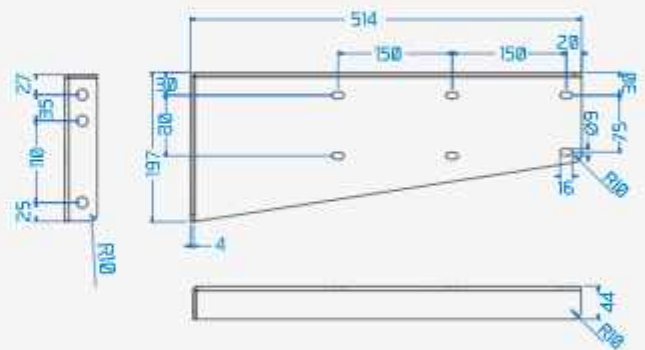

Vertical Brackets

cod. E0 990 06 - Galvanized Steel Brackets

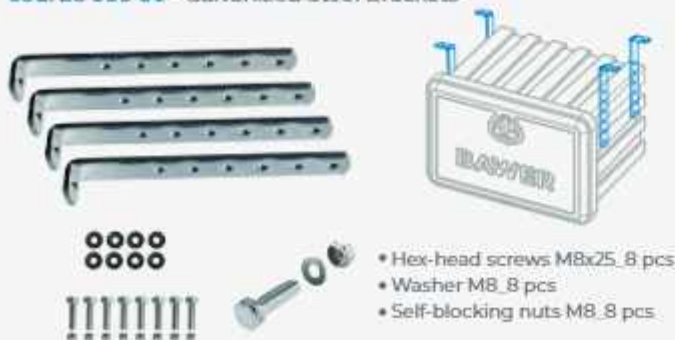

- Hex-head screws M8x25, 8 pcs
- Washer M8, 8 pcs
- Self-blocking nuts M8, 8 pcs

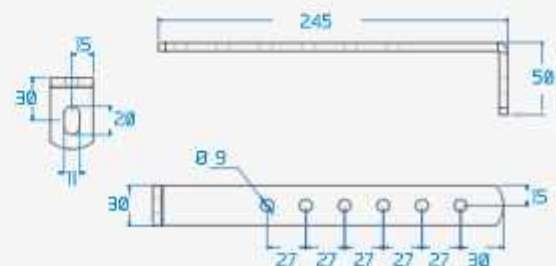



Assembly Steps_Fast Mounting

Step_1 Make two holes in the truck chassis and screw the fast connection tubes without tightening.

Step_2 Insert the toolbox until it stops (CLICK) and tighten the screw.

Step_3 Open the toolbox and insert the safety plugs.

Assembly completed.

Step_1

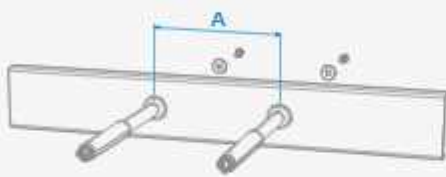

Step_2

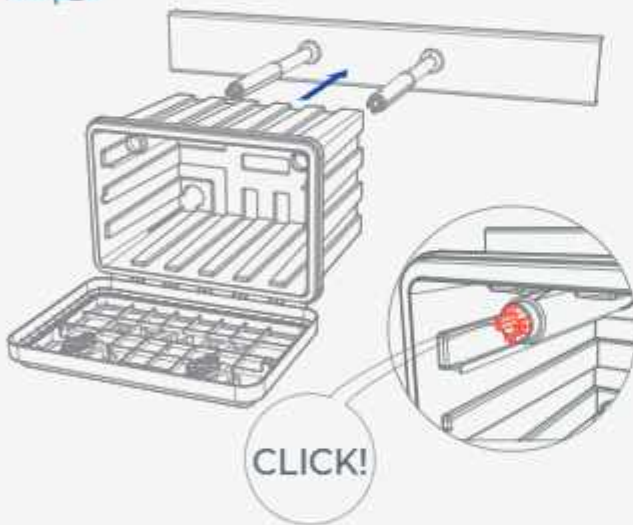

Step_3

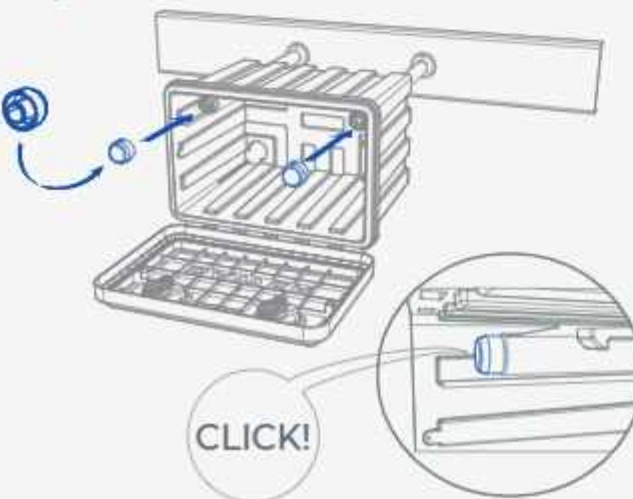

Technical Features_Fast Mounting



Black Powder Coated Steel Tube

TUBE - A



short, medium and long tube

TUBE - B



customized tube with multi holes

FEATURES TUBE - B

Check which distance "Y" you need and cut as show below. After cutting it is recommended to use an anticorrosive paint.

EXAMPLE OF CUTTING TUBE



EXAMPLE OF ASSEMBLED TUBE

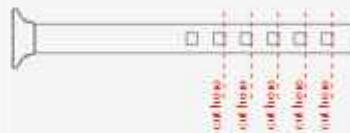

- Hex-head Screw M18
Fine pitch thread
- Washer M18
Wide strip

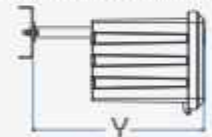

For Toolbox code	Tube diameter	A mm.	Fast Mounting Tube code	Y TUBE - A	Y TUBE - B
cod. E0 142 L 500 x H 365 x D 300	Ø 30	354	E0 950 02 - Short Tube	Y1: 424 mm.	Y1: 604 mm.
			E0 950 04 - Medium Tube	Y1: 534 mm.	Y2: 576 mm.
			E0 950 06 - Long tube	Y1: 644 mm.	Y3: 548 mm.
			E0 950 08 - Customized Tube	Y: TUBE - B	Y4: 520 mm.
cod. E0 152 L 500 x H 365 x D 400	Ø 30	354	E0 950 12 - Short Tube	Y1: 424 mm.	Y5: 492 mm.
			E0 950 14 - Medium Tube	Y1: 534 mm.	Y6: 464 mm.
			E0 950 16 - Long tube	Y1: 644 mm.	Y6: 464 mm.
cod. E0 202 L 600 x H 425 x D 460	Ø 42	430	E0 960 02 - Short Tube	Y1: 582 mm.	Y1: 798 mm.
			E0 960 04 - Medium Tube	Y1: 702 mm.	Y2: 770 mm.
			E0 960 06 - Long tube	Y1: 822 mm.	Y3: 742 mm.
			E0 960 08 - Customized Tube	Y: TUBE - B	Y4: 714 mm.
cod. E0 252 L 800 x H 500 x D 460	Ø 42	621	E0 960 02 - Short Tube	Y1: 582 mm.	Y5: 686 mm.
			E0 960 04 - Medium Tube	Y1: 702 mm.	Y6: 658 mm.
			E0 960 06 - Long tube	Y1: 822 mm.	Y7: 630 mm.
cod. E0 302 L 1000 x H 500 x D 460	Ø 42	811	E0 960 02 - Short Tube	Y1: 582 mm.	Y8: 602 mm.
			E0 960 04 - Medium Tube	Y1: 702 mm.	Y9: 574 mm.
			E0 960 06 - Long tube	Y1: 822 mm.	Y10: 546 mm.
			E0 960 08 - Customized Tube	Y: TUBE - B	



Packaging & Shipment_Fast Mounting



Shipment_Fast Mounting for Toolbox E0 142



Mounting Hit tube code	20 BOX				40 FT HC				TRUCK						
	pallet size mm.			pieces per pallet	Tot. pallet	pallet size mm.			pieces per pallet	Tot. pallet	pallet size mm.			pieces per pallet	Tot. pallet
	L	H	D			L	H	D			L	H	D		
cod. ED 950 02	1140	760	1040	144	2	1140	620	1040	112	6	1140	620	1040	108	8
cod. ED 950 04	1140	760	1040	144	2	1140	620	1040	112	6	1140	620	1040	108	8
cod. ED 950 06/08	1140	970	1040	144	2	1140	830	1040	112	6	1140	760	1040	108	8

Shipment_Fast Mounting for Toolbox E0 152



Mounting Hit tube code	20 BOX				40 FT HC				TRUCK						
	pallet size mm.			pieces per pallet	Tot. pallet	pallet size mm.			pieces per pallet	Tot. pallet	pallet size mm.			pieces per pallet	Tot. pallet
	L	H	D			L	H	D			L	H	D		
cod. ED 950 12	1140	690	1040	120	2	1140	760	1040	135	4	1140	690	1040	120	4
cod. ED 950 14	1140	690	1040	120	2	1140	760	1040	135	4	1140	690	1040	120	4
cod. ED 950 16/18	1140	830	1040	120	2	1140	970	1040	135	4	1140	830	1040	120	4

Shipment_Fast Mounting for Toolbox E0 202



Mounting Hit tube code	20 BOX				40 FT HC				TRUCK						
	pallet size mm.			pieces per pallet	Tot. pallet	pallet size mm.			pieces per pallet	Tot. pallet	pallet size mm.			pieces per pallet	Tot. pallet
	L	H	D			L	H	D			L	H	D		
cod. ED 960 02	1330	555	1065	60	2	1330	555	1065	65	5	1330	725	1065	85	5
cod. ED 960 04	1330	555	1065	60	2	1330	640	1065	65	5	1330	980	1065	85	5
cod. ED 960 06/08	1330	725	1065	60	2	1330	810	1065	65	5	1330	980	1065	85	5

Shipment_Fast Mounting for Toolbox E0 252



Mounting Hit tube code	20 BOX				40 FT HC				TRUCK						
	pallet size mm.			pieces per pallet	Tot. pallet	pallet size mm.			pieces per pallet	Tot. pallet	pallet size mm.			pieces per pallet	Tot. pallet
	L	H	D			L	H	D			L	H	D		
cod. ED 960 02	1100	555	840	48	2	1330	640	1065	60	4	1100	725	840	70	4
cod. ED 960 04	1100	725	840	48	2	1330	895	1065	60	4	1100	980	840	70	4
cod. ED 960 06/08	1100	725	840	48	2	1100	895	840	60	4	1100	980	840	70	4

Shipment_Fast Mounting for Toolbox E0 302



Mounting Hit tube code	20 BOX				40 FT HC				TRUCK						
	pallet size mm.			pieces per pallet	Tot. pallet	pallet size mm.			pieces per pallet	Tot. pallet	pallet size mm.			pieces per pallet	Tot. pallet
	L	H	D			L	H	D			L	H	D		
cod. ED 960 02	1060	640	1060	72	1	1060	640	1060	63	2	1060	640	1060	70	3
						1060	640	1060	64	1					
cod. ED 960 04	1060	1065	1060	72	1	1060	895	1060	63	2	1060	980	1060	70	3
						1060	980	1060	64	1					
cod. ED 960 06/08	1060	1065	1060	72	1	1060	895	1060	63	2	1060	980	1060	70	3
						1060	980	1060	64	1					



Assembly Steps_Adj. Fast Mounting

Step_1 Make two holes in the truck chassis and screw the fast connection tubes without tightening.

Step_2 Insert the toolbox until it stops (CLICK) and tighten the screw.

Step_3 Open the toolbox and insert the safety plugs.

Assembly completed.

Step_1

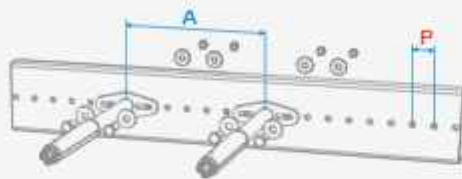

For Toolbox length	A	B	C	E	F
500	354	68	180	45	13
600	430	80	195	52	13
800	621	90	195	52	13
1000	811	80	195	52	13

Step_2

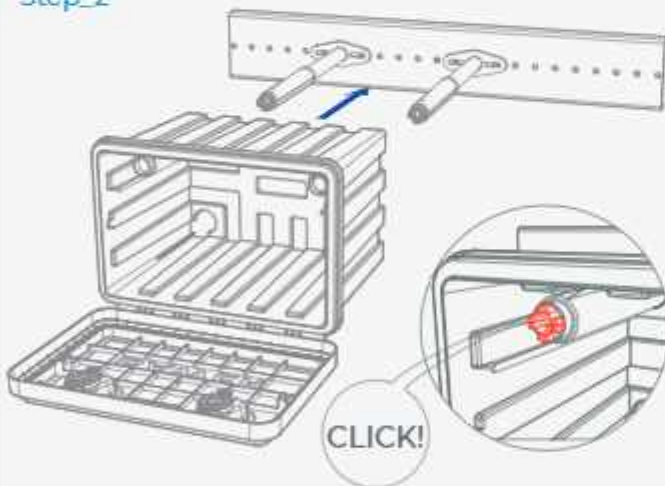

Step_3



Technical Features_Adj. ast Mounting

SUITABLE FOR CHASSIS WITH PRE-DRILLED HOLES
P: from 40 to 60 mm



Black Powder Coated Steel Tube

TUBE - A



short, medium and long tube

TUBE - B



customized tube with multi holes

FEATURES TUBE - B

Check which distance "Y" you need and cut as show below. After cutting it is recommended to use an anticorrosive paint.

EXAMPLE OF CUTTING TUBE



EXAMPLE OF ASSEMBLED TUBE

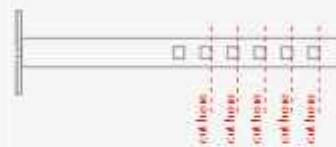

- Screw TE M12x50 ZNB
4 pcs
- Washer M12 ZNB
8 pcs
- Self-blocking nut M12
4 pcs

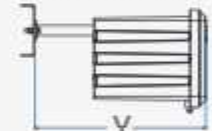

For Toolbox code	Tube diameter	A mm.	Fast Mounting Tube code	Y TUBE - A	Y TUBE - B
cod. E0 142 L 500 x H 365 x D 300	ø 30	354	E0 951 02 - Short Tube	Y1: 424 mm.	Y1: 604 mm.
			E0 951 04 - Medium Tube	Y1: 534 mm.	Y2: 576 mm.
			E0 951 06 - Long tube	Y1: 644 mm.	Y3: 548 mm.
			E0 951 08 - Customized Tube	Y: TUBE - B	Y4: 520 mm.
cod. E0 152 L 500 x H 365 x D 400	ø 30	354	E0 951 12 - Short Tube	Y1: 424 mm.	Y5: 492 mm.
			E0 951 14 - Medium Tube	Y1: 534 mm.	Y6: 464 mm.
			E0 951 16 - Long tube	Y1: 644 mm.	
			E0 951 18 - Customized Tube	Y: TUBE - B	
cod. E0 202 L 600 x H 425 x D 460	ø 42	430	E0 961 02 - Short Tube	Y1: 582 mm.	Y1: 798 mm.
			E0 961 04 - Medium Tube	Y1: 702 mm.	Y2: 770 mm.
			E0 961 06 - Long tube	Y1: 822 mm.	Y3: 742 mm.
			E0 961 08 - Customized Tube	Y: TUBE - B	Y4: 714 mm.
cod. E0 252 L 800 x H 500 x D 460	ø 42	621	E0 961 02 - Short Tube	Y1: 582 mm.	Y5: 686 mm.
			E0 961 04 - Medium Tube	Y1: 702 mm.	Y6: 658 mm.
			E0 961 06 - Long tube	Y1: 822 mm.	Y7: 630 mm.
			E0 961 08 - Customized Tube	Y: TUBE - B	
cod. E0 302 L 1000 x H 500 x D 460	ø 42	811	E0 961 02 - Short Tube	Y1: 582 mm.	Y8: 602 mm.
			E0 961 04 - Medium Tube	Y1: 702 mm.	Y9: 574 mm.
			E0 961 06 - Long tube	Y1: 822 mm.	Y10: 546 mm.
			E0 961 08 - Customized Tube	Y: TUBE - B	



Packaging & Shipment_Adj. Fast Mounting



Shipment_Adjustable Fast Mounting for Toolbox E0 142



Mounting Hit tube code	20 BOX				40 FT HC				TRUCK						
	pallet size mm.			pieces per pallet	Tot. pallet	pallet size mm.			pieces per pallet	Tot. pallet	pallet size mm.			pieces per pallet	Tot. pallet
	L	H	D			L	H	D			L	H	D		
cod. E0 951 02	1140	1255	1040	144	2	1140	1030	1040	112	6	1140	955	1040	108	8
cod. E0 951 04	1140	1480	1040	144	2	1140	1180	1040	112	6	1140	1180	1040	108	8
cod. E0 951 06/08	1140	1930	1040	144	2	1140	1555	1040	112	6	1140	1480	1040	108	8

Shipment_Adjustable Fast Mounting for Toolbox E0 152



Mounting Hit tube code	20 BOX				40 FT HC				TRUCK						
	pallet size mm.			pieces per pallet	Tot. pallet	pallet size mm.			pieces per pallet	Tot. pallet	pallet size mm.			pieces per pallet	Tot. pallet
	L	H	D			L	H	D			L	H	D		
cod. E0 951 12	1140	1030	1040	120	2	1140	1180	1040	135	4	1140	1030	1040	120	4
cod. E0 951 14	1140	1255	1040	120	2	1140	1405	1040	135	4	1140	1255	1040	120	4
cod. E0 951 16/18	1140	1630	1040	120	2	1140	1855	1040	135	4	1140	1630	1040	120	4

Shipment_Adjustable Fast Mounting for Toolbox E0 202



Mounting Hit tube code	20 BOX				40 FT HC				TRUCK						
	pallet size mm.			pieces per pallet	Tot. pallet	pallet size mm.			pieces per pallet	Tot. pallet	pallet size mm.			pieces per pallet	Tot. pallet
	L	H	D			L	H	D			L	H	D		
cod. E0 961 02	1330	640	1065	60	2	1330	725	1065	65	5	1330	895	1065	85	5
cod. E0 961 04	1330	895	1065	60	2	1330	980	1065	65	5	1330	1235	1065	85	5
cod. E0 961 06/08	1330	980	1065	60	2	1330	1065	1065	65	5	1330	1405	1065	85	5

Shipment_Adjustable Fast Mounting for Toolbox E0 252



Mounting Hit tube code	20 BOX				40 FT HC				TRUCK						
	pallet size mm.			pieces per pallet	Tot. pallet	pallet size mm.			pieces per pallet	Tot. pallet	pallet size mm.			pieces per pallet	Tot. pallet
	L	H	D			L	H	D			L	H	D		
cod. E0 961 02	1100	810	840	48	2	1100	980	840	60	4	1100	1150	840	70	4
cod. E0 961 04	1100	1150	840	48	2	1100	1405	840	60	4	1100	1660	840	70	4
cod. E0 961 06/08	1100	1150	840	48	2	1100	1405	840	60	4	1100	1660	840	70	4

Shipment_Adjustable Fast Mounting for Toolbox E0 302



Mounting Hit tube code	20 BOX				40 FT HC				TRUCK						
	pallet size mm.			pieces per pallet	Tot. pallet	pallet size mm.			pieces per pallet	Tot. pallet	pallet size mm.			pieces per pallet	Tot. pallet
	L	H	D			L	H	D			L	H	D		
cod. E0 961 02	1060	895	1060	72	1	1060	810	1060	64	2	1060	895	1060	70	3
						1060	810	1060	63	1					
cod. E0 961 04	1060	1405	1060	72	1	1060	1235	1060	63	2	1060	1320	1060	70	3
						1060	1235	1060	64	1					
cod. E0 961 06/08	1060	1405	1060	72	1	1060	1235	1060	63	2	1060	1320	1060	70	3
						1060	1235	1060	64	1					

BAWVER

Fire Extinguisher Box



Technical Features



Easy_fire extinguisher box

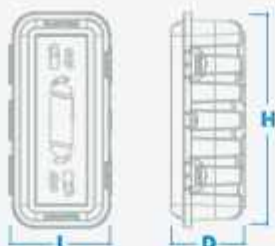

extinguisher box code	size mm.			weight Hg	extinguisher diameter
	L	H	D		
cod. E0 80 2 00	280	620	215	2,08	160

Logistic

	pallet size mm.			pieces per pallet	Tot. pallet
	L	H	D		
20 BOX	1300	2071	970	108	10
40 FT HC	1300	2482	970	126	21
TRUCK	1300	2683	970	144	24

Basic_fire extinguisher box

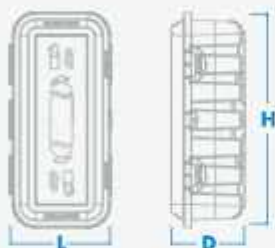

extinguisher box code	size mm.			weight Hg	extinguisher diameter
	L	H	D		
cod. E0 80 2	280	620	215	2,08	160

Logistic

	pallet size mm.			pieces per pallet	Tot. pallet
	L	H	D		
20 BOX	1300	2200	970	54	10
40 FT HC	1300	2430	970	60	21
TRUCK	1300	2660	970	66	24

Easy Plus_fire extinguisher box

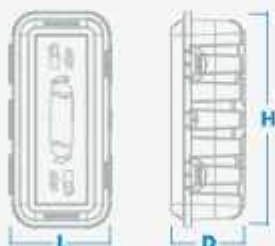

extinguisher box code	size mm.			weight Hg	extinguisher diameter
	L	H	D		
cod. E0 80 4 00	280	620	215	2,08	160

Logistic

	pallet size mm.			pieces per pallet	Tot. pallet
	L	H	D		
20 BOX	1300	2098	970	54	10
40 FT HC	1300	2098	970	54	21
TRUCK	1300	2098	970	54	24

Premium_fire extinguisher box



extinguisher box code	size mm.			weight Hg	extinguisher diameter
	L	H	D		
cod. E0 80 4	280	620	215	2,08	160

Logistic

	pallet size mm.			pieces per pallet	Tot. pallet
	L	H	D		
20 BOX	1300	2140	970	36	10
40 FT HC	1300	2370	970	39	21
TRUCK	1300	2600	970	43	24



Bracket & Ring-Holder

Extinguisher Box



Assembly Steps_Fast Mounting

Step_1 Secure the bracket to the corresponding fixing holes of vehicle landing leg.



Step_2 Fix the fire extinguisher box to the bracket following the instructions below:

1. hook the fire extinguisher box to the upper wings of the bracket
2. push the fire extinguisher box and be guided by the side wings of the bracket

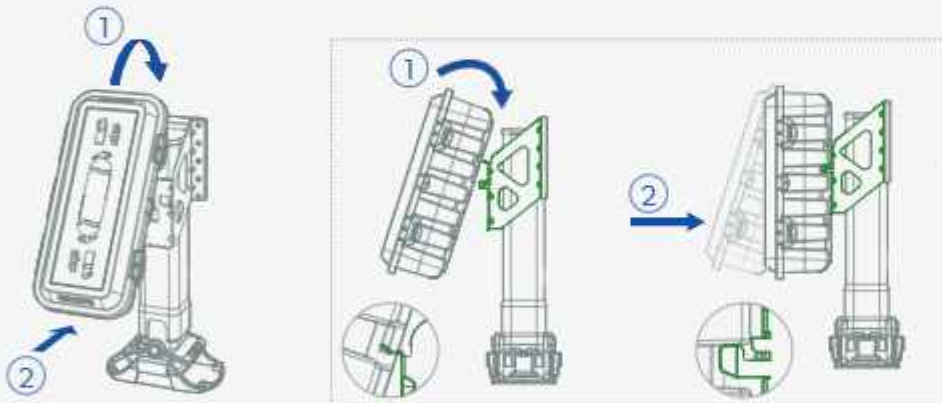

Step_3 Secure the fire extinguisher box to the bracket by following the instructions below:

1. insert the fire extinguisher ring into the central hole of the box body
2. turn the fire extinguisher ring until it stops (as shown in point 3)
3. Assembled completed

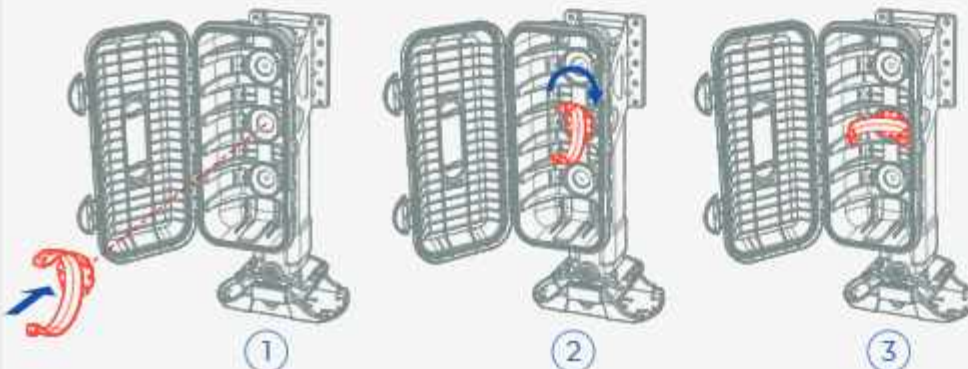

Ring-Holder

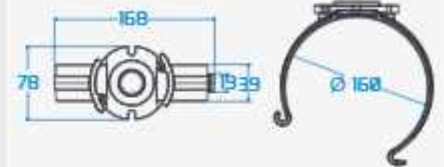

Ring-Holder for fire extinguisher of 6 Kg.

Fast Mounting Ring-Holder

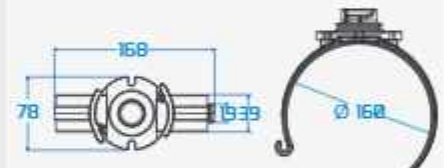

Ring-Holder for Fire extinguisher of 6 Kg.

Rubber Clamp



Fast Mounting Bracket

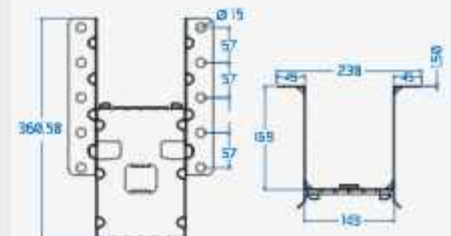

Metal Toolboxes



BAWWE



SR

Technical Features

Basic_toolboxes



toolbox code	toolbox size mm.			toolbox weight kg	load capacity kg
	L	H	D		
cod. E2 150	500	350	400	8,1	60
cod. E2 200	600	400	500	11,5	75



toolbox code	toolbox size mm.			toolbox weight kg	load capacity kg
	L	H	D		
cod. E2 250	800	500	500	19	83
cod. E2 300	1000	500	500	23	90

Plus_toolboxes



toolbox code	toolbox size mm.			toolbox weight kg	load capacity kg
	L	H	D		
cod. E2 151	500	350	400	10,1	60
cod. E2 201	600	400	500	14	75



toolbox code	toolbox size mm.			toolbox weight kg	load capacity kg
	L	H	D		
cod. E2 251	800	500	500	22	83
cod. E2 301	1000	500	500	26,5	90

Smart_toolboxes



toolbox code	toolbox size mm.			toolbox weight kg	load capacity kg
	L	H	D		
cod. E2 152	500	350	400	10,1	60
cod. E2 202	600	400	500	14	75



toolbox code	toolbox size mm.			toolbox weight kg	load capacity kg
	L	H	D		
cod. E2 252	800	500	500	22	83
cod. E2 302	1000	500	500	26,5	90

Premium_toolboxes



toolbox code	toolbox size mm.			toolbox weight kg	load capacity kg
	L	H	D		
cod. E2 153	500	350	400	10,6	60
cod. E2 203	600	400	500	15	75



toolbox code	toolbox size mm.			toolbox weight kg	load capacity kg
	L	H	D		
cod. E2 253	800	500	500	23	83
cod. E2 303	1000	500	500	27	90

Basic_shipment with cardboard



toolbox code	20 BOX			pieces per pallet	Tot. pallet	40 FT HC			pieces per pallet	Tot. pallet	TRUCK			pieces per pallet	Tot. pallet
	pallet size mm.					pallet size mm.					pallet size mm.				
	L	H	D			L	H	D			L	H	D		
cod. E2 150	1100	2000	1400	30	8	1100	2400	1400	36	16	1100	2400	1400	36	18
cod. E2 200	1100	2250	1250	20	8	1100	2250	1250	20	18	1100	2680	1250	24	22
cod. E2 250	830	2250	1080	8	14	830	2250	1080	8	28	830	2250	1080	8	32
cod. E2 300	1060	2250	1060	8	10	1060	2250	1060	8	22	1060	2250	1060	8	24

Plus_shipment with cardboard



toolbox code	20 BOX			pieces per pallet	Tot. pallet	40 FT HC			pieces per pallet	Tot. pallet	TRUCK			pieces per pallet	Tot. pallet
	pallet size mm.					pallet size mm.					pallet size mm.				
	L	H	D			L	H	D			L	H	D		
cod. E2 151	1100	2000	1400	30	8	1100	2400	1400	36	16	1100	2400	1400	36	18
cod. E2 201	1100	2250	1250	20	8	1100	2250	1250	20	18	1100	2680	1250	24	22
cod. E2 251	830	2250	1080	8	14	830	2250	1080	8	28	830	2250	1080	8	32
cod. E2 301	1060	2250	1060	8	10	1060	2250	1060	8	22	1060	2250	1060	8	24

Smart_shipment with cardboard



toolbox code	20 BOX			pieces per pallet	Tot. pallet	40 FT HC			pieces per pallet	Tot. pallet	TRUCK			pieces per pallet	Tot. pallet
	pallet size mm.					pallet size mm.					pallet size mm.				
	L	H	D			L	H	D			L	H	D		
cod. E2 152	1100	2000	1400	30	6+2*	1100	2400	1400	36	12+4*	1100	2400	1400	36	14+4*
cod. E2 202	1100	2250	1250	20	6+2*	1100	2250	1250	20	14+4*	1100	2680	1250	24	18+4*
cod. E2 252	1100	2250	840	8	13+1*	1100	2250	840	8	26+2*	1100	2250	840	8	28+4*
cod. E2 302	1060	2250	1060	8	9+1*	1060	2250	1060	8	20+2*	1060	2250	1060	8	22+2*

*Total number of pallets with Fast Mounting kit to satisfy the total number of toolboxes pallets

Premium_shipment with cardboard



toolbox code	20 BOX			pieces per pallet	Tot. pallet	40 FT HC			pieces per pallet	Tot. pallet	TRUCK			pieces per pallet	Tot. pallet
	pallet size mm.					pallet size mm.					pallet size mm.				
	L	H	D			L	H	D			L	H	D		
cod. E2 153	1100	2000	1400	30	6+2*	1100	2400	1400	36	12+4*	1100	2400	1400	36	14+4*
cod. E2 203	1100	2250	1250	20	6+2*	1100	2250	1250	20	14+4*	1100	2680	1250	24	18+4*
cod. E2 253	1100	2250	840	8	13+1*	1100	2250	840	8	26+2*	1100	2250	840	8	28+4*
cod. E2 303	1060	2250	1060	8	9+1*	1060	2250	1060	8	20+2*	1060	2250	1060	8	22+2*

*Total number of pallets with Fast Mounting kit to satisfy the total number of toolboxes pallets



Basic_toolboxes

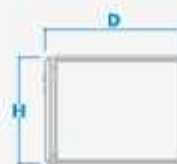
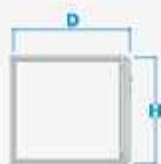

toolbox code	toolbox size mm.			toolbox weight Kg	load capacity Kg
	L	H	D		
cod. E4 150	500	350	400	6,0	60
cod. E4 200	600	400	500	8,5	75

toolbox code	toolbox size mm.			toolbox weight Kg	load capacity Kg
	L	H	D		
cod. E4 250	800	500	500	12	83
cod. E4 300	1000	500	500	15	90

Plus_toolboxes

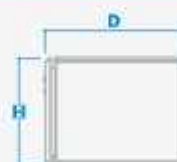
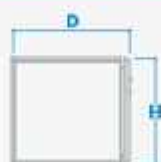

toolbox code	toolbox size mm.			toolbox weight Kg	load capacity Kg
	L	H	D		
cod. E4 151	500	350	400	8	60
cod. E4 201	600	400	500	11	75

toolbox code	toolbox size mm.			toolbox weight Kg	load capacity Kg
	L	H	D		
cod. E4 251	800	500	500	15	83
cod. E4 301	1000	500	500	18,5	90

Smart_toolboxes

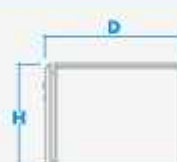
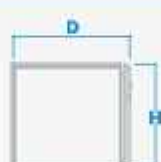

toolbox code	toolbox size mm.			toolbox weight Kg	load capacity Kg
	L	H	D		
cod. E4 152	500	350	400	8	60
cod. E4 202	600	400	500	11	75

toolbox code	toolbox size mm.			toolbox weight Kg	load capacity Kg
	L	H	D		
cod. E4 252	800	500	500	15	83
cod. E4 302	1000	500	500	18,5	90

Premium_toolboxes

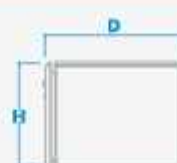
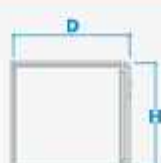

toolbox code	toolbox size mm.			toolbox weight Kg	load capacity Kg
	L	H	D		
cod. E4 153	500	350	400	8,5	60
cod. E4 203	600	400	500	12	75

toolbox code	toolbox size mm.			toolbox weight Kg	load capacity Kg
	L	H	D		
cod. E4 253	800	500	500	16	83
cod. E4 303	1000	500	500	19	90



Basic_shipment with cardboard



toolbox code	20 BOX			pieces per pallet	Tot. pallet	40 FT HC			pieces per pallet	Tot. pallet	TRUCK			pieces per pallet	Tot. pallet
	pallet size mm.					pallet size mm.					pallet size mm.				
	L	H	D			L	H	D			L	H	D		
cod. E4 150	1100 x 2000 x 1400			30	8	1100 x 2400 x 1400			36	16	1100 x 2400 x 1400			36	18
cod. E4 200	1100 x 2250 x 1250			20	8	1100 x 2250 x 1250			20	18	1100 x 2680 x 1250			24	22
cod. E4 250	830 x 2250 x 1080			8	14	830 x 2250 x 1080			8	28	830 x 2250 x 1080			8	32
cod. E4 300	1060 x 2250 x 1060			8	10	1060 x 2250 x 1060			8	22	1060 x 2250 x 1060			8	24

Plus_shipment with cardboard



toolbox code	20 BOX			pieces per pallet	Tot. pallet	40 FT HC			pieces per pallet	Tot. pallet	TRUCK			pieces per pallet	Tot. pallet
	pallet size mm.					pallet size mm.					pallet size mm.				
	L	H	D			L	H	D			L	H	D		
cod. E4 151	1100 x 2000 x 1400			30	8	1100 x 2400 x 1400			36	16	1100 x 2400 x 1400			36	18
cod. E4 201	1100 x 2250 x 1250			20	8	1100 x 2250 x 1250			20	18	1100 x 2680 x 1250			24	22
cod. E4 251	830 x 2250 x 1080			8	14	830 x 2250 x 1080			8	28	830 x 2250 x 1080			8	32
cod. E4 301	1060 x 2250 x 1060			8	10	1060 x 2250 x 1060			8	22	1060 x 2250 x 1060			8	24

Smart_shipment with cardboard



toolbox code	20 BOX			pieces per pallet	Tot. pallet	40 FT HC			pieces per pallet	Tot. pallet	TRUCK			pieces per pallet	Tot. pallet
	pallet size mm.					pallet size mm.					pallet size mm.				
	L	H	D			L	H	D			L	H	D		
cod. E4 152	1100 x 2000 x 1400			30	6+2*	1100 x 2400 x 1400			36	12+4*	1100 x 2400 x 1400			36	14+4*
cod. E4 202	1100 x 2250 x 1250			20	6+2*	1100 x 2250 x 1250			20	14+4*	1100 x 2680 x 1250			24	18+4*
cod. E4 252	1100 x 2250 x 840			8	13+1*	1100 x 2250 x 840			8	26+2*	1100 x 2250 x 840			8	28+4*
cod. E4 302	1060 x 2250 x 1060			8	9+1*	1060 x 2250 x 1060			8	20+2*	1060 x 2250 x 1060			8	22+2*

*Total number of pallets with Fast Mounting kit to satisfy the total number of toolboxes pallets

Premium_shipment with cardboard



toolbox code	20 BOX			pieces per pallet	Tot. pallet	40 FT HC			pieces per pallet	Tot. pallet	TRUCK			pieces per pallet	Tot. pallet
	pallet size mm.					pallet size mm.					pallet size mm.				
	L	H	D			L	H	D			L	H	D		
cod. E4 153	1100 x 2000 x 1400			30	6+2*	1100 x 2400 x 1400			36	12+4*	1100 x 2400 x 1400			36	14+4*
cod. E4 203	1100 x 2250 x 1250			20	6+2*	1100 x 2250 x 1250			20	14+4*	1100 x 2680 x 1250			24	18+4*
cod. E4 253	1100 x 2250 x 840			8	13+1*	1100 x 2250 x 840			8	26+2*	1100 x 2250 x 840			8	28+4*
cod. E4 303	1060 x 2250 x 1060			8	9+1*	1060 x 2250 x 1060			8	20+2*	1060 x 2250 x 1060			8	22+2*

*Total number of pallets with Fast Mounting kit to satisfy the total number of toolboxes pallets

Basic_toolboxes



toolbox code	toolbox size mm.			toolbox weight Kg	load capacity Kg
	L	H	D		
cod. E6 150	500	350	400	8,1	70
cod. E6 200	600	400	500	11,5	85



toolbox code	toolbox size mm.			toolbox weight Kg	load capacity Kg
	L	H	D		
cod. E6 250	800	500	500	19	92
cod. E6 300	1000	500	500	23	99

Plus_toolboxes



toolbox code	toolbox size mm.			toolbox weight Kg	load capacity Kg
	L	H	D		
cod. E6 151	500	350	400	10,1	70
cod. E6 201	600	400	500	14	85



toolbox code	toolbox size mm.			toolbox weight Kg	load capacity Kg
	L	H	D		
cod. E6 251	800	500	500	22	92
cod. E6 301	1000	500	500	26,5	99

Smart_toolboxes



toolbox code	toolbox size mm.			toolbox weight Kg	load capacity Kg
	L	H	D		
cod. E6 152	500	350	400	10,1	70
cod. E6 202	600	400	500	14	85



toolbox code	toolbox size mm.			toolbox weight Kg	load capacity Kg
	L	H	D		
cod. E6 252	800	500	500	22	92
cod. E6 302	1000	500	500	26,5	99

Premium_toolboxes



toolbox code	toolbox size mm.			toolbox weight Kg	load capacity Kg
	L	H	D		
cod. E6 153	500	350	400	10,6	70
cod. E6 203	600	400	500	15	85



toolbox code	toolbox size mm.			toolbox weight Kg	load capacity Kg
	L	H	D		
cod. E6 253	800	500	500	23	92
cod. E6 303	1000	500	500	27	99

Basic_shipment with cardboard



toolbox code	20 BOX			pieces per pallet	Tot. pallet	40 FT HC			pieces per pallet	Tot. pallet	TRUCK			pieces per pallet	Tot. pallet
	pallet size mm.					pallet size mm.					pallet size mm.				
	L	H	D			L	H	D			L	H	D		
cod. E6 150	1100	2000	1400	30	8	1100	2400	1400	36	16	1100	2400	1400	36	18
cod. E6 200	1100	2250	1250	20	8	1100	2250	1250	20	18	1100	2680	1250	24	22
cod. E6 250	830	2250	1080	8	14	830	2250	1080	8	28	830	2250	1080	8	32
cod. E6 300	1060	2250	1060	8	10	1060	2250	1060	8	22	1060	2250	1060	8	24

Plus_shipment with cardboard



toolbox code	20 BOX			pieces per pallet	Tot. pallet	40 FT HC			pieces per pallet	Tot. pallet	TRUCK			pieces per pallet	Tot. pallet
	pallet size mm.					pallet size mm.					pallet size mm.				
	L	H	D			L	H	D			L	H	D		
cod. E6 151	1100	2000	1400	30	8	1100	2400	1400	36	16	1100	2400	1400	36	18
cod. E6 201	1100	2250	1250	20	8	1100	2250	1250	20	18	1100	2680	1250	24	22
cod. E6 251	830	2250	1080	8	14	830	2250	1080	8	28	830	2250	1080	8	32
cod. E6 301	1060	2250	1060	8	10	1060	2250	1060	8	22	1060	2250	1060	8	24

Smart_shipment with cardboard



toolbox code	20 BOX			pieces per pallet	Tot. pallet	40 FT HC			pieces per pallet	Tot. pallet	TRUCK			pieces per pallet	Tot. pallet
	pallet size mm.					pallet size mm.					pallet size mm.				
	L	H	D			L	H	D			L	H	D		
cod. E6 152	1100	2000	1400	30	6+2*	1100	2400	1400	36	12+4*	1100	2400	1400	36	14+4*
cod. E6 202	1100	2250	1250	20	6+2*	1100	2250	1250	20	14+4*	1100	2680	1250	24	18+4*
cod. E6 252	1100	2250	840	8	13+1*	1100	2250	840	8	26+2*	1100	2250	840	8	28+4*
cod. E6 302	1060	2250	1060	8	9+1*	1060	2250	1060	8	20+2*	1060	2250	1060	8	22+2*

*Total number of pallets with Fast Mounting kit to satisfy the total number of toolboxes pallets

Premium_shipment with cardboard



toolbox code	20 BOX			pieces per pallet	Tot. pallet	40 FT HC			pieces per pallet	Tot. pallet	TRUCK			pieces per pallet	Tot. pallet
	pallet size mm.					pallet size mm.					pallet size mm.				
	L	H	D			L	H	D			L	H	D		
cod. E6 153	1100	2000	1400	30	6+2*	1100	2400	1400	36	12+4*	1100	2400	1400	36	14+4*
cod. E6 203	1100	2250	1250	20	6+2*	1100	2250	1250	20	14+4*	1100	2680	1250	24	18+4*
cod. E6 253	1100	2250	840	8	13+1*	1100	2250	840	8	26+2*	1100	2250	840	8	28+4*
cod. E6 303	1060	2250	1060	8	9+1*	1060	2250	1060	8	20+2*	1060	2250	1060	8	22+2*

*Total number of pallets with Fast Mounting kit to satisfy the total number of toolboxes pallets

Basic_toolboxes



toolbox code	toolbox size mm.			toolbox weight Kg	load capacity Kg
	L	H	D		
cod. EB 150	500	350	400	8,1	70
cod. EB 200	600	400	500	11,5	85



toolbox code	toolbox size mm.			toolbox weight Kg	load capacity Kg
	L	H	D		
cod. EB 250	800	500	500	19	92
cod. EB 300	1000	500	500	23	99

Plus_toolboxes



toolbox code	toolbox size mm.			toolbox weight Kg	load capacity Kg
	L	H	D		
cod. EB 151	500	350	400	10,1	70
cod. EB 201	600	400	500	14	85



toolbox code	toolbox size mm.			toolbox weight Kg	load capacity Kg
	L	H	D		
cod. EB 251	800	500	500	22	92
cod. EB 301	1000	500	500	26,5	99

Smart_toolboxes



toolbox code	toolbox size mm.			toolbox weight Kg	load capacity Kg
	L	H	D		
cod. EB 152	500	350	400	10,1	70
cod. EB 202	600	400	500	14	85



toolbox code	toolbox size mm.			toolbox weight Kg	load capacity Kg
	L	H	D		
cod. EB 252	800	500	500	22	92
cod. EB 302	1000	500	500	26,5	99

Premium_toolboxes



toolbox code	toolbox size mm.			toolbox weight Kg	load capacity Kg
	L	H	D		
cod. EB 153	500	350	400	10,6	70
cod. EB 203	600	400	500	15	85



toolbox code	toolbox size mm.			toolbox weight Kg	load capacity Kg
	L	H	D		
cod. EB 253	800	500	500	23	92
cod. EB 303	1000	500	500	27	99

Basic_shipment with cardboard



toolbox code	20 BOX			pieces per pallet	Tot. pallet	40 FT HC			pieces per pallet	Tot. pallet	TRUCK			pieces per pallet	Tot. pallet
	pallet size mm.					pallet size mm.					pallet size mm.				
	L	H	D			L	H	D			L	H	D		
cod. EB 150	1100	2000	1400	30	8	1100	2400	1400	36	16	1100	2400	1400	36	18
cod. EB 200	1100	2250	1250	20	8	1100	2250	1250	20	18	1100	2680	1250	24	22
cod. EB 250	830	2250	1080	8	14	830	2250	1080	8	28	830	2250	1080	8	32
cod. EB 300	1060	2250	1060	8	10	1060	2250	1060	8	22	1060	2250	1060	8	24

Plus_shipment with cardboard



toolbox code	20 BOX			pieces per pallet	Tot. pallet	40 FT HC			pieces per pallet	Tot. pallet	TRUCK			pieces per pallet	Tot. pallet
	pallet size mm.					pallet size mm.					pallet size mm.				
	L	H	D			L	H	D			L	H	D		
cod. EB 151	1100	2000	1400	30	8	1100	2400	1400	36	16	1100	2400	1400	36	18
cod. EB 201	1100	2250	1250	20	8	1100	2250	1250	20	18	1100	2680	1250	24	22
cod. EB 251	830	2250	1080	8	14	830	2250	1080	8	28	830	2250	1080	8	32
cod. EB 301	1060	2250	1060	8	10	1060	2250	1060	8	22	1060	2250	1060	8	24

Smart_shipment with cardboard



toolbox code	20 BOX			pieces per pallet	Tot. pallet	40 FT HC			pieces per pallet	Tot. pallet	TRUCK			pieces per pallet	Tot. pallet
	pallet size mm.					pallet size mm.					pallet size mm.				
	L	H	D			L	H	D			L	H	D		
cod. EB 152	1100	2000	1400	30	6+2*	1100	2400	1400	36	12+4*	1100	2400	1400	36	14+4*
cod. EB 202	1100	2250	1250	20	6+2*	1100	2250	1250	20	14+4*	1100	2680	1250	24	18+4*
cod. EB 252	1100	2250	840	8	13+1*	1100	2250	840	8	26+2*	1100	2250	840	8	28+4*
cod. EB 302	1060	2250	1060	8	9+1*	1060	2250	1060	8	20+2*	1060	2250	1060	8	22+2*

*Total number of pallets with Fast Mounting kit to satisfy the total number of toolboxes pallets

Premium_shipment with cardboard



toolbox code	20 BOX			pieces per pallet	Tot. pallet	40 FT HC			pieces per pallet	Tot. pallet	TRUCK			pieces per pallet	Tot. pallet
	pallet size mm.					pallet size mm.					pallet size mm.				
	L	H	D			L	H	D			L	H	D		
cod. EB 153	1100	2000	1400	30	6+2*	1100	2400	1400	36	12+4*	1100	2400	1400	36	14+4*
cod. EB 203	1100	2250	1250	20	6+2*	1100	2250	1250	20	14+4*	1100	2680	1250	24	18+4*
cod. EB 253	1100	2250	840	8	13+1*	1100	2250	840	8	26+2*	1100	2250	840	8	28+4*
cod. EB 303	1060	2250	1060	8	9+1*	1060	2250	1060	8	20+2*	1060	2250	1060	8	22+2*

*Total number of pallets with Fast Mounting kit to satisfy the total number of toolboxes pallets

Brackets & Fast Mounting



METAL Toolbox

Short Horizontal Brackets

cod. E0 990 02 - Black, Powder Coated Brackets

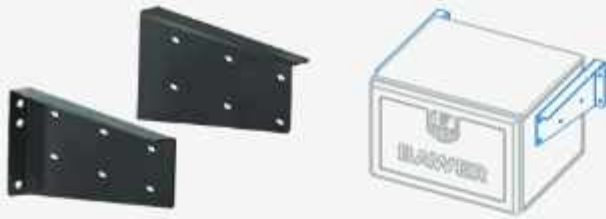

- Hex-head screws M8x25, 8 pcs
- Washer M8, 8 pcs
- Self-blocking nuts M8, 8 pcs

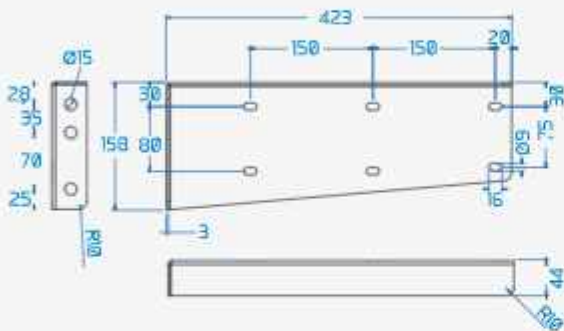

cod. E6 990 02 - Stainless Steel Brackets



- Hex-head screws M8x25, 8 pcs
- Washer M8, 8 pcs
- Self-blocking nuts M8, 8 pcs

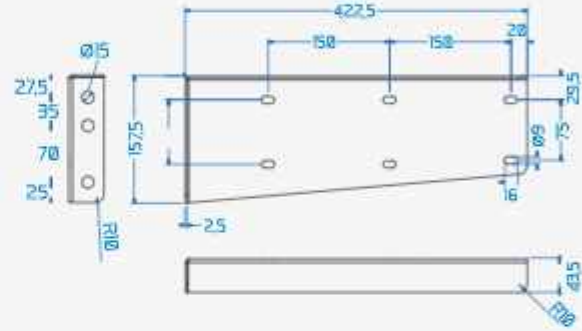

Long Horizontal Brackets

cod. E0 990 04 - Black, Powder Coated Brackets



- Hex-head screws M8x25, 8 pcs
- Washer M8, 8 pcs
- Self-blocking nuts M8, 8 pcs

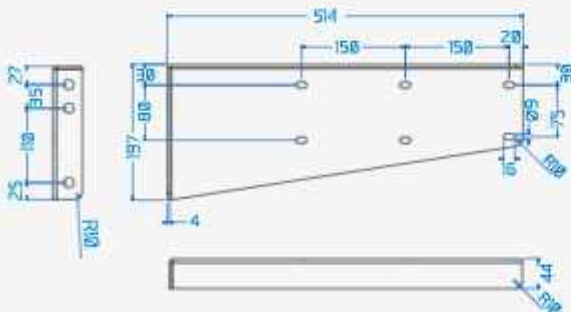

cod. E6 990 04 - Stainless Steel Brackets



- Hex-head screws M8x25, 8 pcs
- Washer M8, 8 pcs
- Self-blocking nuts M8, 8 pcs

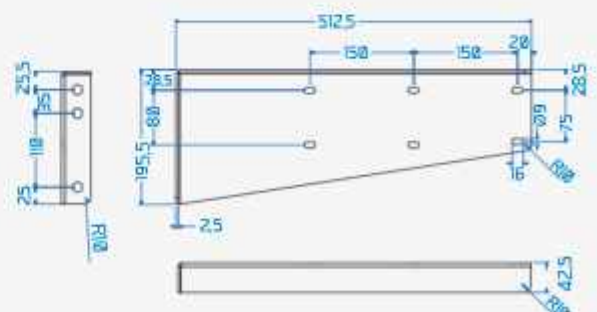

Vertical Brackets

cod. E0 990 06 - Galvanized Steel Brackets



- Hex-head screws M8x25, 8 pcs
- Washer M8, 8 pcs
- Self-blocking nuts M8, 8 pcs

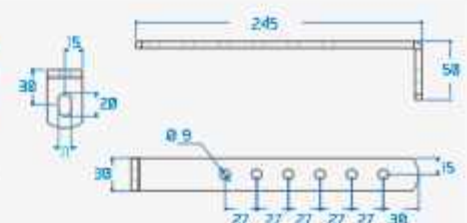

Assembly Steps_Fast Mounting

Step_1 Make two holes in the truck chassis and screw the fast connection tubes without tightening.

Step_2 Insert the toolbox until it stops and tighten the screw.

Step_3 Open the toolbox and insert the safety hooks.

Assembly completed.

Step_1

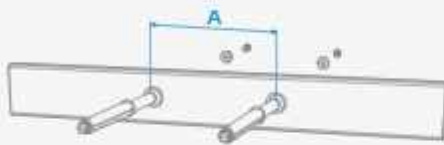

Step_2

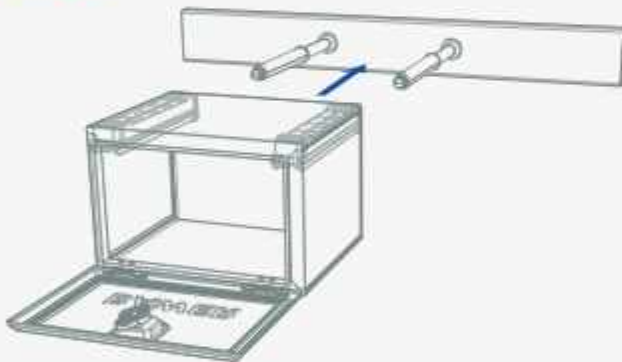

Step_3

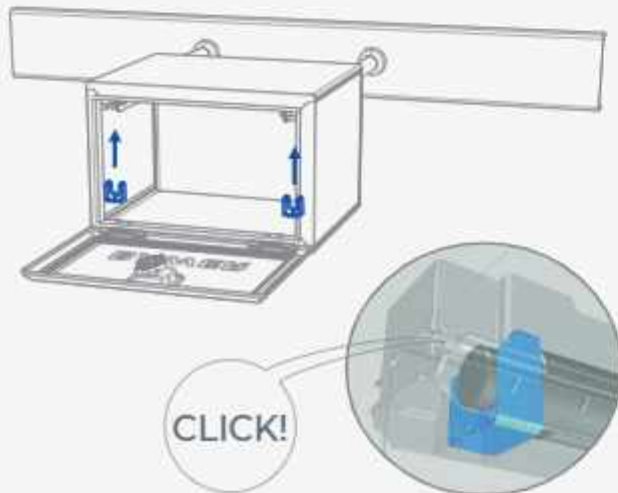

Technical Features_Fast Mounting



Black Powder Coated Steel Tube

TUBE - A



short, medium and long tube

TUBE - B



customized tube with multi holes

FEATURES TUBE - B

Check which distance "Y" you need and cut as show below. After cutting it is recommended to use an anticorrosive paint.

EXAMPLE OF CUTTING TUBE



EXAMPLE OF ASSEMBLED TUBE

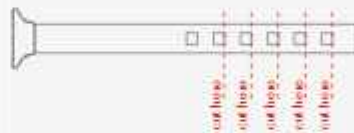

- Hex-head Screw M18
Fine pitch thread
- Washer M18
Wide strip

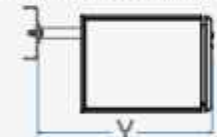

For Toolbox code	Tube diameter	A mm	Fast Mounting Tube code	Y TUBE - A	Y TUBE - B
cod. E2 152/153 cod. E4 152/153 cod. E6 152/153 cod. E8 152/153 l. 500 x H. 350 x D. 400	ø 30	414	E2 950 02 - Short Tube	Y1: 434 mm	Y1: 614 mm
			E2 950 04 - Medium Tube	Y1: 544 mm	Y2: 586 mm
			E2 950 06 - Long tube	Y1: 654 mm	Y3: 558 mm
			E2 950 08 - Customized Tube	Y: TUBE - B	Y4: 530 mm Y5: 502 mm Y6: 474 mm
cod. E2 202/203 cod. E4 202/203 cod. E6 202/203 cod. E8 202/203 l. 600 x H. 400 x D. 500	ø 42	508	E2 960 02 - Short Tube	Y1: 582 mm	Y1: 798 mm
			E2 960 04 - Medium Tube	Y1: 702 mm	Y2: 770 mm
			E2 960 06 - Long tube	Y1: 822 mm	Y3: 742 mm
			E2 960 08 - Customized Tube	Y: TUBE - B	Y4: 714 mm
cod. E2 252/253 cod. E4 252/253 cod. E6 252/253 cod. E8 252/253 l. 800 x H. 500 x D. 500	ø 42	708	E2 960 02 - Short Tube	Y1: 582 mm	Y5: 686 mm
			E2 960 04 - Medium Tube	Y1: 702 mm	Y6: 658 mm
			E2 960 06 - Long tube	Y1: 822 mm	Y7: 630 mm
			E2 960 08 - Customized Tube	Y: TUBE - B	Y8: 602 mm
cod. E2 302/303 cod. E4 302/303 cod. E6 302/303 cod. E8 302/303 l. 1000 x H. 500 x D. 500	ø 42	908	E2 960 02 - Short Tube	Y1: 582 mm	Y9: 574 mm
			E2 960 04 - Medium Tube	Y1: 702 mm	Y10: 546 mm
			E2 960 06 - Long tube	Y1: 822 mm	
			E2 960 08 - Customized Tube	Y: TUBE - B	

Packaging & Shipment_Fast Mounting



Shipment_Fast Mounting for Toolboxes E2 152/153 - E4 152/153 - E6 152/153 - E8 152/153



toolboxes	20 BOX			40 FT HC			TRUCK		
	pallet size mm.			pallet size mm.			pallet size mm.		
Mounting Hit tube code	L	H	D	L	H	D	L	H	D
cod. E2 950 02	1100	430	1400	1100	505	1400	1100	505	1400
cod. E2 950 04	1100	505	1400	1100	580	1400	1100	655	1400
cod. E2 950 06	1100	580	1400	1100	655	1400	1100	730	1400
cod. E2 950 08	1100	580	1400	1100	655	1400	1100	730	1400

Shipment_Fast Mounting for Toolboxes E2 202/203 - E4 202/203 - E6 202/203 - E8 202/203



toolboxes	20 BOX			40 FT HC			TRUCK		
	pallet size mm.			pallet size mm.			pallet size mm.		
Mounting Hit tube code	L	H	D	L	H	D	L	H	D
cod. E2 960 02	1100	555	1250	1100	555	1250	1100	810	1250
cod. E2 960 04	1100	640	1250	1100	725	1250	1100	1065	1250
cod. E2 960 06	1100	810	1250	1100	895	1250	1100	1320	1250
cod. E2 960 08	1100	810	1250	1100	895	1250	1100	1320	1250

Shipment_Fast Mounting for Toolboxes E2 252/253 - E4 252/253 - E6 252/253 - E8 252/253



toolboxes	20 BOX			40 FT HC			TRUCK		
	pallet size mm.			pallet size mm.			pallet size mm.		
Mounting Hit tube code	L	H	D	L	H	D	L	H	D
cod. E2 960 02	1100	1065	840	1100	1065	840	1100	640	840
cod. E2 960 04	1100	1405	840	1100	1405	840	1100	810	840
cod. E2 960 06	1100	1405	840	1100	1405	840	1100	810	840
cod. E2 960 08	1100	1405	840	1100	1405	840	1100	810	840

Shipment_Fast Mounting for Toolboxes E2 302/303 - E4 302/303 - E6 302/303 - E8 302/303



toolboxes	20 BOX			40 FT HC			TRUCK		
	pallet size mm.			pallet size mm.			pallet size mm.		
Mounting Hit tube code	L	H	D	L	H	D	L	H	D
cod. E2 960 02	1060	640	1060	1060	725	1060	1060	1150	1060
cod. E2 960 04	1060	1065	1060	1060	1150	1060	1060	1235	1060
cod. E2 960 06	1060	1065	1060	1060	1150	1060	1060	1235	1060
cod. E2 960 08	1060	1065	1060	1060	1150	1060	1060	1235	1060

Assembly Steps_Adj. Fast Mounting

Step_1 Make two holes in the truck chassis and screw the fast connection tubes without tightening.

Step_2 Insert the toolbox until it stops and tighten the screw.

Step_3 Open the toolbox and insert the safety hooks.

Assembly completed.

Step_1

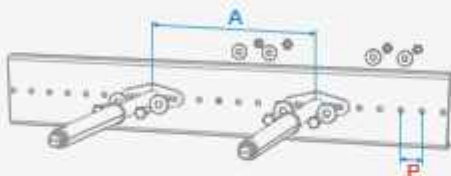

For Toolbox length	A	B	C	E	F
500	414	68	180	45	13
600	508	80	195	52	13
800	708	80	195	52	13
1000	908	80	195	52	13

Step_2

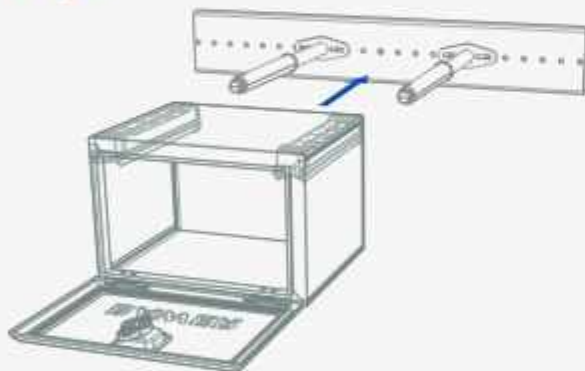

Step_3

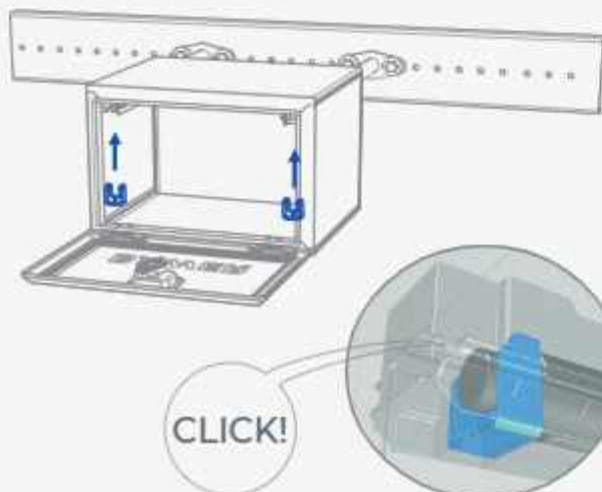

Technical Features_Adj. Fast Mounting

SUITABLE FOR CHASSIS WITH PRE-DRILLED HOLES
P: from 40 to 60 mm



Black Powder Coated Steel Tube

TUBE - A



short, medium and long tube

TUBE - B



customized tube with multi holes

FEATURES TUBE - B

Check which distance "Y" you need and cut as show below. After cutting it is recommended to use an anticorrosive paint.

EXAMPLE OF CUTTING TUBE



EXAMPLE OF ASSEMBLED TUBE

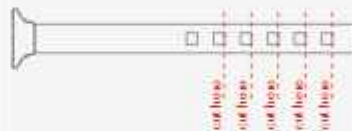

- Screw TE M12x50 ZNB
4 pcs
- Washer M12 ZNB
8 pcs
- Self-blocking nut M12
4 pcs

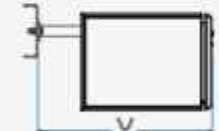

For Toolbox code	Tube diameter	A mm	Fast Mounting Tube code	Y	Y
				TUBE - A	TUBE - B
cod. E2 152/153 cod. E4 152/153 cod. E6 152/153 cod. E8 152/153 I. 500 x H. 350 x D. 400	ø 30	414	E2 951 02 - Short Tube	Y1: 434 mm	Y1: 614 mm
			E2 951 04 - Medium Tube	Y1: 544 mm	Y2: 586 mm
			E2 951 06 - Long tube	Y1: 654 mm	Y3: 558 mm
			E2 951 08 - Customized Tube	Y: TUBE - B	Y4: 530 mm
cod. E2 202/203 cod. E4 202/203 cod. E6 202/203 cod. E8 202/203 I. 600 x H. 400 x D. 500	ø 42	508	E2 961 02 - Short Tube	Y1: 582 mm	Y5: 502 mm
			E2 961 04 - Medium Tube	Y1: 702 mm	Y6: 474 mm
			E2 961 06 - Long tube	Y1: 822 mm	Y7: 798 mm
			E2 961 08 - Customized Tube	Y: TUBE - B	Y8: 770 mm
cod. E2 252/253 cod. E4 252/253 cod. E6 252/253 cod. E8 252/253 I. 800 x H. 500 x D. 500	ø 42	708	E2 961 02 - Short Tube	Y1: 582 mm	Y9: 742 mm
			E2 961 04 - Medium Tube	Y1: 702 mm	Y10: 714 mm
			E2 961 06 - Long tube	Y1: 822 mm	Y11: 686 mm
			E2 961 08 - Customized Tube	Y: TUBE - B	Y12: 658 mm
cod. E2 302/303 cod. E4 302/303 cod. E6 302/303 cod. E8 302/303 I. 1000 x H. 500 x D. 500	ø 42	908	E2 961 02 - Short Tube	Y1: 582 mm	Y13: 630 mm
			E2 961 04 - Medium Tube	Y1: 702 mm	Y14: 602 mm
			E2 961 06 - Long tube	Y1: 822 mm	Y15: 574 mm
			E2 961 08 - Customized Tube	Y: TUBE - B	Y16: 546 mm

Packaging & Shipment_Adj. Fast Mounting



Shipment_Adj. Fast Mounting for Toolboxes E2 152/153 - E4 152/153 - E6 152/153 - E8 152/153



toolboxes	20 BOX			40 FT HC			TRUCK		
	pallet size mm.			pallet size mm.			pallet size mm.		
Mounting Hit tube code	L	H	D	L	H	D	L	H	D
cod. E2 951 02	1100	725	1400	1100	895	1400	1100	980	1400
cod. E2 951 04	1100	895	1400	1100	1065	1400	1100	1235	1400
cod. E2 951 06	1100	980	1400	1100	1150	1400	1100	1320	1400
cod. E2 951 08	1100	980	1400	1100	1150	1400	1100	1320	1400

Shipment_Adj. Fast Mounting for Toolboxes E2 202/203 - E4 202/203 - E6 202/203 - E8 202/203



toolboxes	20 BOX			40 FT HC			TRUCK		
	pallet size mm.			pallet size mm.			pallet size mm.		
Mounting Hit tube code	L	H	D	L	H	D	L	H	D
cod. E2 961 02	1100	810	1250	1100	895	1250	1100	1320	1250
cod. E2 961 04	1100	980	1250	1100	1150	1250	1100	1660	1250
cod. E2 961 06	1100	1150	1250	1100	1320	1250	1100	2000	1250
cod. E2 961 08	1100	1150	1250	1100	1320	1250	1100	2000	1250

Shipment_Adj. Fast Mounting for Toolboxes E2 252/253 - E4 252/253 - E6 252/253 - E8 252/253



toolboxes	20 BOX			40 FT HC			TRUCK		
	pallet size mm.			pallet size mm.			pallet size mm.		
Mounting Hit tube code	L	H	D	L	H	D	L	H	D
cod. E2 961 02	1100	810	840	1100	810	840	1100	980	840
cod. E2 961 04	1100	1150	840	1100	1150	840	1100	1320	840
cod. E2 961 06	1100	1150	840	1100	1150	840	1100	1320	840
cod. E2 961 08	1100	1150	840	1100	1150	840	1100	1320	840

Shipment_Adj. Fast Mounting for Toolboxes E2 302/303 - E4 302/303 - E6 302/303 - E8 302/303



toolboxes	20 BOX			40 FT HC			TRUCK		
	pallet size mm.			pallet size mm.			pallet size mm.		
Mounting Hit tube code	L	H	D	L	H	D	L	H	D
cod. E2 961 02	1060	1150	1060	1060	1820	1060	1060	1405	1060
cod. E2 961 04	1060	1405	1060	1060	1490	1060	1060	1660	1060
cod. E2 961 06	1060	1660	1060	1060	1830	1060	1060	2000	1060
cod. E2 961 08	1060	1660	1060	1060	1830	1060	1060	2000	1060



Lock System Kit

Suitable for the versions

Easy

Basic

Easy Plus

Premium



Lock System Kit
2 handles

Code
cod. E0 990 51

Rubber Clamp

Suitable for the versions

Easy

Basic

Easy Plus

Premium



Rubber Clamp Size
L 206 x H 46

Code
cod. E0 990 52

Ring-Holder

Suitable for the versions

Easy

Basic



Ring-Holder
diameter of 160 mm.

Code
cod. E0 990 53

Fast Mounting Kit

Suitable for the versions

Easy Plus

Premium



Fast Mounting Kit
- Ring-Holder*
- Rubber Clamp
- Brackets

Code
cod. E0 990 50

*diameter of 160 mm.

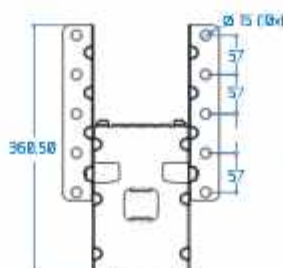



Pull-out Drawer Kit

Suitable for the versions

Plus

Premium

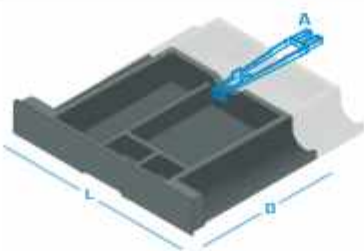
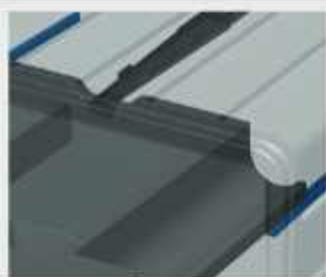

	Drawer Size	Drawer Code
For toolbox length 500*	L 439 x D 330	cod. E0 998 00
For toolbox length 600	L 535 x D 390	cod. E0 998 02
For toolbox length 800	L 729 x D 388	cod. E0 998 06
For toolbox length 1000	L 922 x D 388	cod. E0 998 08

* for the toolbox cod. E0 142 - pull-out drawer not available

A - Drawer Stop included in the kit

Lock System Kit

Suitable for the versions

Easy

Basic

Plus

Premium



Evoplex

	Lock Type	Lock Code
For toolboxes E0	Evoplex	cod. E0 996 02

Cylinder Lock

Suitable for the versions

Easy

Basic

Plus

Premium



Universal Keys

keys number 0010

Cylinder with universal keys	cod. E0 996 00
Cylinder with keys number 0010	cod. E0 996 01

Stop Lid Chain

Suitable for the versions

Easy

Basic

Plus

Premium



	Chain Size	Chain Code
For toolbox length 500	Chain Links: 21	cod. E0 996 05
For toolbox length 600	Chain Links: 26	cod. E0 996 07
For toolbox length 800	Chain Links: 38	cod. E0 996 08
For toolbox length 1000	Chain Links: 38	cod. E0 996 08

Lid Configurations

Suitable for the versions

Easy

Basic

Plus

Premium



Adhesive BAWER Logo



Adhesive Logo Slot

Adhesive Customer Logo **LOGO**

*min. 250 pcs



BAWER Logo



Serigraphy Logo

in the colour required

*min. 40 pcs



Customer Logo

Monochrome Two-Tones

*min. 2500 pcs

Pull-out Drawer Kit

Suitable for the versions

Plus

Smart

Premium

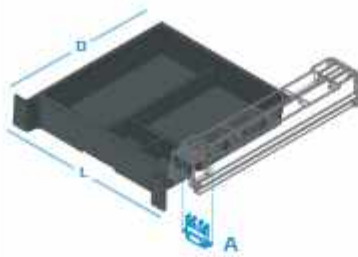
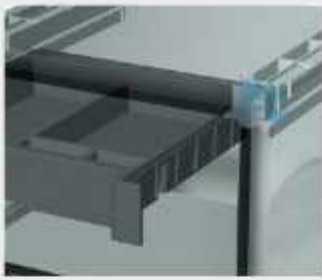

	Drawer Size	Drawer Code
For toolboxes length 500	L 410 x D 370	cod. E2 998 00
For toolboxes length 600	L 510 x D 468	cod. E2 998 02
For toolboxes length 800	L 707 x D 471	cod. E2 998 06
For toolboxes length 1000	L 906 x D 472	cod. E2 998 08

A - Drawer Stop included in the kit

Lock system Kit

Suitable for the versions

Basic

Plus

Smart

Premium



Evoplex

Evoinox

	Lock Type	Lock Code
For toolboxes E2	Evoplex	cod. E2 996 01
For toolboxes E4 E5 E8	Evoinox	cod. E2 996 02

Cylinder Lock

Suitable for the versions

Basic

Plus

Smart

Premium



Universal Keys

keys number 0010

Cylinder with universal keys	cod. V99 92
Cylinder with keys number 0010	cod. TA 99 92 00

Internal Mat

Suitable for the versions

Basic

Plus

Smart

Premium

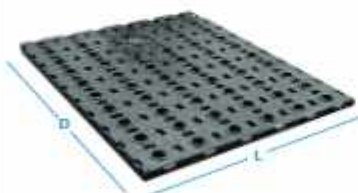
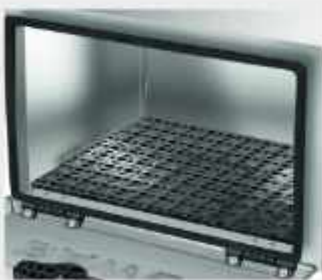

Plastic Mat

	Mat size	Mat Code
For toolboxes length 500	L 500 x D 400	cod. V98 15
For toolboxes length 600	L 600 x D 500	cod. V98 20
For toolboxes length 800	L 800 x D 500	cod. V98 25
For toolboxes length 1000	L 1000 x D 500	cod. V98 30

Aerator

Suitable for the versions

Basic

Plus

Smart

Premium



Air Ventilation Control

Air Ventilation Control	Aerator Size Ø 100 mm.	Aerator Code cod. V99 97
-------------------------	---------------------------	-----------------------------

Gas Spring Hit

Suitable for the versions

Basic

Plus

Smart

Premium



brackets*

	Gas Spring Size	Gas Spring Code
For toolbox length 500	L: 200 mm.	cod. E2 996 04
For toolbox length 600	L: 225 mm.	cod. E2 996 05
For toolbox length 800 1000	L: 318 mm.	cod. E2 996 06

*Steel brackets included in the hit

Fast Mounting

Suitable for the versions

Smart

Premium

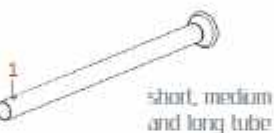

Stainless Steel Tube

short, medium
and long tubecustomized tube
with multi holes

For toolbox length 500	Short Tube	Medium Tube	Long Tube	Customized Tube
	cod. E6 950 02	cod. E6 950 04	cod. E6 950 06	cod. E6 950 08

For toolbox length 600 800 1000	Short Tube	Medium Tube	Long Tube	Customized Tube
	cod. E6 960 02	cod. E6 960 04	cod. E6 960 06	cod. E6 960 08



For Toolbox length 500					For Toolbox length 600/800/1000				
V Tube	Short Tube	Medium Tube	Long Tube	Customized Tube	V Tube	Short Tube	Medium Tube	Long Tube	Customized Tube
Y1	424 mm.	534 mm.	644 mm.	604 mm.	Y1	582 mm.	702 mm.	822 mm.	798 mm.
Y2	-	-	-	576 mm.	Y2	-	-	-	770 mm.
Y3	-	-	-	548 mm.	Y3	-	-	-	742 mm.
Y4	-	-	-	520 mm.	Y4	-	-	-	714 mm.
Y5	-	-	-	492 mm.	Y5	-	-	-	686 mm.
Y6	-	-	-	464 mm.	Y6	-	-	-	658 mm.
					Y7	-	-	-	630 mm.
					Y8	-	-	-	602 mm.
					Y9	-	-	-	574 mm.
					Y10	-	-	-	546 mm.

Adj. Fast Mounting

Suitable for the versions

Smart

Premium

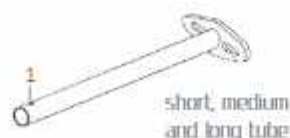
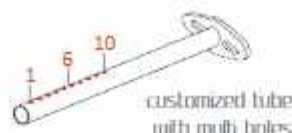

Stainless Steel Tube

Suitable for chassis with pre-drilled holes
P: from 4R to 6R mmshort, medium
and long tubecustomized tube
with multi holes

For toolbox length 500	Short Tube	Medium Tube	Long Tube	Customized Tube
	cod. E6 951 02	cod. E6 951 04	cod. E6 951 06	cod. E6 951 08

For toolbox length 600 800 1000	Short Tube	Medium Tube	Long Tube	Customized Tube
	cod. E6 961 02	cod. E6 961 04	cod. E6 961 06	cod. E6 961 08



For Toolbox length 500					For Toolbox length 600/800/1000				
V Tube	Short Tube	Medium Tube	Long Tube	Customized Tube	V Tube	Short Tube	Medium Tube	Long Tube	Customized Tube
Y1	424 mm.	534 mm.	644 mm.	604 mm.	Y1	582 mm.	702 mm.	822 mm.	798 mm.
Y2	-	-	-	576 mm.	Y2	-	-	-	770 mm.
Y3	-	-	-	548 mm.	Y3	-	-	-	742 mm.
Y4	-	-	-	520 mm.	Y4	-	-	-	714 mm.
Y5	-	-	-	492 mm.	Y5	-	-	-	686 mm.
Y6	-	-	-	464 mm.	Y6	-	-	-	658 mm.
					Y7	-	-	-	630 mm.
					Y8	-	-	-	602 mm.
					Y9	-	-	-	574 mm.
					Y10	-	-	-	546 mm.

Copyright

All rights are reserved.
Reproduction in whole or in part of this artwork is forbidden, in any form and by any means, without authorization of the copyright holder.

The company reserves the right to make any change or modification it deems appropriate, even without any advance notice, in order to improve the quality and the performance of its products.

The company declines all responsibilities for possible printing errors, omissions, incorrect indications and descriptions or other errors incurred during the creation of the catalogue.

BAWER S.p.A.

Z.I. Jesce - 75100 Matera - Italy
tel. +39 0835 24 59 11
fax +39 0835 24 59 35
email | info@bawer.it
website | www.bawer.it

follow us:





THE TOOLBOX R**e**VOLUTION

