

# RAILIFT™ SERIES

## The DMD Series



### DMD GENERATION 2.0 SPECIFICATIONS

**The DMD is a medium-duty, fully hydraulic direct lift that utilizes a twin cylinder design to ensure efficient performance**

- The DMD Generation 2.0 features Aluminum columns paired with galvanized steel runners
- The DMD utilizes a unique twin cylinder lifting design that eliminates the maintenance costs associated with other chain or cable equipped liftgates
- The pump and motor assembly is housed within the liftgate's main structural enclosure
- The DMD features fully sealed switches and harnesses to protect them against corrosion
- All aluminum platforms
- MAX GRIP® and Cycle Counter standard

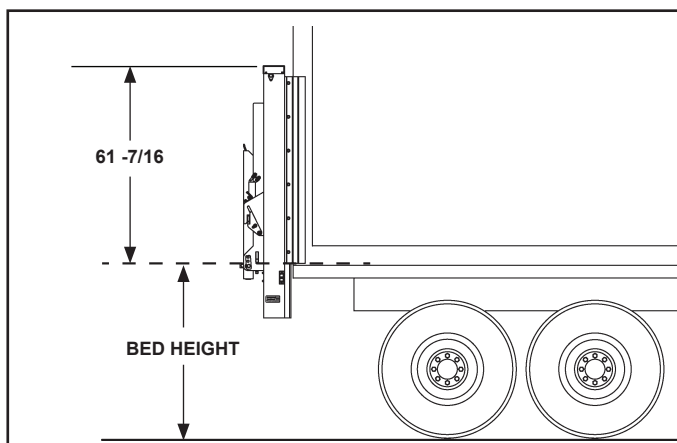

Load-Over Bedheights

Two Piece Platform Plus 6" Ramp	Min Bed Height for loading over	Two Piece Platform Plus 12" Ramp	Min Bed Height for loading over
48" (30+18) + 6" fixed ramp	32"	42" (30+12) +12" fixed ramp	32"
54" (33+21) + 6" fixed ramp	35"	48" (33+15) +12" fixed ramp	35"
60" (36+24) + 6" fixed ramp	38"	54" (36+18) +12" fixed ramp	38"
66" (39+27) + 6" fixed ramp	41"	60" (39+21) +12" fixed ramp	41"
72" (42+30) + 6" fixed ramp	44"	66" (42+24) +12" fixed ramp	44"

NOTE: Please review DMD liftgate installation manual for full vehicle and or body requirements to ensure proper fitment.

MODEL CAPACITY	BODY WIDTH	PLATFORM SIZE*	TOTAL WEIGHT	BED HEIGHT
DMD 18 1,800 LBS	96"	<b>One-piece platforms:</b> 36", 42", 48" + 6" or 12"**** Fixed Ramp with optional Single or Dual Cart Stops or 9" Aluminum Retention Ramp or 39", 45" + 9" Fixed Ramp with Single or Dual Cart Stops	635 to 730 Lbs.	30" - 54" *****
DMD 22 2,200 LBS.		<b>Two-piece platforms:</b> 48" (30+18), 54" (33+21), 60" (36+24), 66" (39+27), 72" (42+30) + 6" fixed Ramp with optional Dual or Single Cart Stops or 42" (30+12), 48" (33+15), 54" (36+18), 60" (39+21), 66" (42+24) +12" fixed ramp with optional Dual or Single Cart Stops		
DMD 33 3,300 LBS.				
DMD 18** 1,800 LBS Power Closer	102"	<b>One-piece platforms:</b> 48", 54", 60", 66", 72" +12" fixed ramp with optional Single or Dual Cart Stops or 9" Aluminum Retention Ramp**** or 51", 57", 63", 69", 75" +9" Fixed Ramp with Single or Dual Cart Stops	675 to 745 Lbs.	
DMD 22** 2,200 LBS. Power Closer		<b>Two-piece platforms:</b> 48" (30+18), 54" (33+21), 60" (36+24), 66" (39+27), 72" (42+30) + 6" fixed ramp with optional Single or Dual Cart Stops or 42" (30+12), 48" (33+15), 54" (36+18), 60" (39+21), 66" (42+24) +12" fixed ramp with optional Dual or Single Cart Stops		
DMD 33** 3,300 LBS. Power Closer				

\* Platform width for 96" body: 90"; 102" body: 96"

\*\* Units with hydraulic power closer have 1.25" less unobstructed opening.

\*\*\* 12" Fixed ramp only available on 36" and 42" platforms

\*\*\*\* Not on 48"

\*\*\*\*\* Note that maximum bed height of above bed models is being reduced by the amount of above floor travel



# RAILIFT™ SERIES

## The DMD Series

# MAXON®

### Optional Equipment

- Domestic or Foreign Chassis Light Set Ups
- Cab Cut Off Switch
- Handheld Control
- Additional Street Side Control
- Backup Alarm Installation Kit
- Platform Hydraulic Power Closure\*
- Above Bed Travel \*\*

\* large, single-piece platforms come with power closure standard; on other configurations power closure is optional

\*\* Note that maximum bed height of above bed models is being reduced by the amount of above floor travel

### Loadable Platform Space with Cart Stops Deployed

NEW DMD ONE PC PLATFORM WITH SINGLE OR DUAL CART STOP & 6" FIXED RAMP

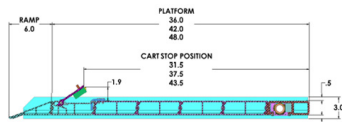

NEW DMD ONE PC PLATFORM WITH SINGLE OR DUAL CART STOP ON 9" RAMP

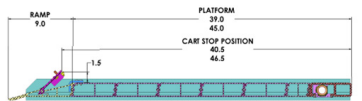

NEW DMD ONE PC PLATFORM WITH SINGLE OR DUAL CART STOP ON 12" RAMP

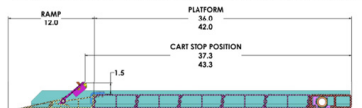

NEW DMD TWO PC PLATFORM WITH SINGLE OR DUAL CART STOP ON FLIPOVER WITH 6" FIXED RAMP

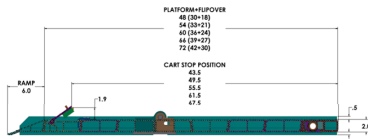

NEW DMD TWO PC PLATFORM WITH SINGLE OR DUAL CART STOP ON 12" RAMP

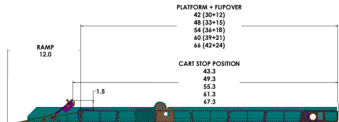

Distributed by:

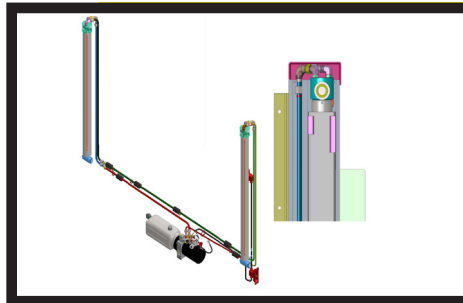

### Effective Hydraulic System

Two direct-acting lifting cylinders. The master cylinder drives the second cylinder. The ultimate goal was to develop the most reliable medium-duty gate with the least need for maintenance



### Aluminum Columns / Galvanized Runners

The DMD 2.0 features extruded Aluminum columns and galvanized steel runners. This combination results in overall weight reduction, enhanced corrosion resistance, and increased performance.



### Pump and Motor Housing Options

The DMD's main pump housing is available in four different light configurations and also features a license plate holder and an optional back-up alarm install kit



### Corrosion Resistant Electrical System

The DMD features fully sealed switches and harnesses to protect them against corrosion



### Aluminum Platform w/ Cart Stop Option

The DMD features an all-Aluminum platform with optional single - or dual cart stops

M198-1121



Maxon Lift Corp. 11921 Slauson Ave., Santa Fe Springs, CA 90670  
800.227.4116 Fax 888.771.7713, www.maxonlift.com