



TRUCK TOOL BOXES



NEW Redesigned Crossover Boxes -
Page 63

NOTHING WORKS LIKE A DOGG[®]

Our History



1946
Buyers Products Company founded by Sam Ruven and Bessie Kleinman as a distributor of driveline components.

Tracom

1992
Buyers acquired Trailer Components Manufacturing (Tracom) for CNC precision machining and tooling, as well as state-of-the-art welding.

Buyers
PRODUCTS COMPANY

2002
Buyers moved its corporate headquarters to a brand new 235,000 sq. ft. state-of-the-art office and distribution center.

SnowDog
Buyers

2007
Buyers began manufacturing the SnowDog stainless steel snowplow at our Mentor, Ohio facility.

Buyers
PRODUCTS COMPANY

2013
Buyers acquired an additional 500,000 sq.ft. manufacturing facility in Mentor, Ohio allowing for expansion of our aluminum and stainless steel manufacturing.

SaltDog
Buyers

**ALL YOUR WORK
TRUCK PRODUCTS
ALL THE TIME.**

2017
Buyers launches new website with business partner portal, to make online ordering and account maintenance easy for customers.

Buyers

Buyers continued to grow its product offerings and build valued relationships with customers and suppliers. Increased demand for products led to the pursuit of supply chain manufacturing solutions.

PROGRESSIVE
POWDER COATING, INC.

1995
Buyers acquired Progressive Powder Coating. Our Nordson automatic powder application booth is used to powder coat our Buyers toolboxes and other truck and trailer accessories.

Romotech
Rotational Molding Technologies, Inc.

2004
Buyers acquired Romotech in New Paris, Indiana. Our Ferry Industries Rotospeed molding machines are used to manufacture our poly salt spreaders.

Boomerang
RUBBER, INC.

2009
Buyers began our operations at Boomerang Rubber, in Botkins, Ohio manufacturing mudflaps, wheel chocks and other rubber truck and trailer accessories.

Buyers
PRODUCTS COMPANY

2016
Buyers establishes a 22,000 sq ft Engineering Tech Center in Mentor, Ohio. It's multi-use lab, design, training and prototyping space is dedicated to the research and development of innovative product.

Our Corporate Family of Companies



Founded in 1946, Buyers Products is a fully integrated manufacturer and a leader in the truck equipment industry. Our engineering, manufacturing and assembly operations take place in the USA, under the Buyers family of companies. **Buyers Products' mission is to improve our Customers' profitability and productivity while enhancing the quality of our products and services.**





NEW PRODUCTS:

UNDERBODY 4-29

XD Steel.....	6-7
Steel	8-17
XD Aluminum.....	18-21
Aluminum	22-27
Polymer	27
Mounting Brackets.....	28-29

TOPSIDER 30-39

Steel	32-33
XD Steel.....	33
Aluminum	34-39

BACKPACK..... 40-55

Four Door Offset.....	42-43
Four Door Flat	44-45
Two Door Offset	46-47
Two Door Flat	48-49
L-Pack.....	50-51
Underbody Boxes	52-53
Accessories.....	54-55

IN-BED STORAGE..... 56-69

Crossover	58-60
Wheel Well.....	61
Lo-Sider.....	62-63
Storage Chests	64-67
Slide Out Truck Bed Boxes	68-69

TRAILER TONGUE 70-71

CLASS 8 BOXES 72-75

PARTS & ACCESSORIES..... 76-78

DISPLAYS..... 79

REPLACEMENT PARTS 80-81

INDEX 82-83

XD ALUMINUM UNDERBODY

NEW Now available in black and white powder-coated finish

pg. 20



1706965

NEW COMPLETELY REDESIGNED CROSSOVER SERIES

pg. 63



1739410

NEW WIDOPEN™ STEP BOXES

pg. 77



1705281



UNDER



UNDERBODY

XD Steel Underbodies

Buyers' Toughest Line of Boxes Built for Heavy Duty Commercial Use



XD Steel Features



Cross-broke door for added durability



Detachable 3/16 in. door chains



Greasable bullet hinges



Built-in rain gutter

- 12 gauge steel box and cross-broke door
- Patent pending removable door design
- Automotive D-bulb seal
- Greasable bullet hinges with 1/2" stainless steel pins
- Built-in rain gutter
- Detachable 3/16" door chains
- Locking die cast T-handle compression latch



Black, Single Latch



Part No.	Height	Depth	Width	# Latches per Door	Wt. (lb)	Cat.
1742300	18	18	24	1	80	530 (Y)
1742303	18	18	30	1	91	530 (Y)
1742305	18	18	36	1	104	530 (Y)
1742310	18	18	48	1	127	530 (Y)
1744300	24	24	24	1	90	530 (Y)
1744303	24	24	30	1	115	530 (Y)
1744305	24	24	36	1	132	530 (Y)

Black, Double Door

Works great as Topsider on flatbeds and service bodies.



Part No.	Height	Depth	Width	# Latches per Door	Wt. (lb)	Cat.
1742315†	18	18	60	1	175	530 (Y)
1742325†	18	18	72	1	202	530 (Y)
1742335†	18	18	90	1	228	530 (Y)
1742336†	18	18	96	2	250	530 (Y)

†Boxes can be used as topsiders and underbodies

Steel Underbodies



14 gauge powder-coated steel box with 12 gauge steel door

Replaceable gasket sealing system

Bolt-on, stainless steel continuous hidden hinge

Aircraft grade door cables

Drop-down recessed door

1702305

Steel Features



Bolt-on, stainless steel continuous hidden hinge



Replaceable gasket sealing system



Aircraft grade door cables

T-HANDLE LATCH

- 14 gauge powder-coated steel box with 12 gauge steel door
- Drop-down recessed door
- Locking stainless steel T-handle latches
- Bolt-on, stainless steel continuous hidden hinge
- Replaceable gasket sealing system
- Aircraft grade door cables
- Reinforced door backbone on boxes 48" and wider
- Door opening: flat surface mount (90°) or underbody mount (180°)

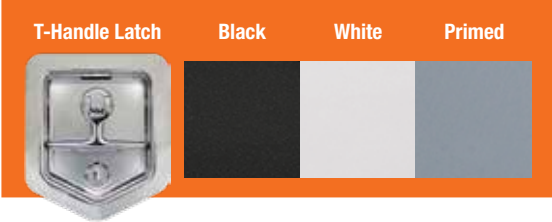

Black, Single Latch



Part No.	Height	Depth	Width	# Latches per Door	Wt. (lb)	Cat.
1703349	14	12	18	1	37	530 (Y)
1703350	14	12	24	1	40	530 (Y)
1703353	14	12	30	1	49	530 (Y)
1703300	14	16	24	1	56	530 (Y)
1703303	14	16	30	1	65	530 (Y)
1703305	14	16	36	1	74	530 (Y)
1703310	15	10	15	1	28	530 (Y)
1703312	15	10	24	1	39	530 (Y)
1703320	15	13	15	1	32	530 (Y)
1703322	15	13	24	1	45	530 (Y)
1703324	15	13	30	1	53	530 (Y)
1703326	15	13	36	1	61	530 (Y)
1703330	16	14	18	1	50	530 (Y)
1702295	18	18	18	1	47	530 (Y)
1702300	18	18	24	1	67	530 (Y)
1702303	18	18	30	1	80	530 (Y)
1702305	18	18	36	1	92	530 (Y)
1704300	24	24	24	1	87	530 (Y)
1704303	24	24	30	1	100	530 (Y)
1704305	24	24	36	1	116	530 (Y)

Black, Dual Latch



Part No.	Height	Depth	Width	# Latches per Door	Wt. (lb)	Cat.
1703328*	15	13	48	2	83	530 (Y)
1702310	18	18	48	2	118	530 (Y)
1702315	18	18	60	2	143	530 (Y)
1702317	18	18	66	2	186	530 (Y)
1708310	18	24	48	2	133	530 (Y)
1704310	24	24	48	2	145	530 (Y)
1704315	24	24	60	2	175	530 (Y)

Black, Double Door



Part No.	Height	Depth	Width	# Latches per Door	Wt. (lb)	Cat.
1702325†	18	18	72	1	156	530 (Y)

†Boxes can be used as topsiders and underbodies

Steel Underbody

White, Single Latch



Part No.	Height	Depth	Width	# Latches per Door	Wt. (lb)	Cat.
1703400	14	16	24	1	56	530 (Y)
1703403	14	16	30	1	65	530 (Y)
1703405	14	16	36	1	71	530 (Y)
1703495	18	18	18	1	47	530 (Y)
1702400	18	18	24	1	67	530 (Y)
1702403	18	18	30	1	80	530 (Y)
1702405	18	18	36	1	92	530 (Y)
1704400	24	24	24	1	87	530 (Y)
1704403	24	24	30	1	100	530 (Y)
1704405	24	24	36	1	116	530 (Y)

White, Dual Latch



Part No.	Height	Depth	Width	# Latches per Door	Wt. (lb)	Cat.
1702410	18	18	48	2	118	530 (Y)
1702415	18	18	60	2	143	530 (Y)
1702417	18	18	66	2	186	530 (Y)
1708410	18	24	48	2	133	530 (Y)
1704410	24	24	48	2	145	530 (Y)
1704415	24	24	60	2	175	530 (Y)

Primed, Single Latch



Part No.	Height	Depth	Width	# Latches per Door	Wt. (lb)	Cat.
1703900	14	16	24	1	56	530 (Y)
1702900	18	18	24	1	67	530 (Y)
1702905	18	18	36	1	92	530 (Y)

Primed, Dual Latch



Part No.	Height	Depth	Width	# Latches per Door	Wt. (lb)	Cat.
1702910	18	18	48	2	118	530 (Y)

T-HANDLE LATCH WITH SHELF

- 14 gauge steel box with 12 gauge steel door
- 14 gauge steel shelf welded at mid height, 12-3/4" deep with 1" front lip
- Locking stainless steel T-handle latches
- Aircraft grade door cables
- Replaceable gasket sealing system

Black



Part No.	Height	Depth	Width	# Latches per Door	Wt. (lb)	Cat.
1703304	14	16	30	1	72	530 (Y)

White



Part No.	Height	Depth	Width	# Latches per Door	Wt. (lb)	Cat.
1703404	14	16	30	1	72	530 (Y)
1702406†	18	18	36	1	82	530 (Y)
1702411†	18	18	48	1	106	530 (Y)

†These have 3-Point Compression Latches (see page 13)

T-HANDLE LATCH WITH SLANTED BACK

- Angled top allows room for fuel fill hoses on single rear wheel flat beds
- Locking stainless steel T-handle latches
- Door opening: flat surface mount (90°) or underbody mount (180°)
- Drop-down recessed door
- Replaceable gasket sealing system

Black



Part No.	Height	Depth	Width	# Latches per Door	Wt. (lb)	Cat.
1703351	14	12	18	1	40	530 (Y)
1703352	14	12	24	1	47	530 (Y)
1703355	14	12	30	1	49	530 (Y)



See pg. 28-29 for Underbody Mounting Brackets

Steel Underbody

PADDLE LATCH

- 14 gauge powder-coated steel box with 12 gauge steel door
- Drop-down recessed door
- Locking stainless steel paddle latch
- Continuous bolt-on hidden hinge
- Replaceable gasket sealing system
- Aircraft grade door cables
- Reinforced door backbone on boxes 48" and wider
- Door opening: flat surface mount (90°) or underbody mount (180°)



Black, Single Latch



Part No.	Height	Depth	Width	# Latches per Door	Wt. (lb)	Cat.
1703150	14	12	24	1	48	530 (Y)
1703100	14	16	24	1	56	530 (Y)
1703103	14	16	30	1	65	530 (Y)
1702100	18	18	24	1	67	530 (Y)
1702103	18	18	30	1	80	530 (Y)
1702105	18	18	36	1	92	530 (Y)

Black, Dual Latch



Part No.	Height	Depth	Width	# Latches per Door	Wt. (lb)	Cat.
1702110	18	18	48	2	118	530 (Y)
1702115	18	18	60	2	143	530 (Y)

White, Single Latch



Part No.	Height	Depth	Width	# Latches per Door	Wt. (lb)	Cat.
1703203	14	16	30	1	65	530 (Y)
1703205	14	16	36	1	74	530 (Y)
1702200	18	18	24	1	67	530 (Y)
1702203	18	18	30	1	80	530 (Y)
1702205	18	18	36	1	92	530 (Y)

White, Dual Latch



Part No.	Height	Depth	Width	# Latches per Door	Wt. (lb)	Cat.
1702210	18	18	48	2	118	530 (Y)
1702215	18	18	60	2	143	530 (Y)

3-POINT COMPRESSION LATCH

- 14 gauge powder-coated steel box with 12 gauge steel door
- Drop-down recessed door
- Die-cast T-handle compression latch with 3-point locking system
- Bolt-on continuous hidden hinge
- Replaceable gasket sealing system
- Aircraft grade door cables
- Reinforced door backbone on boxes 48" and wider
- Door opening: flat surface mount (90°) or underbody mount (180°)

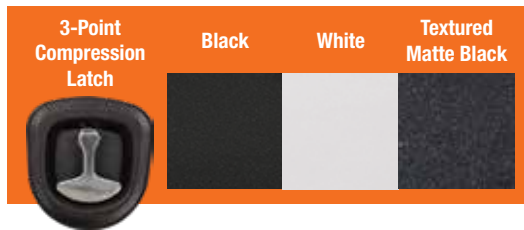

Black



Part No.	Height	Depth	Width	# Latches per Door	Wt. (lb)	Cat.
1732300	18	18	24	1	59	530 (Y)
1732303	18	18	30	1	70	530 (Y)
1732305	18	18	36	1	83	530 (Y)
1732310	18	18	48	1	118	530 (Y)
1732315*	18	18	60	1	143	530 (Y)
1734300	24	24	24	1	84	530 (Y)
1734303	24	24	30	1	95	530 (Y)
1734305	24	24	36	1	110	530 (Y)

White



Part No.	Height	Depth	Width	# Latches per Door	Wt. (lb)	Cat.
1732400	18	18	24	1	59	530 (Y)
1732403	18	18	30	1	70	530 (Y)
1732405	18	18	36	1	83	530 (Y)
1734400	24	24	24	1	84	530 (Y)
1734403	24	24	30	1	95	530 (Y)
1734405	24	24	36	1	110	530 (Y)
1702406†	18	18	36	1	82	530 (Y)
1702411†	18	18	48	1	106	530 (Y)

†Includes shelf (see page 11)

Textured Matte Black



Part No.	Height	Depth	Width	# Latches per Door	Wt. (lb)	Cat.
1732500	18	18	24	1	59	530 (Y)
1732503	18	18	30	1	70	530 (Y)
1732505	18	18	36	1	83	530 (Y)
1732510	18	18	48	1	118	530 (Y)
1734500	24	24	24	1	84	530 (Y)
1734503	24	24	30	1	95	530 (Y)
1734505	24	24	36	1	110	530 (Y)

Steel Underbody

POLISHED STAINLESS STEEL DOOR WITH COMPRESSION LATCH

- 14 gauge steel or stainless box with 12 gauge steel door or polished 12 gauge stainless steel door
- Drop-down recessed door
- Locking die-cast T-handle compression latch
- Continuous hidden hinge
- Replaceable gasket sealing system
- Aircraft grade door cables
- Reinforced door backbone on boxes 48" and wider
- Door opening: flat surface mount (90°) or underbody mount (180°)



Black Box, Single Latch



Part No.	Height	Depth	Width	# Latches per Door	Wt. (lb)	Cat.
1703700	14	16	24	1	55	530 (Y)
1703703	14	16	30	1	64	530 (Y)
1703705	14	16	36	1	71	530 (Y)
1702700	18	18	24	1	72	530 (Y)
1702703	18	18	30	1	81	530 (Y)
1702705	18	18	36	1	101	530 (Y)
1704705	24	24	36	1	132	530 (Y)

Black Box, Dual Latch



Part No.	Height	Depth	Width	# Latches per Door	Wt. (lb)	Cat.
1702710	18	18	48	2	110	530 (Y)
1702715	18	18	60	2	132	530 (Y)
1704710	24	24	48	2	169	530 (Y)
1704715	24	24	60	2	227	530 (Y)

Black Box, Double Door



Part No.	Height	Depth	Width	# Latches per Door	Wt. (lb)	Cat.
1702725	18	18	72	1	156	530 (Y)

Stainless Box, Single Latch



Part No.	Height	Depth	Width	# Latches per Door	Wt. (lb)	Cat.
1702595	18	18	18	1	51.5	530 (Y)
1702600	18	18	24	1	61.5	530 (Y)
1702603	18	18	30	1	81	530 (Y)
1702605	18	18	36	1	85	530 (Y)
1704600*	24	24	24	1	87	530 (Y)
1704603*	24	24	30	1	100	530 (Y)
1704605*	24	24	36	1	116	530 (Y)

Stainless Box, Dual Latch



Part No.	Height	Depth	Width	# Latches per Door	Wt. (lb)	Cat.
1702610	18	18	48	2	110	530 (Y)
1704610*	24	24	48	2	145	530 (Y)
1704615*	24	24	60	2	175	530 (Y)



Steel Underbody

MIRROR FINISH STAINLESS STEEL DOOR WITH COMPRESSION LATCH

- 16 gauge high polish steel box and door
- Drop-down external door
- Locking die-cast T-handle compression latch
- Continuous hidden hinge
- Replaceable door cables
- Built-in rain gutter with automotive bulb seal



Single Latch



Part No.	Height	Depth	Width	# Latches per Door	Wt. (lb)	Cat.
1702650	18	18	24	1	48	530 (N)
1702653	18	18	30	1	57	530 (N)
1702655	18	18	36	1	65	530 (N)

Dual Latch



Part No.	Height	Depth	Width	# Latches per Door	Wt. (lb)	Cat.
1702660	18	18	48	2	80	530 (N)



DIAMOND TREAD ALUMINUM DOOR WITH COMPRESSION LATCH

- 14 gauge steel box with .100" thick diamond tread door
- Drop-down recessed door
- Locking die-cast T-handle compression latch
- Bolt-on continuous hidden hinge
- Replaceable gasket sealing system
- Aircraft grade door cables
- Door opening: flat surface mount (90°) or underbody mount (180°)
- Reinforced door backbone on boxes 48" and wider



Black, Single Latch



Part No.	Height	Depth	Width	# Latches per Door	Wt. (lb)	Cat.
1702500	18	18	24	1	61	530 (Y)
1702503	18	18	30	1	72	530 (Y)
1702505	18	18	36	1	82	530 (Y)

Black, Dual Latch



Part No.	Height	Depth	Width	# Latches per Door	Wt. (lb)	Cat.
1702510	18	18	48	2	104	530 (Y)



See pg. 28-29 for Underbody Mounting Brackets

XD Aluminum Underbodies

Buyers' Toughest Line of Boxes Built for Heavy Duty Commercial Use



XD Aluminum Features



Die-cast T-handle compression latch with 3-point locking system



Rain gutter for added protection



Rigid extruded box frame and automotive bulb seal



Unobstructed box opening

SMOOTH ALUMINUM BARN DOOR WITH 3-POINT COMPRESSION LATCH

- .125" thick smooth aluminum with rigid extruded box frame
- Die-cast T-handle compression latch with 3-point locking system
- Stainless steel bolt-on continuous hinge with oversized 1/4" pin
- Built-in rain gutter with automotive bulb seal
- Unobstructed box opening with no center post

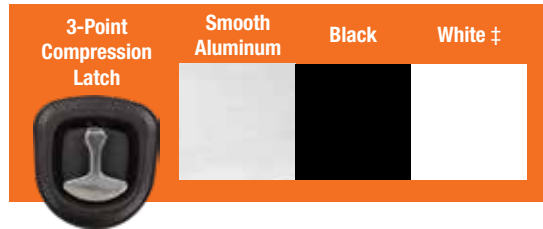

Smooth Aluminum



Part No.	Height	Depth	Width	# Latches per Door	Wt. (lb)	Cat.
1705405	18	18	36	1	51	530 (Y)
1705410	18	18	48	1	62	530 (Y)
1705415	18	18	60	1	73	530 (Y)
1705420	18	24	36	1	58	530 (Y)
1705425	18	24	48	1	71	530 (Y)
1705430	18	24	60	1	85	530 (Y)
1705435	24	24	36	1	67	530 (Y)
1705440	24	24	48	1	83	530 (Y)
1705445	24	24	60	1	99	530 (Y)
1705450	24	24	72	1	105	530 (Y)

Black



Part No.	Height	Depth	Width	# Latches per Door	Wt. (lb)	Cat.
1705905*	18	18	36	1	51	530 (Y)
1705910*	18	18	48	1	62	530 (Y)
1705915*	18	18	60	1	73	530 (Y)
1705920*	18	24	36	1	58	530 (Y)
1705925*	18	24	48	1	71	530 (Y)
1705930*	18	24	60	1	85	530 (Y)
1705935*	24	24	36	1	67	530 (Y)
1705940*	24	24	48	1	83	530 (Y)
1705945*	24	24	60	1	99	530 (Y)
1705950*	24	24	72	1	105	530 (Y)

White‡



Part No.	Height	Depth	Width	# Latches per Door	Wt. (lb)	Cat.
1706905* ‡	18	18	36	1	51	530 (Y)
1706910* ‡	18	18	48	1	62	530 (Y)
1706915* ‡	18	18	60	1	73	530 (Y)
1706920* ‡	18	24	36	1	58	530 (Y)
1706925* ‡	18	24	48	1	71	530 (Y)
1706930* ‡	18	24	60	1	85	530 (Y)
1706935* ‡	24	24	36	1	67	530 (Y)
1706940* ‡	24	24	48	1	83	530 (Y)
1706945* ‡	24	24	60	1	99	530 (Y)
1706950* ‡	24	24	72	1	105	530 (Y)

‡ White is not stocked. Please call for lead time.

See pg. 28-29 for Underbody Mounting Brackets

XD Aluminum Underbody

DROP DOOR WITH 3-POINT COMPRESSION LATCH

- .125" thick smooth aluminum with rigid extruded box frame (.100" thick diamond tread aluminum door on certain models)
- Die-cast T-handle compression latch with 3-point locking system
- Stainless steel bolt-on continuous hinge with oversized 1/4" pin
- Built-in rain gutter with automotive bulb seal

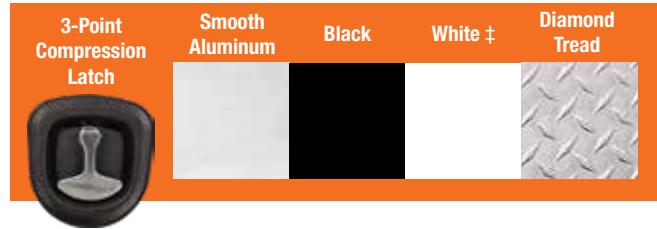

Smooth Aluminum



Part No.	Height	Depth	Width	# Latches per Door	Wt. (lb)	Cat.
1706400	18	18	24	1	43.80	530 (Y)
1706403	18	18	30	1	50.45	530 (Y)
1706405	18	18	36	1	56.70	530 (Y)
1706410	18	18	48	1	64.45	530 (Y)
1706415	18	18	60	1	77.80	530 (Y)
1706420	18	24	36	1	56.68	530 (Y)
1706425	18	24	48	1	78.87	530 (Y)
1706430	18	24	60	1	82.70	530 (Y)

Black



Part No.	Height	Depth	Width	# Latches per Door	Wt. (lb)	Cat.
1706960*	18	18	24	1	43.80	530 (Y)
1706963*	18	18	30	1	50.45	530 (Y)
1706965*	18	18	36	1	56.70	530 (Y)
1706970*	18	18	48	1	64.45	530 (Y)
1706975*	18	18	60	1	77.80	530 (Y)
1706980*	18	24	36	1	56.68	530 (Y)
1706985*	18	24	48	1	78.87	530 (Y)
1706990*	18	24	60	1	82.70	530 (Y)

White‡



Part No.	Height	Depth	Width	# Latches per Door	Wt. (lb)	Cat.
1707960* ‡	18	18	24	1	43.80	530 (Y)
1707963* ‡	18	18	30	1	50.45	530 (Y)
1707965* ‡	18	18	36	1	56.70	530 (Y)
1707970* ‡	18	18	48	1	64.45	530 (Y)
1707975* ‡	18	18	60	1	77.80	530 (Y)
1707980* ‡	18	24	36	1	56.68	530 (Y)
1707985* ‡	18	24	48	1	78.87	530 (Y)
1707990* ‡	18	24	60	1	82.70	530 (Y)

‡ White is not stocked. Please call for lead time.

XD Aluminum/Aluminum Underbody with Drawers

Diamond Tread Aluminum



Part No.	Height	Depth	Width	# Latches per Door	Wt. (lb)	Cat.
1706500	18	18	24	1	41	530 (Y)
1706503	18	18	30	1	48	530 (Y)
1706505	18	18	36	1	56	530 (Y)
1706510	18	18	48	1	69	530 (Y)
1706515	18	18	60	1	78.8	530 (Y)
1706520*	18	24	36	1	66.6	530 (Y)
1706525*	18	24	48	1	79.8	530 (Y)
1706530*	18	24	60	1	83.7	530 (Y)

ALUMINUM UNDERBODY WITH DRAWERS

- .100" thick diamond tread aluminum
- Drawer comes with adjustable dividers and 100 lb rated 16" slides
- Drop-down recessed door
- Locking die-cast T-handle compression latch
- Continuous hidden hinge
- Replaceable gasket sealing system
- Door opening: flat surface mount (90°) or underbody mount (180°)
- Reinforced door backbone
- Aircraft grade door cables



Part No.	Height	Depth	Width	# Latches per Door	Wt. (lb)	Cat.
1712200	20	18	24	1	50	530 (Y)
1712205	20	18	36	1	66	530 (Y)
1712210	20	18	48	1	85	530 (Y)

Aluminum Underbodies

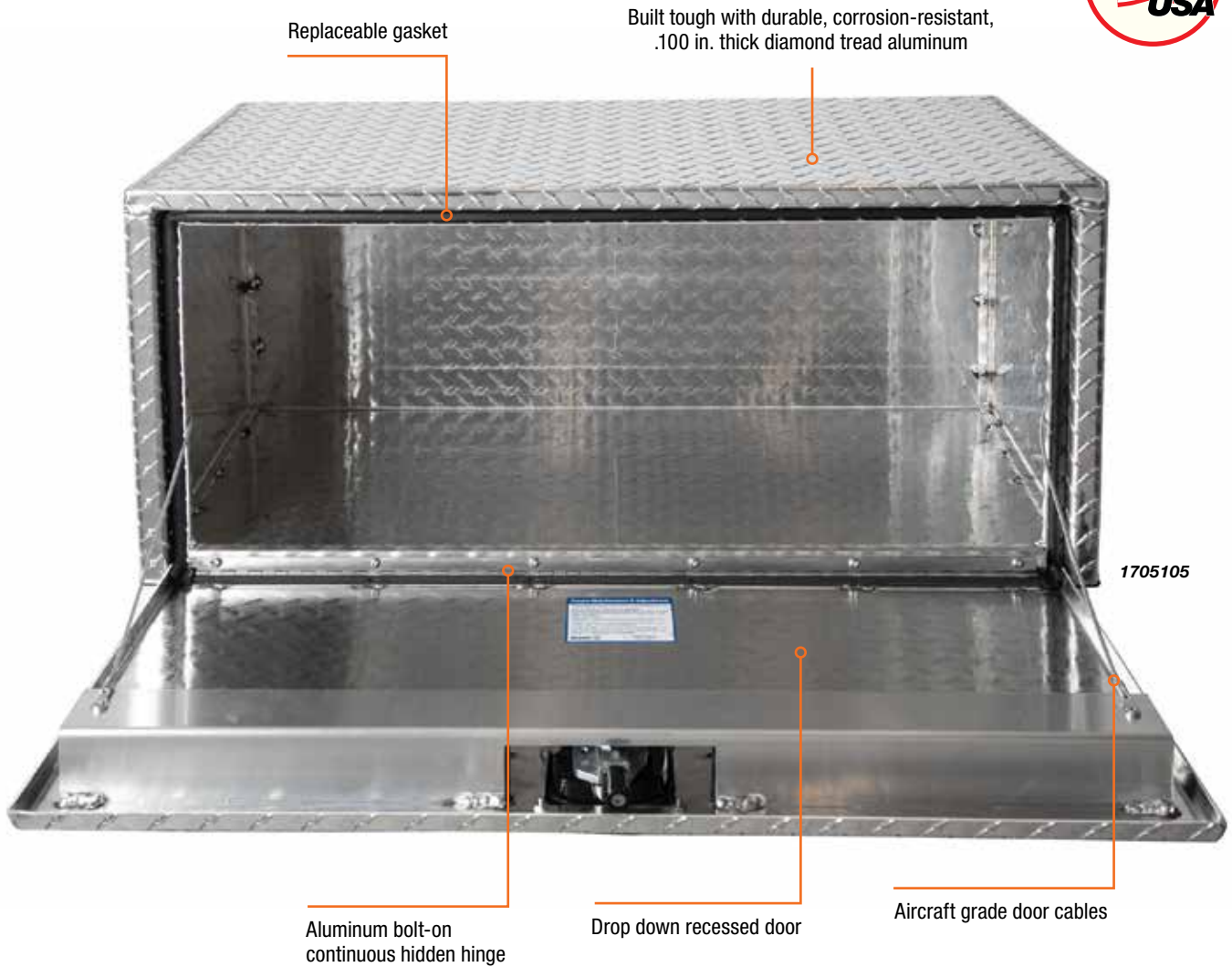

Aluminum Features



Replaceable gasket



Aluminum bolt-on continuous hidden hinge



Aircraft grade door cables

COMPRESSION LATCH

- .100" thick diamond tread aluminum
- Drop-down recessed door
- Locking die-cast T-handle compression latch
- Aluminum bolt-on continuous hidden hinge
- Replaceable gasket sealing system
- Aircraft grade door cables
- Reinforced door backbone on boxes 48" and wider
- Door opening: flat surface mount (90°) or underbody mount (180°)



Diamond Tread, Single Latch



Part No.	Height	Depth	Width	# Latches per Door	Wt. (lb)	Cat.
1705148	14	12	16	1	18	530 (Y)
1705149	14	12	18	1	19	530 (Y)
1705150	14	12	24	1	23	530 (Y)
1705153	14	12	30	1	26	530 (Y)
1705160	14	16	24	1	25	530 (Y)
1705102	18	18	14	1	24.6	530 (Y)
1705101	18	18	18	1	30	530 (Y)
1705100	18	18	24	1	32.5	530 (Y)
1705103	18	18	30	1	38.5	530 (Y)
1705105	18	18	36	1	43	530 (Y)
1705118	20	20	36	1	46	530 (Y)
1705119*	18	24	36	1	56	530 (Y)
1705130	24	24	24	1	45	530 (Y)
1705133	24	24	30	1	52	530 (Y)
1705135	24	24	36	1	59.5	530 (Y)

Diamond Tread, Dual Latch



Part No.	Height	Depth	Width	# Latches per Door	Wt. (lb)	Cat.
1705110	18	18	48	2	56.5	530 (Y)
1705115	18	18	60	2	66	530 (Y)
1705120	18	24	48	2	63.5	530 (Y)
1705125*	18	24	60	2	82	530 (Y)
1705140	24	24	48	2	75	530 (Y)
1705145	24	24	60	2	88.5	530 (Y)
1705147	24	24	72	2	97	530 (Y)

Aluminum Underbody

Black Diamond Tread, Single Latch



Part No.	Height	Depth	Width	# Latches per Door	Wt. (lb)	Cat.
1725148*	14	12	16	1	18	530 (Y)
1725149*	14	12	18	1	22.5	503 (Y)
1725150	14	12	24	1	22.5	530 (Y)
1725153	14	12	30	1	27	530 (Y)
1725160	14	16	24	1	26	530 (Y)
1725102*	18	18	14	1	27	530 (Y)
1725101	18	18	18	1	27	530 (Y)
1725100	18	18	24	1	30	530 (Y)
1725103	18	18	30	1	38	530 (Y)
1725105	18	18	36	1	42	530 (Y)
1725116*	18	24	30	1	39.7	530 (Y)
1725119*	18	24	36	1	56	530 (Y)
1725125*	18	24	60	1	64	530 (Y)
1725118*	20	20	36	1	64	530 (Y)
1725130	24	24	24	1	46	530 (Y)
1725133	24	24	30	1	53	530 (Y)
1725135	24	24	36	1	59	530 (Y)

Black Diamond Tread, Dual Latch



Part No.	Height	Depth	Width	# Latches per Door	Wt. (lb)	Cat.
1725110	18	18	48	2	52	530 (Y)
1725115	18	18	60	2	70	530 (Y)
1725120	18	24	48	2	64	530 (Y)
1725140	24	24	48	2	76	530 (Y)
1725145	24	24	60	2	89	530 (Y)
1725147*	24	24	72	2	97	530 (Y)

Textured Matte Black Diamond Tread, Single Latch



Part No.	Height	Depth	Width	# Latches per Door	Wt. (lb)	Cat.
1715100	18	18	24	1	30	530 (Y)
1715105	18	18	36	1	42	530 (Y)

Textured Matte Black Diamond Tread, Dual Latch



Part No.	Height	Depth	Width	# Latches per Door	Wt. (lb)	Cat.
1715110	18	18	48	2	52	530 (Y)
1715115	18	18	60	2	70	530 (Y)

3-POINT COMPRESSION LATCH

- .100" thick diamond tread aluminum
- Drop-down recessed door
- Die-cast T-handle compression latch with 3-point locking system
- Aluminum bolt-on continuous hidden hinge
- Replaceable gasket sealing system
- Aircraft grade door cables
- Reinforced door backbone
- Door opening: flat surface mount (90°) or underbody mount (180°)



Diamond Tread



1735100

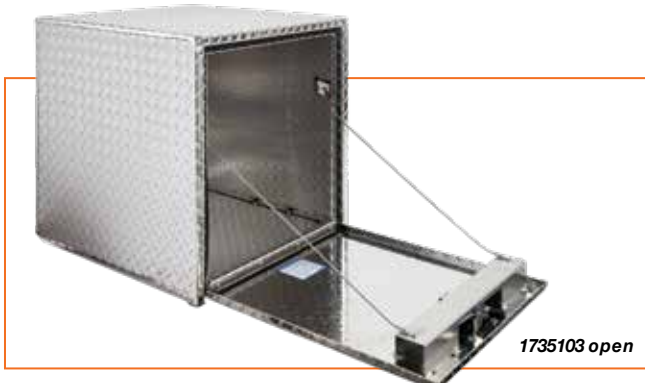

1735103 open

Part No.	Height	Depth	Width	# Latches per Door	Wt. (lb)	Cat.
1735100	18	18	24	1	32.5	530 (Y)
1735103	18	18	30	1	38	530 (Y)
1735105	18	18	36	1	44	530 (Y)
1735130	24	24	24	1	45	530 (Y)
1735133	24	24	30	1	58	530 (Y)
1735135	24	24	36	1	63	530 (Y)



Aluminum Underbody

BARN DOOR WITH 3-POINT COMPRESSION LATCH

- .125" thick diamond tread or smooth aluminum
- Side-hinged doors with reversible right/left locking door
- Die-cast T-handle compression latch with 3-point locking system
- Aluminum bolt-on continuous hinge with oversize 1/4" pin
- Automotive D-bulb seal
- Can mount on flat surface
- Unobstructed box opening with no center post

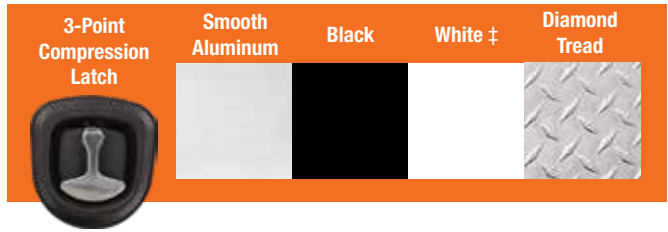

Smooth Aluminum, Double Door



Part No.	Height	Depth	Width	# Latches per Door	Wt. (lb)	Cat.
1705303	18	18	30	1, 2 Doors	42	530 (Y)
1705305	18	18	36	1, 2 Doors	49	530 (Y)
1705310	18	18	48	1, 2 Doors	63	530 (Y)
1705315	18	18	60	1, 2 Doors	77	530 (Y)
1705333	24	24	30	1, 2 Doors	69	530 (Y)
1705335	24	24	36	1, 2 Doors	75	530 (Y)
1705340	24	24	48	1, 2 Doors	87	530 (Y)
1705345	24	24	60	1, 2 Doors	99	530 (Y)
1705350	24	24	72	1, 2 Doors	98	530 (Y)

Black, Double Door



Part No.	Height	Depth	Width	# Latches per Door	Wt. (lb)	Cat.
1705803*	18	18	30	1, 2 Doors	42	530 (Y)
1705805*	18	18	36	1, 2 Doors	49	530 (Y)
1705810*	18	18	48	1, 2 Doors	63	530 (Y)
1705815*	18	18	60	1, 2 Doors	77	530 (Y)
1705833*	24	24	30	1, 2 Doors	69	530 (Y)
1705835*	24	24	36	1, 2 Doors	75	530 (Y)
1705840*	24	24	48	1, 2 Doors	87	530 (Y)
1705845*	24	24	60	1, 2 Doors	99	530 (Y)
1705850*	24	24	72	1, 2 Doors	98	530 (Y)

White‡, Double Door



Part No.	Height	Depth	Width	# Latches per Door	Wt. (lb)	Cat.
1706803* ‡	18	18	30	1, 2 Doors	42	530 (Y)
1706805* ‡	18	18	36	1, 2 Doors	49	530 (Y)
1706810* ‡	18	18	48	1, 2 Doors	63	530 (Y)
1706815* ‡	18	18	60	1, 2 Doors	77	530 (Y)
1706833* ‡	24	24	30	1, 2 Doors	69	530 (Y)
1706835* ‡	24	24	36	1, 2 Doors	75	530 (Y)
1706840* ‡	24	24	48	1, 2 Doors	87	530 (Y)
1706845* ‡	24	24	60	1, 2 Doors	99	530 (Y)
1706850* ‡	24	24	72	1, 2 Doors	98	530 (Y)

‡ White is not stocked. Please call for lead time.

Aluminum/Polymer Underbody

Diamond Tread Aluminum, Double Door



Part No.	Height	Depth	Width	# Latches per Door	Wt. (lb)	Cat.
1705205	18	18	36	1, 2 Doors	49	530 (Y)
1705210	18	18	48	1, 2 Doors	63	530 (Y)
1705215	18	18	60	1, 2 Doors	77	530 (Y)
1702235	24	24	36	1, 2 Doors	71	530 (Y)
1702240	24	24	48	1, 2 Doors	76	530 (Y)
1702250	24	24	60	1, 2 Doors	87	530 (Y)

BARN DOOR WITH COMPRESSION LATCH

- .125" thick diamond tread or smooth aluminum
- Side-hinged door with reversible right/left locking door
- Die-cast T-handle compression latch
- Aluminum bolt-on continuous hinge with oversize 1/4" pin
- Automotive D-bulb seal
- Can mount on flat surface
- Unobstructed box opening with no center post



Part No.	Height	Depth	Width	# Latches per Door	Wt. (lb)	Cat.
1705201	18	18	18	1	27	530 (Y)
1705200	18	18	24	1	36	530 (Y)
1705203	18	18	30	1	42	530 (Y)

Polymer Underbody

3-POINT T-HANDLE LATCH

Black, Single Latch

- Constructed of high-density polyethylene
- Drop down door
- Locking stainless steel 3-point T-handle latch
- Stainless steel hinge pin
- Replaceable gasket sealing system
- Aircraft grade door cables
- Molded double-wall door design



Part No.	Height	Depth	Width	# Latches per Door	Wt. (lb)	Cat.
1717100	18	18	24	1	24	530 (Y)
1717105	18	18	36	1	31	530 (Y)
1717110	18	18	48	1	42	530 (Y)

Underbody Mounting Brackets

STEEL

- Sold in boxed pairs
- Universal hole pattern for quick and easy mounting
- Available with welded braces or bolt-on braces
- Available in heavy-duty structural steel (optional)
- Constructed of formed (optional) 3" wide steel C-channel, black powder-coated for corrosion resistance
- Hardware not included

Formed, Welded



Part No.	Description	Height	Depth	Wt. (lb)	Cat.
1701006	Formed Welded Brackets	18	18	16	531 (Y)
1701011	Formed Welded Brackets	18	24	19	531 (Y)
1701016	Formed Welded Brackets	24	24	22	531 (Y)

Formed, Bolted



Part No.	Description	Height	Depth	Wt. (lb)	Cat.
1701006B	Formed Bolted Brackets	18	18	16	531 (Y)
1701011B	Formed Bolted Brackets	18	24	19	531 (Y)

Heavy Duty, Structural Welded



Part No.	Description	Height	Depth	Wt. (lb)	Cat.
1701005	Structural Welded Brackets	18	18	24	531 (Y)
1701010	Structural Welded Brackets	18	24	27	531 (Y)
1701015	Structural Welded Brackets	24	24	32	531 (Y)
1701012	Structural Welded Brackets	27	18	47	531 (Y)

Heavy Duty, Structural Bolted



Part No.	Description	Height	Depth	Wt. (lb)	Cat.
1701005B	Structural Bolted Brackets	18	18	24	531 (Y)
1701010B	Structural Bolted Brackets	18	24	27	531 (Y)

Underbody Mounting Brackets

STAINLESS STEEL

- Sold in boxed pairs
- Universal hole pattern for quick and easy mounting
- Welded braces
- 3/16" thick 304 stainless steel construction
- Hardware not included

Formed, Welded



Part No.	Description	Height	Depth	Wt. (lb)	Cat.
1701031	Welded Brackets	18	18	19	531 (Y)
1701041	Welded Brackets	18	24	22	531 (Y)

ALUMINUM

- Sold in boxed pairs
- Welded braces
- Aluminum construction
- 1/4" formed aluminum angles

Formed, Welded



Part No.	Description	Height	Depth	Wt. (lb)	Cat.
1701030	Welded Brackets	18	18	7.5	531 (Y)
1701040	Welded Brackets	24	24	10	531 (Y)

FOR POLYMER UNDERBODIES

- Sold in boxed pairs
- Constructed of 3/16" thick 2" wide C-channel A-36 steel
- Black powder-coated
- Channel fits inside toolbox ribs
- Pre-drilled 7/16" mounting holes (nuts/bolts not included)

Formed, Welded



Part No.	Description	Height	Depth	Wt. (lb)	Cat.
1701000	Brackets for 24" and 36" Poly	15	14	14.3	530 (Y)
1701001	Brackets for 48" Poly	15	14	22.3	530 (Y)



TO



TOPSIDER

Topsiders



18 Drawer Parts Cabinet

- Designed to fit topsiders
- Store and index hardware or small parts
- White powder-coated steel cabinet
- Injection-molded plastic drawers with stops
- Includes two dividers per drawer
- Pre-drilled mounting holes (hardware not included)

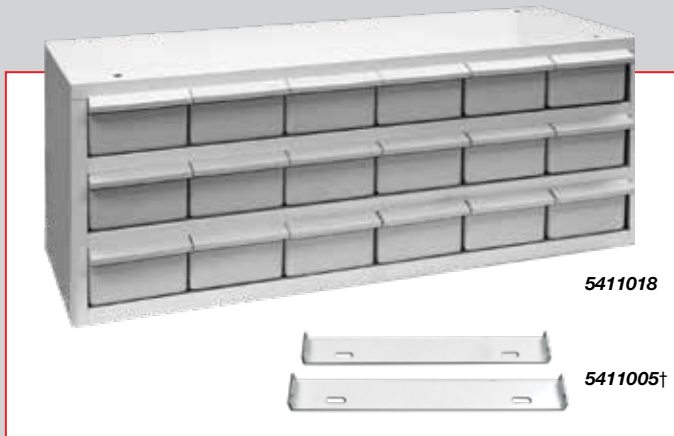

Part No.	Description	Height	Depth	Width	Wt. (lb)	Cat.
5411018	18 Drawer Cabinet	12	11-3/4	32-1/2	30.8	541 (N)
5411000	Drawer Replacement	3-1/4	12-1/4	5	0.61	541 (N)
5411005	Mounting Bracket for Cabinet†	1-3/4	-	13-3/4	1.25	541 (N)

†Sold separately

XD STEEL TOPSIDERS

Black, Double Door

* See page 6-7 for details



Part No.	Height	Depth	Width	# Latches per Door	Wt. (lb)	Cat.
1742315†	18	18	60	1	175	530 (Y)
1742325†	18	18	72	1	202	530 (Y)
1742335†	18	18	90	1	228	530 (Y)
1742336†	18	18	96	1	250	530 (Y)

†Boxes can be used as topsiders and underbodies

T-HANDLE LATCH

- 16 gauge steel box with 14 gauge steel doors
- Drop-down recessed doors
- Locking stainless steel T-handle latches
- Bolt-on continuous hidden hinge
- Replaceable gasket sealing system
- Aircraft grade door cables
- Optional quick-mount trays
- Includes J-hooks for no-drill mounting and protective side rail pads
- Door opening: flat surface mount (90°)

Black

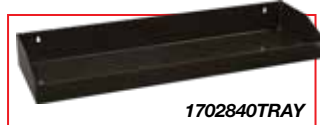

White



Part No.	Height	Depth	Width	# Latches per Door	Wt. (lb)	Cat.
1702940	16	13	72	1	115	530 (Y)
1702950	16	13	88	1	120	530 (Y)
1702960	16	13	96	1	128	530 (Y)

Optional Trays

Part No.	Height	Depth	Width	Wt. (lb)	Cat.
1702940TRAY	2.25/4	10.75	35	11	530 (Y)
1702950TRAY	2.25/4	10.75	43	14	530 (Y)
1702960TRAY	2.25/4	10.75	47	15	530 (Y)

Part No.	Height	Depth	Width	# Latches per Door	Wt. (lb)	Cat.
1702840	16	13	72	1	115	530 (Y)
1702850	16	13	88	1	120	530 (Y)
1702860	16	13	96	1	128	530 (Y)

Optional Trays

Part No.	Height	Depth	Width	Wt. (lb)	Cat.
1702840TRAY	2.25/4	10.75	35	11	530 (Y)
1702850TRAY	2.25/4	10.75	43	14	530 (Y)
1702860TRAY	2.25/4	10.75	47	15	530 (Y)

Aluminum Topsider

FLIP UP DOOR WITH COMPRESSION LATCH

- Gas shock lifts and holds door open at 110°
- .100" thick diamond tread aluminum
- Locking die-cast T-handle compression latch
- Full length stainless steel bolt-on continuous hidden hinge
- Recessed door design with large 13" tall opening
- Integrated above door rain gutter
- Reinforced door backbone
- Replaceable gasket sealing system



Diamond Tread, Single Latch



Part No.	Height	Depth	Width	# Latches per Door	Wt. (lb)	Cat.
1701768	18	16	96	1	103	530 (Y)

Black



Part No.	Height	Depth	Width	# Latches per Door	Wt. (lb)	Cat.
1721768*	18	16	96	1	103	530 (Y)

Matte Black



Part No.	Height	Depth	Width	# Latches per Door	Wt. (lb)	Cat.
1722768*	18	16	96	1	103	530 (Y)

DIAMOND TREAD DROP DOOR WITH COMPRESSION LATCH

- .100" thick diamond tread aluminum
- Locking die-cast T-handle compression latch
- Full length stainless steel bolt-on continuous hidden hinge
- Replaceable gasket sealing system
- Aircraft grade door cables
- Includes J-hooks for no-drill mounting and protective side rail pads
- Door opening: flat surface mount (90°)



Diamond Tread, Single Latch



Part No.	Height	Depth	Width	# Latches per Door	Wt. (lb)	Cat.
1701551	16	13	72	1	78	530 (Y)
1701556	16	13	88	1	89	530 (Y)
1701565†	18	16	90	1	99	530 (Y)

†Boxes can be used as topsiders and underbodies

Diamond Tread, Dual Latch



Part No.	Height	Depth	Width	# Latches per Door	Wt. (lb)	Cat.
1701565	16	13	96	2	92	530 (Y)
1701568†	18	16	96	2	103	530 (Y)

†Boxes can be used as topsiders and underbodies

Black Diamond Tread, Single Latch



Part No.	Height	Depth	Width	# Latches per Door	Wt. (lb)	Cat.
1721551	16	13	72	1	78	530 (Y)
1721556	16	13	88	1	89	530 (Y)
1721565†	18	16	90	1	99	530 (Y)

†Boxes can be used as topsiders and underbodies

Black Diamond Tread, Dual Latch



Part No.	Height	Depth	Width	# Latches per Door	Wt. (lb)	Cat.
1721561	16	13	96	2	92	530 (Y)
1721568†	18	16	96	2	103	530 (Y)

†Boxes can be used as topsiders and underbodies

Textured Matte Black Diamond Tread, Single Latch



Part No.	Height	Depth	Width	# Latches per Door	Wt. (lb)	Cat.
1722551	16	13	72	1	78	530 (Y)

†Boxes can be used as topsiders and underbodies

Textured Matte Black Diamond Tread, Dual Latch



Part No.	Height	Depth	Width	# Latches per Door	Wt. (lb)	Cat.
1722568†	18	16	96	2	103	530 (Y)

†Boxes can be used as topsiders and underbodies

Aluminum Topsider

SMOOTH ALUMINUM DROP DOOR WITH COMPRESSION LATCH

- .100" thick smooth aluminum
- Locking die-cast T-handle compression latch
- Full length stainless steel bolt-on continuous hidden hinge
- Replaceable gasket sealing system
- Aircraft grade door cables
- Includes J-hooks for no-drill mounting and protective side rail pads
- Door opening: flat surface mount (90°)



Smooth Aluminum, Single Latch



Part No.	Height	Depth	Width	# Latches per Door	Wt. (lb)	Cat.
1751651	16	13	72	1	78	530 (Y)
1751656	16	13	88	1	89	530 (Y)
1751663†	18	16	72	1	93	530 (Y)
1751664†	18	16	88	1	96	530 (Y)
1751665†	18	16	90	1	99	530 (Y)

†Boxes can be used as topsiders and underbodies

Smooth Aluminum, Dual Latch



Part No.	Height	Depth	Width	# Latches per Door	Wt. (lb)	Cat.
1751661	16	13	96	2	92	530 (Y)
1751668†	18	16	96	2	103	530 (Y)

†Boxes can be used as topsiders and underbodies

Smooth Aluminum, Single Latch, Black



Part No.	Height	Depth	Width	# Latches per Door	Wt. (lb)	Cat.
1752151*	16	13	72	1	78	530 (Y)
1752156*	16	13	88	1	89	530 (Y)
1752163*†	18	16	72	1	93	530 (Y)
1752164*†	18	16	88	1	96	530 (Y)
1752165*†	18	16	90	1	99	530 (Y)

†Boxes can be used as topsiders and underbodies

Smooth Aluminum, Dual Latch, Black



Part No.	Height	Depth	Width	# Latches per Door	Wt. (lb)	Cat.
1752161*	16	13	96	2	92	530 (Y)
1752168*†	18	16	96	2	103	530 (Y)

†Boxes can be used as topsiders and underbodies

Aluminum Topsider

Smooth Aluminum, Single Latch, White



Part No.	Height	Depth	Width	# Latches per Door	Wt. (lb)	Cat.
1753151*	16	13	72	1	78	530 (Y)
1753156*	16	13	88	1	89	530 (Y)
1753163*†	18	16	72	1	93	530 (Y)
1753164*†	18	16	88	1	96	530 (Y)
1753165*†	18	16	90	1	99	530 (Y)

†Boxes can be used as topsiders and underbodies

Smooth Aluminum, Dual Latch, White



Part No.	Height	Depth	Width	# Latches per Door	Wt. (lb)	Cat.
1753161*	16	13	96	2	92	530 (Y)
1753168*†	18	16	96	2	103	530 (Y)

†Boxes can be used as topsiders and underbodies



Aluminum Topsider

CONTRACTOR WITH LOWER COMPARTMENT

- .056" thick diamond tread aluminum
- Gas shocks lift and open door at over 90 degree angle
- Comes with two doors: top flip-up door and bottom drop door
- Locking stainless steel T-handle latches
- Replaceable gasket sealing system
- Aircraft grade door cables
- Mounting hardware included



1705640 open

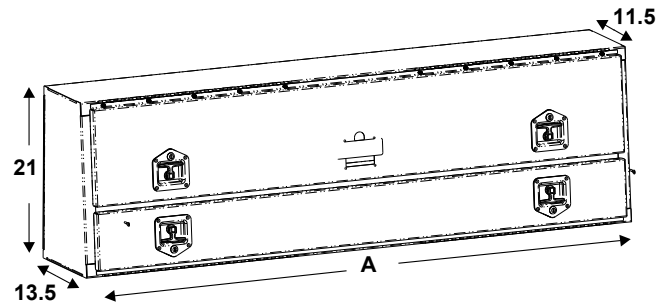

Diamond Tread



1705640

Part No.	Top Doors	Bottom Doors	Height	Depth	Width (A)	Wt. (lb)	Cat.
1705640	1	1	21	13.5/11.5	72	68.5	530 (Y)
1705650	1	1	21	13.5/11.5	88	83.5	530 (Y)
1705660	1	1	21	13.5/11.5	96	88.5	530 (Y)

Depth indicates bottom/top O.D.

Black Diamond Tread



1725640

Part No.	Top Doors	Bottom Doors	Height	Depth	Width (A)	Wt. (lb)	Cat.
1725640	1	1	21	13.5/11.5	72	68.5	530 (Y)
1725650	1	1	21	13.5/11.5	88	83.5	530 (Y)
1725660	1	1	21	13.5/11.5	96	88.5	530 (Y)

Depth indicates bottom/top O.D.

CONTRACTOR WITH TWO LOWER DRAWERS

- .056" thick diamond tread aluminum
- Gas shocks lift and open door at over 90 degree angle
- Locking stainless steel T-handle latches
- Replaceable gasket sealing system
- Bottom drawers come with adjustable dividers and 100 lb rated 12" slides
- Mounting legs and hardware included

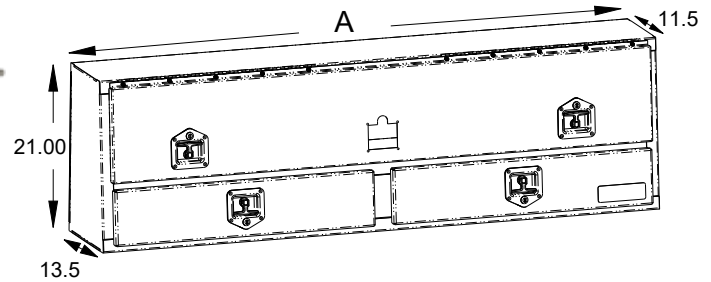

Diamond Tread



Part No.	Top Doors	Bottom Drawers	Height	Depth	Width (A)	Wt. (lb)	Cat.
1705641	1	2	21	13.5/11.5	72	58	530 (Y)
1705651	1	2	21	13.5/11.5	88	530 (Y)	

Depth indicates bottom/top O.D.

Black Diamond Tread



Part No.	Top Doors	Bottom Drawers	Height	Depth	Width (A)	Wt. (lb)	Cat.
1725641	1	2	21	13.5/11.5	72	58	530 (Y)
1725651	1	2	21	13.5/11.5	88	91	530 (Y)

Depth indicates bottom/top O.D.



BAC

Choose a style ...

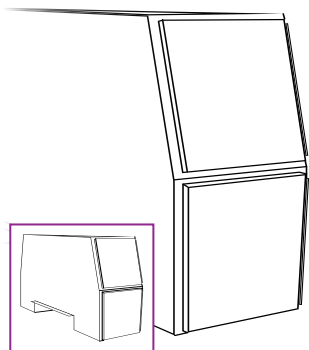

4 DOORS, SLANTED DOOR

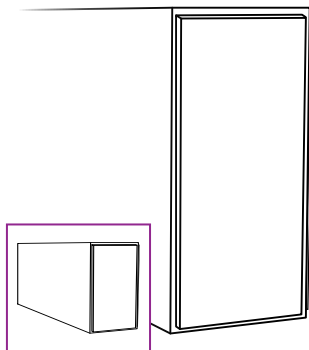

2 DOORS, STRAIGHT SIDES

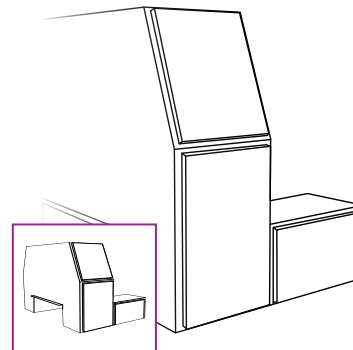

L-PACK

Choose a floor ...

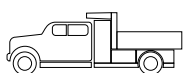
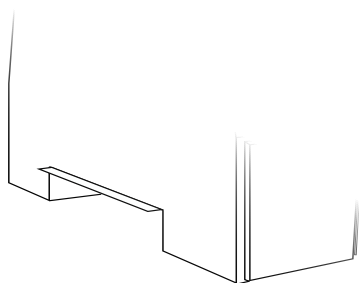

OFFSET FLOOR
(for conventional cabs)

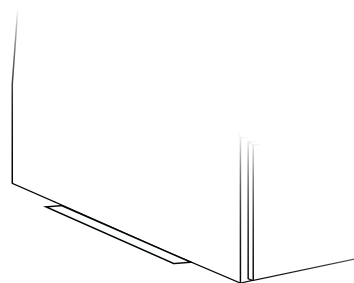

FLAT FLOOR
(for cab-over trucks)

Choose a material ...



DIAMOND TREAD
ALUMINUM



CARBON STEEL
BLACK

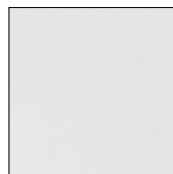

CARBON STEEL
WHITE



CARBON STEEL
PRIMED

СКРАС

4 Doors, Offset Floor

DIAMOND TREAD ALUMINUM



- .100" thick aluminum diamond tread
- Universal spring cushion mounting kit, included with all aluminum backpack boxes, provides flex to reduce strain

CARBON STEEL



- 14 gauge steel box with 12 gauge steel doors
- Optional U-Bolt mounting kit sold separately (see page 58)

Common Features



Manufactured by a talented workforce in Northeast Ohio



Backpack mounting adapter recommended for all 2017+ Ford® applications (see page 58 for details)



Stainless steel bolt-on continuous hidden hinges



Two shelves to organize tools and equipment plus two folding passenger side J-hooks

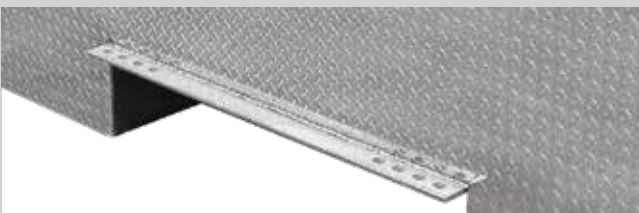

Integral mounting rail for quick and easy installation



Doors open easily with gas powered shocks plus built-in rain gutter with automotive bulb seal

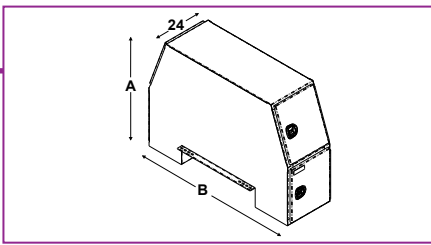

Diamond Tread Aluminum

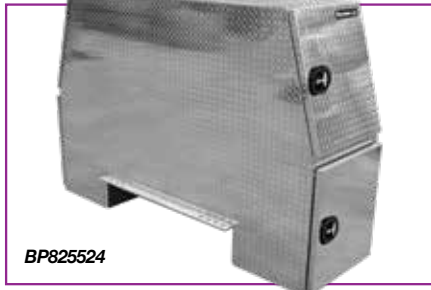

BP825524

****CAUTION:** Failure to use supplied mounting kit may void warranty on Aluminum Backpack Boxes

Compression Latch



Diamond Tread



Spring Cushion Mounting Kit**



Part No.	Total Height (A)	Depth	Width (B)	Wt. (lb)	Cat.
BP825524	55	24	82	234	592 (Y)
BP826224	62	24	82	254	592 (Y)
BP826524*	65	24	82	316	592 (Y)
BP827024	70	24	82	316	592 (Y)
BP925824	58	24	92	255	592 (Y)



For optional underbody box, see pages 52-53.

Steel, Black Powder-Coated



BP855524B

T-Handle Latch



Black



White



Primed



Part No.	Total Height (A)	Depth	Width (B)	Wt. (lb)	Cat.
BP855524B	55	24	85	536	592 (Y)
BP826524B*	65	24	82	600	592 (Y)
BP925824B*	58	24	92	576	592 (Y)



For optional underbody box, see pages 52-53.

Steel, White Powder-Coated



BP855524W

Part No.	Total Height (A)	Depth	Width (B)	Wt. (lb)	Cat.
BP855524W	55	24	85	538	592 (Y)
BP826524W*	65	24	82	600	592 (Y)
BP925824W*	58	24	92	576	592 (Y)



For optional underbody box, see pages 52-53.

Steel, Primed Powder-Coated



BP855524P

Part No.	Total Height (A)	Depth	Width (B)	Wt. (lb)	Cat.
BP855524P	55	24	85	538	592 (Y)
BP826524P*	65	24	82	538	592 (Y)
BP925824P*	58	24	92	576	592 (Y)



For optional underbody box, see pages 52-53.

4 Doors, Flat Floor

DIAMOND TREAD ALUMINUM



- .100" thick aluminum diamond tread
- Universal spring cushion mounting kit, included with all aluminum backpack boxes, provides flex to reduce strain

CARBON STEEL



- 14 gauge steel box with 12 gauge steel doors
- Optional U-Bolt mounting kit sold separately (see page 58)

Common Features



Manufactured by a talented workforce in Northeast Ohio

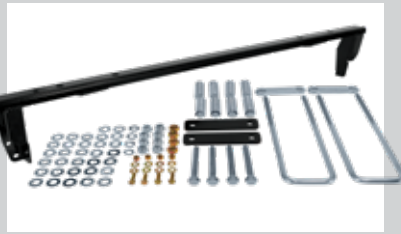

Backpack mounting adapter recommended for all 2017+ Ford® applications (see page 58 for details)



Stainless steel bolt-on continuous hidden hinges

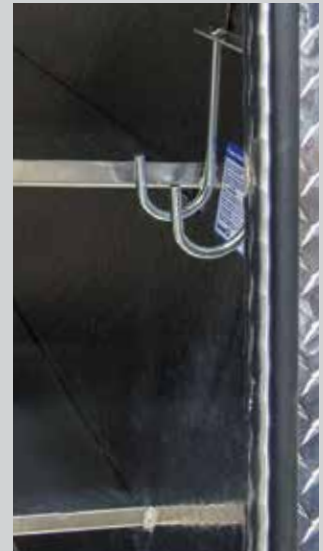

Two shelves to organize tools and equipment plus two folding passenger side J-hooks



Integral mounting rail for quick and easy installation



Doors open easily with gas powered shocks plus built-in rain gutter with automotive bulb seal

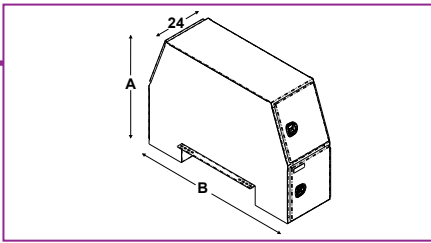

Diamond Tread Aluminum



****CAUTION:** Failure to use supplied mounting kit may void warranty on Aluminum Backpack Boxes

Compression Latch	Diamond Tread	Spring Cushion Mounting Kit**

Part No.	Total Height (A)	Depth	Width (B)	Wt. (lb)	Cat.
BP824624	46	24	82	216	592 (Y)
BP855924	59	24	85	350	530 (Y)

For optional underbody box, see pages 52-53.

Steel, Black Powder-Coated



Compression Latch	T-Handle Latch	Black	White	Primed

Part No.	Total Height (A)	Depth	Width (B)	Wt. (lb)	Cat.
BP824624B	46	24	82	454	592 (Y)
BP855924B	59	24	85	536	592 (Y)

For optional underbody box, see pages 52-53.

Steel, White Powder-Coated



Part No.	Total Height (A)	Depth	Width (B)	Wt. (lb)	Cat.
BP824624W	46	24	81	454	592 (Y)
BP855924W	59	24	85	536	592 (Y)

For optional underbody box, see pages 52-53.

Steel, Primed Powder-Coated



Part No.	Total Height (A)	Depth	Width (B)	Wt. (lb)	Cat.
BP824624P	46	24	81	454	592 (Y)
BP855924P	59	24	85	536	592 (Y)

For optional underbody box, see pages 52-53.

2 Doors, Offset Floor

DIAMOND TREAD ALUMINUM



- .100" thick aluminum diamond tread
- Universal spring cushion mounting kit, included with all aluminum backpack boxes, provides flex to reduce strain

CARBON STEEL



- 14 gauge steel box with 12 gauge steel doors
- Optional U-Bolt mounting kit sold separately (see page 58)

Common Features



Manufactured by a talented workforce in Northeast Ohio



Backpack mounting adapter recommended for all 2017+ Ford® applications (see page 58 for details)



Stainless steel bolt-on continuous hidden hinges



Two shelves to organize tools and equipment plus two folding passenger side J-hooks

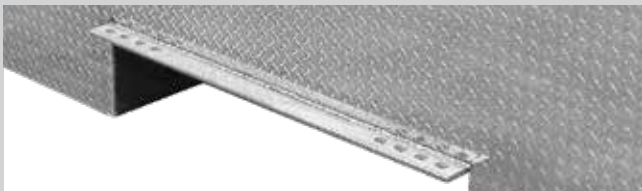

Integral mounting rail for quick and easy installation



Doors open easily with gas powered shocks plus built-in rain gutter with automotive bulb seal

Diamond Tread Aluminum



BP965724

****CAUTION:** Failure to use supplied mounting kit may void warranty on Aluminum Backpack Boxes

Part No.	Total Height	Depth	Width	Wt. (lb)	Cat.
BP965724*	57	24	96	262	592 (Y)



Steel, Black Powder-Coated



BP965724B

Part No.	Total Height	Depth	Width	Wt. (lb)	Cat.
BP965724B*	57	24	96	690	592 (Y)



Steel, White Powder-Coated



BP965724W

Part No.	Total Height	Depth	Width	Wt. (lb)	Cat.
BP965724W*	57	24	96	690	592 (Y)



2 Doors, Flat Floor

DIAMOND TREAD ALUMINUM



- .100" thick aluminum diamond tread
- Universal spring cushion mounting kit, included with all aluminum backpack boxes, provides flex to reduce strain

CARBON STEEL



- 14 gauge steel box with 12 gauge steel doors
- Optional U-Bolt mounting kit sold separately (see page 58)

Common Features



Manufactured by a talented workforce in Northeast Ohio



Backpack mounting adapter recommended for all 2017+ Ford® applications (see page 58 for details)



Stainless steel bolt-on continuous hidden hinges

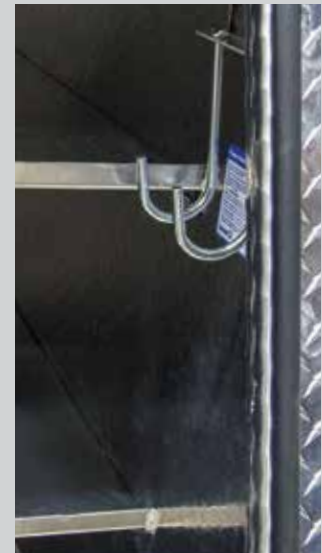

Two shelves to organize tools and equipment plus two folding passenger side J-hooks



Integral mounting rail for quick and easy installation



Doors open easily with gas powered shocks plus built-in rain gutter with automotive bulb seal

Diamond Tread Aluminum



BP964824



Part No.	Total Height	Depth	Width	Wt. (lb)	Cat.
BP964824*	48	24	96	240	592 (Y)



For optional underbody box, see pages 52-53.

****CAUTION:** Failure to use supplied mounting kit may void warranty on Aluminum Backpack Boxes

Steel, Black Powder-Coated



BP964824B



Part No.	Total Height	Depth	Width	Wt. (lb)	Cat.
BP964824B*	48	24	96	700	592 (Y)
BP964824BLL*	48	24	96	700	592 (Y)

BP964824BLL comes with 2 full length adjustable shelves



For optional underbody box, see pages 52-53.

Steel, White Powder-Coated



BP964824W

Part No.	Total Height	Depth	Width	Wt. (lb)	Cat.
BP964824W*	48	24	96	700	592 (Y)
BP964824WLL*	48	24	96	700	592 (Y)

BP964824WLL comes with 2 full length adjustable shelves



For optional underbody box, see pages 56-57.

Steel, Primed Powder-Coated



BP964824P

Part No.	Total Height	Depth	Width	Wt. (lb)	Cat.
BP964824P*	48	24	96	700	592 (Y)



For optional underbody box, see pages 52-53.

L-Pack

DIAMOND TREAD ALUMINUM

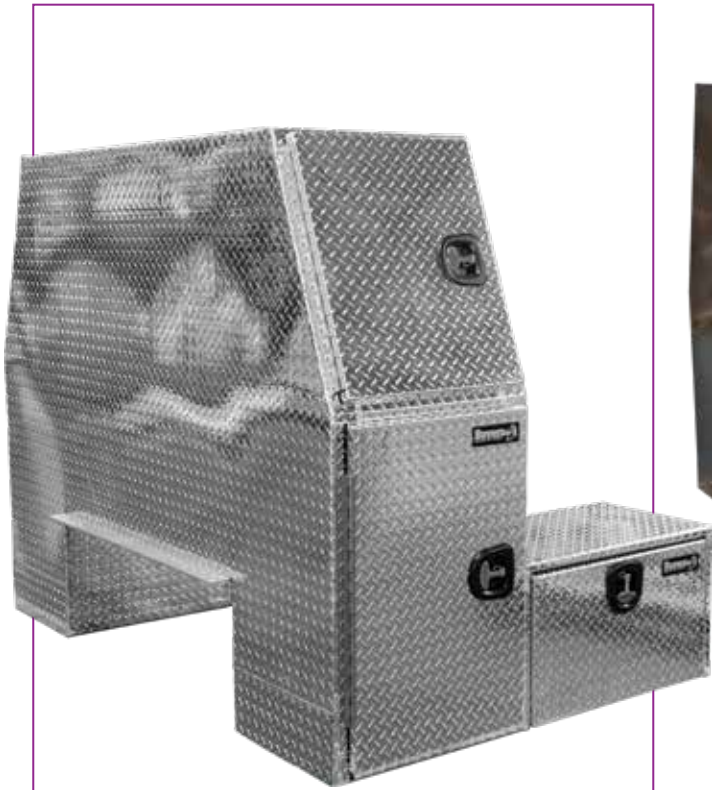

- .100" thick aluminum diamond tread
- Ships with 2 additional 30" underbody boxes welded on to provide additional storage
- Universal spring cushion mounting kit, included with all aluminum backpack boxes, provides flex to reduce strain

CARBON STEEL



- Tough 14 gauge steel body and 12 gauge steel doors with a corrosion resistant powder-coated finish
- Ships with 2 additional 24" underbody boxes bolted on to provide additional storage
- Optional U-Bolt mounting kit sold separately (see page 58)

Common Features



Manufactured by a talented workforce in Northeast Ohio

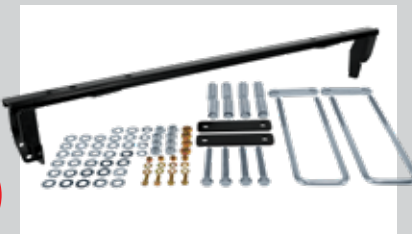

Backpack mounting adapter recommended for all 2017+ Ford® applications (see page 58 for details)



Stainless steel bolt-on continuous hidden hinges

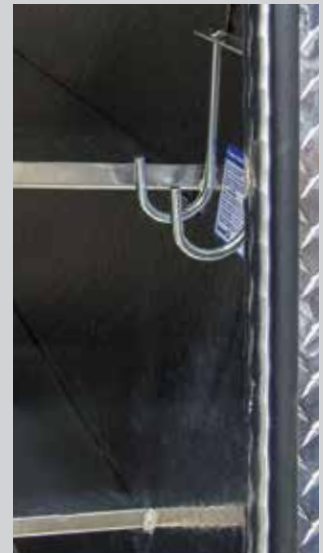

Two shelves to organize tools and equipment plus two folding passenger side J-hooks

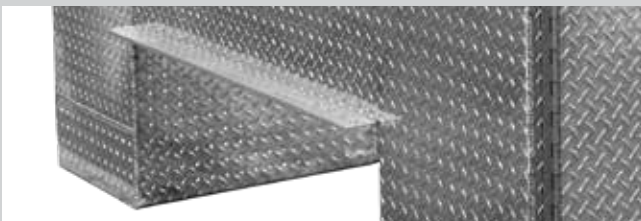

Integral mounting rail for quick and easy installation



Doors open easily with gas powered shocks plus built-in rain gutter with automotive bulb seal

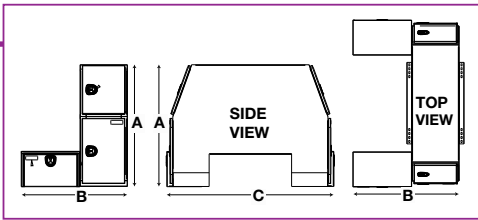

Diamond Tread Aluminum

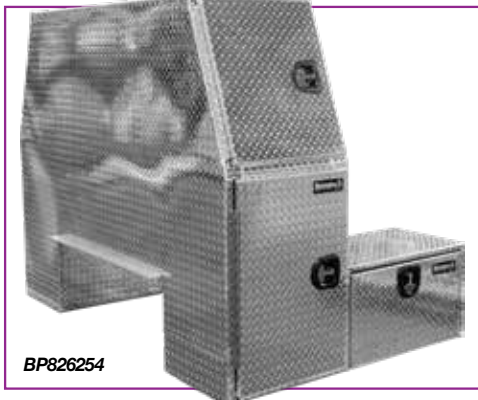

Part No.	Total Height (A)	Depth (C)	Width (B)	Wt. (lb)	Cat.
BP826254	62	54	82	340	592 (Y)
BP827054*	70	54	82	384	592 (Y)

****CAUTION:** Failure to use supplied mounting kit may void warranty on Aluminum Backpack Boxes

Steel, Black Powder-Coated



Part No.	Total Height (A)	Depth (C)	Width (B)	Wt. (lb)	Cat.
BP855548B*	55	54	82	638	592 (Y)

Steel, White Powder-Coated



Part No.	Total Height (A)	Depth (C)	Width (B)	Wt. (lb)	Cat.
BP855548W*	55	54	82	638	592 (Y)

Underbody Boxes

DIAMOND TREAD ALUMINUM



- Can be used as bolt-on or weld-on underbodies with any backpack box
- Durable, corrosion-resistant, .100" thick aluminum diamond tread
- Locking die-cast T-handle compression latch

CARBON STEEL



- Can be used as bolt-on underbodies with any backpack box
- 14 gauge powder-coated steel box with 12 gauge steel door
- Locking stainless steel T-handle latch

Common Features



Manufactured by a talented workforce in Northeast Ohio



Drop-down recessed door



Aluminum bolt-on continuous hidden hinge and replaceable gasket sealing system

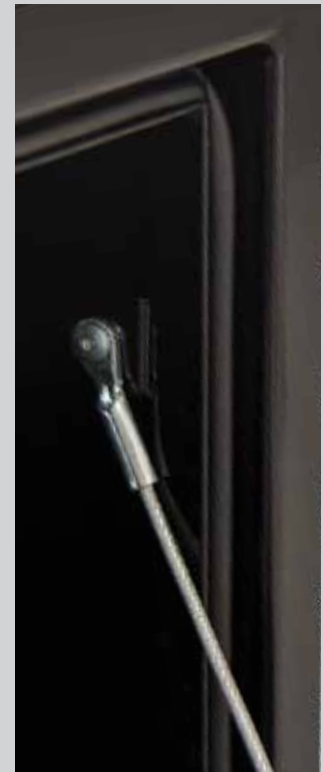

Aircraft grade door cables

Diamond Tread Aluminum



Part No.	Total Height	Depth	Width	Wt. (lb)	Cat.
BP141624	14	16	24	18	530

Steel, Black Powder-Coated



Part No.	Total Height	Depth	Width	Wt. (lb)	Cat.
1703300	14	16	25	46	530
1703303	14	16	30	55	530
1703304*	14	16	30	72	530

*Includes built-in shelf

Steel, White Powder-Coated



Part No.	Total Height	Depth	Width	Wt. (lb)	Cat.
1703400	14	16	24	46	530
1703403	14	16	30	55	530
1703404*	14	16	30	72	530

*Includes built-in shelf

Steel, Primed Powder-Coated



Part No.	Total Height	Depth	Width	Wt. (lb)	Cat.
1703900	14	16	24	46	530

Accessories

STEEL AND ALUMINUM BACKPACK ACCESSORIES

Universal Spring Cushion Mounting Kit

- Provides flex to reduce strain on steel and aluminum backpack truck boxes
- Ideal for off-road applications
- 5/8" U-bolts with forged tie bars, springs and fasteners (all zinc plated)
- Included with all aluminum backpacks

- ⚠ **CAUTION:** Failure to use supplied mounting kit may void warranty on aluminum backpack boxes
- Additional sizes available as custom orders

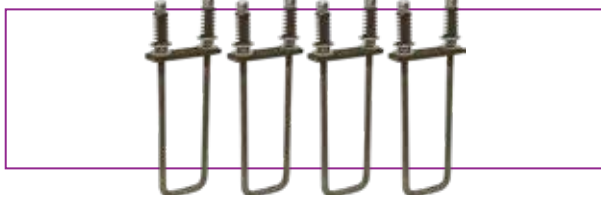

Part No.	Description	Wt. (lb)	Cat.
3008086	Universal Spring Cushion Mounting Kit	17	531 (Y)

Universal Square Bend U-Bolt Kit

- Secure truck boxes to truck body, or connect body to truck chassis
- 5/8" U-Bolts with fasteners and forged tie bars
- Durable Grade 5 hardware
- Additional sizes available as custom orders

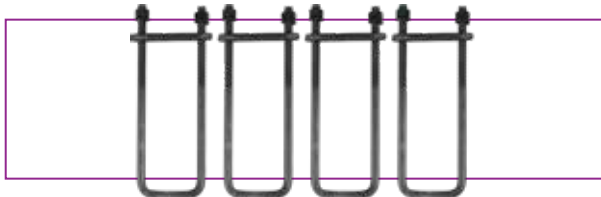

Part No.	Description	Wt. (lb)	Cat.
UB623516	Universal Mounting Kit	17	531 (Y)

Backpack Mounting Adapter

- Provides a level base with a pre-fabricated kit that ensures optimal fit and reduced installation time
- Black powder-coated bracket and zinc plated hardware add corrosion resistance
- Recommended for use with all Ford® 2017+ applications

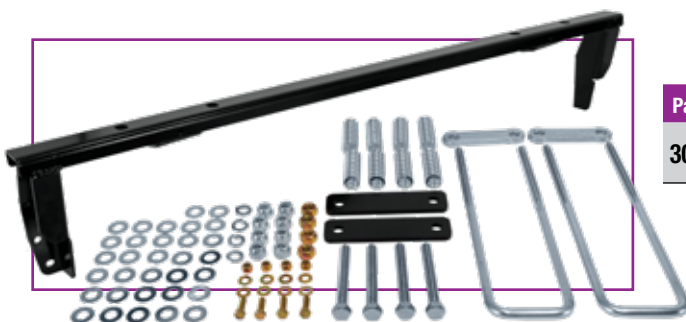

Part No.	Description	Wt. (lb)	Cat.
3037014	Backpack Mounting Adapter for Ford 2017+	47.24	531 (Y)

J-Hook Hanger

- Universal J-hook hangers for holding items like chains or straps
- Bolt-on or weld-on
- Folding zinc plated J-hooks swing flush with compartment walls when not in use
- Hanger 3009122 comes installed inside every box*



*Excludes BP964824BLL and BP964824WLL due to full-length shelving.

Part No.	Description	Wt. (lb)	Cat.
3009122	Double J-Hook with Steel Mounting Angle	0.85	530-1 (N)
3009938	Triple J-Hook with Aluminum Mounting Angle	2.16	530-1 (N)

LED Strip Light with 3M®** Adhesive Back



- Flexible strip lights can be mounted nearly anywhere extra light is needed. Ideal for tool boxes, truck beds, storage boxes, and trunk areas
- Each strip has a blunt cut connection on both ends and can be cut to length every three LEDs
- IP67 rated for water and dust resistance and backed with a 5 year warranty
- Includes end caps and mounting clips
- Separate 17.5" mounting channel also available

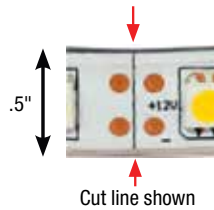

Part No.	Size	LED's	Amps	Lumens	Color	Connection	Std. Qty.	Wt. (lbs.)	Cat.
5621827	18"	27	0.41	360	Clear, Warm	Blunt Cut, Both Ends	1	0.31	562 (N)
5621928	18"	27	0.41	360	Clear, Cool	Blunt Cut, Both Ends	1	0.31	562 (N)
5622436	24"	36	0.54	470	Clear, Warm	Blunt Cut, Both Ends	1	0.35	562 (N)
5622537	24"	36	0.54	470	Clear, Cool	Blunt Cut, Both Ends	1	0.35	562 (N)
5623654	36"	54	0.81	710	Clear, Warm	Blunt Cut, Both Ends	1	0.40	562 (N)
5623755	36"	54	0.81	710	Clear, Cool	Blunt Cut, Both Ends	1	0.40	562 (N)
5624872	48"	72	1.12	940	Clear, Warm	Blunt Cut, Both Ends	1	0.44	562 (N)
5624973	48"	72	1.12	940	Clear, Cool	Blunt Cut, Both Ends	1	0.44	562 (N)
5626090	60"	90	1.30	1180	Clear, Warm	Blunt Cut, Both Ends	1	0.55	562 (N)
5626191	60"	90	1.30	1175	Clear, Cool	Blunt Cut, Both Ends	1	0.55	562 (N)
56296144	96"	144	2.00	2160	Clear, Warm	Blunt Cut, Both Ends	1	0.88	562 (N)
56297145	96"	144	2.00	2160	Clear, Cool	Blunt Cut, Both Ends	1	0.88	562 (N)
562109166	108"	165	3.00	2400	Clear, Cool	Blunt Cut, Both Ends	1	1.12	562 (N)
562133202	132"	201	4.00	3000	Clear, Cool	Blunt Cut, Both Ends	1	1.37	562 (N)

LED Strip Light Mounting Channel



3035896 shown with cool temperature strip

Part No.	Length	Color	Mounting	Cat.
3035896	17-1/2"	Black	3M®** Tape	562 (N)

**3M® is a registered trademark of 3M Company



IN-BED STORAGE



STORAGE

Crossover Truck Boxes

NEW DESIGN

Corrosion resistant diamond tread aluminum construction

Weather resistant seals keep moisture and dirt out of the tool box

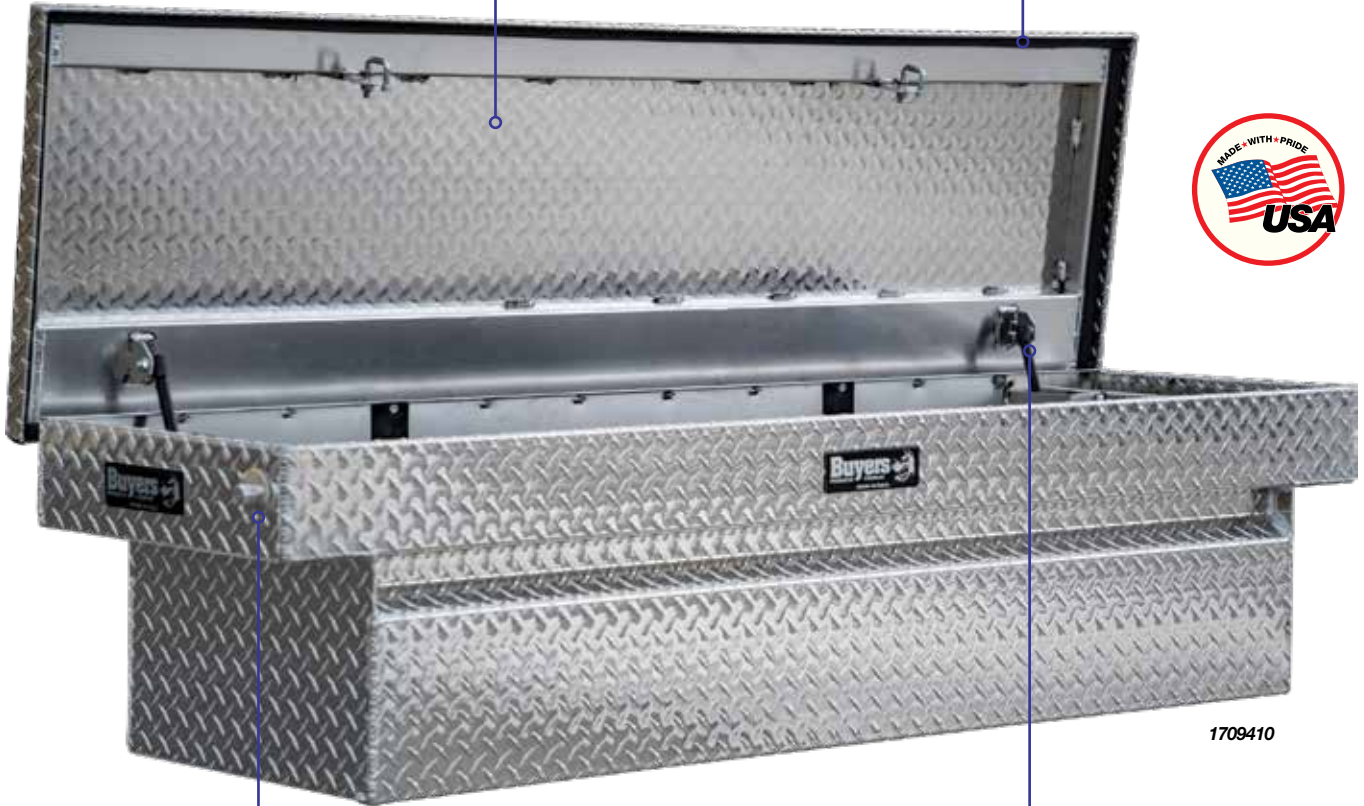

1709410

Stainless steel push-button locks open from either side

Easy-open lid with 2 gas shocks opens a full 90 degrees and closes with a light touch

Crossover Features

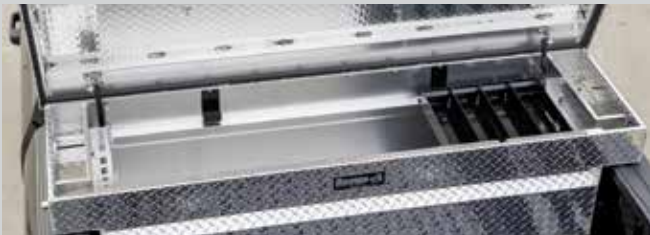

Lockable tray and integrated tool holders make it easy to stay organized



Stainless steel push-button locks



Fully concealed aluminum continuous hinge

SINGLE LID WITH PUSH-BUTTON LOCK

- Fits full size and compact pickup trucks
- Gas shock props lid open
- Stainless steel push-button locks open from either side
- Suspends from pickup side rails
- Includes mounting hardware
- Locking tool tray with removable dividers
- Pre-drilled mounting holes and included hardware make installation easy

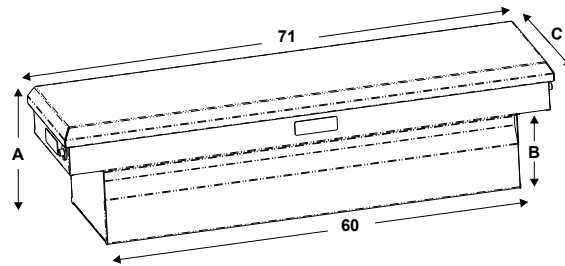
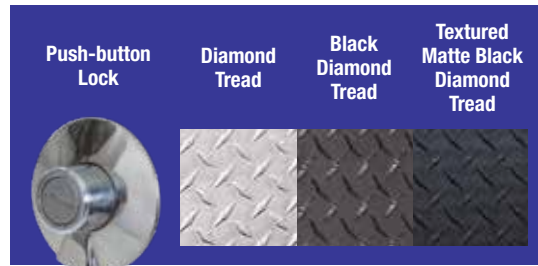

Diamond Tread



Part No.	Height (A/B)	Depth (C)	Width	Cubic ft.	Wt. (lb)	Cat.
1709410*	18/11	20	71/60	11.1	75	530 (Y)
1709415*	23/16	20	71/60	14.2	81	530 (Y)
1709420*	18/11	27	71/60	15.1	89	530 (Y)
1709425**	23/16	27	71/60	19.1	94	530 (Y)
1709430*	13/6	20	63/54	8.8	63	530 (Y)

Black Diamond Tread



Part No.	Height (A/B)	Depth (C)	Width	Cubic ft.	Wt. (lb)	Cat.
1729410*	18/11	20	71/60	11.1	75	530 (Y)
1729415*	23/16	20	71/60	14.2	77	530 (Y)
1729420*	18/11	27	71/60	15.1	89	530 (Y)
1729425**	23/16	27	71/60	19.1	91	530 (Y)
1729430*	13/6	20	63/54	8.8	63	530 (Y)

Textured Matte Black Diamond Tread



Part No.	Height (A/B)	Depth (C)	Width	Cubic ft.	Wt. (lb)	Cat.
1739410*	18/11	20	71/60	11.1	75	530 (Y)
1739420*	18/11	27	71/60	15	89	530 (Y)
1739415*	23/16	20	71/60	14.2	81	530 (Y)
1739425**	23/16	27	71/60	19	94	530 (Y)
1739430*	13/6	20	63/54	8.8	63	530 (Y)

**Works in beds with slants

Crossover

GULL WING WITH PUSH-BUTTON LOCK

- .100" thick diamond tread aluminum
- Double-sided lids with gas shocks
- Two stainless steel one-touch push-button locks
- Reinforced rib design
- Includes tray and dividers
- Suspends from pickup side rails with included J-Hooks
- Fits full size pickups with 6-1/2' and 8' beds
- Includes mounting hardware

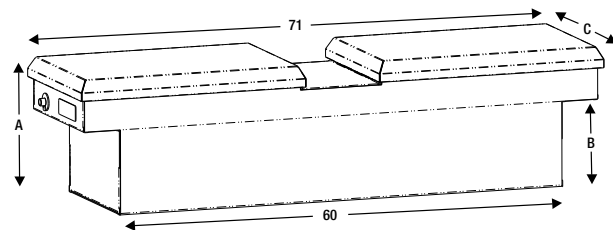
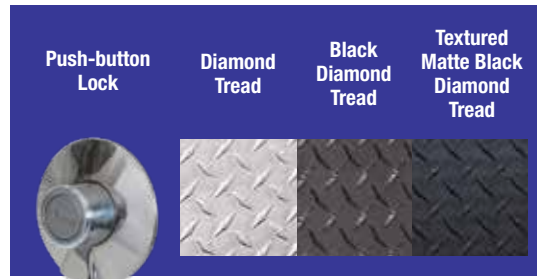

Diamond Tread



Part No.	Height (A/B)	Depth (C)	Width	Cubic ft.	Wt. (lb)	Cat.
1710305	18/11	20	71/60	11.1	67	530 (Y)
1710308	23/16	20	71/60	14.2	73	530 (Y)
1710315	18/11	27	71/60	15.1	81	530 (Y)
1710318*	23/16	27	71/60	19.1	85	530 (Y)

*Works in beds with slants

Black Diamond Tread



Part No.	Height (A/B)	Depth (C)	Width	Cubic ft.	Wt. (lb)	Cat.
1720305	18/11	20	71/60	11.1	67	530 (Y)
1720308	23/16	20	71/60	14.2	73	530 (Y)
1720315	18/11	27	71/60	15.1	81	530 (Y)
1720318*	23/16	27	71/60	19.1	85	530 (Y)

*Works in beds with slants

Textured Matte Black Diamond Tread



Part No.	Height (A/B)	Depth (C)	Width	Cubic ft.	Wt. (lb)	Cat.
1722305	18/11	20	71	11.1	67	530 (Y)

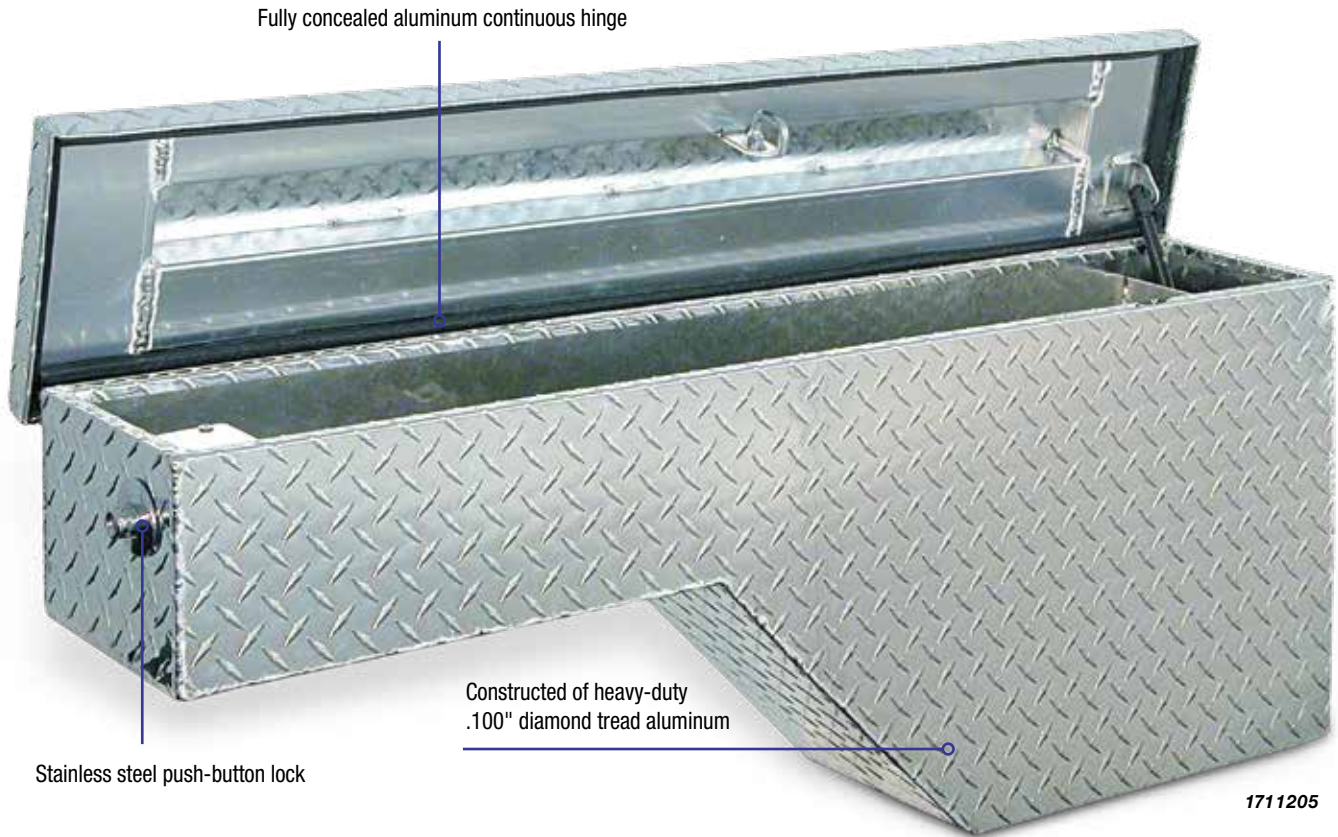

WHEEL WELL WITH PUSH-BUTTON LOCK

- .100" thick aluminum diamond tread aluminum
- Lid features gas shock and one-touch stainless steel push-button rotary locking mechanism
- Low profile over-the-wheel mounting offers convenient storage while maximizing pickup truck bed space
- Fits most pickups
- May also be mounted in front of wheel wells on full-size long bed pickups

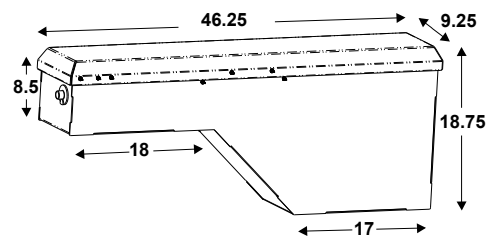
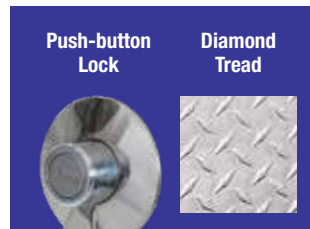

Diamond Tread



Part No.	Description	Height	Depth	Width	Wt. (lb)	Cat.
1711205	Driver Side Rear/	18.75/	9.25	46.25/	26	530
	Passenger Side Front	8.5				
1711206	Passenger Side Rear/	18.75/	9.25	46.25/	26	530
	Driver Side Front	8.5				

Lo-Sider Truck Boxes

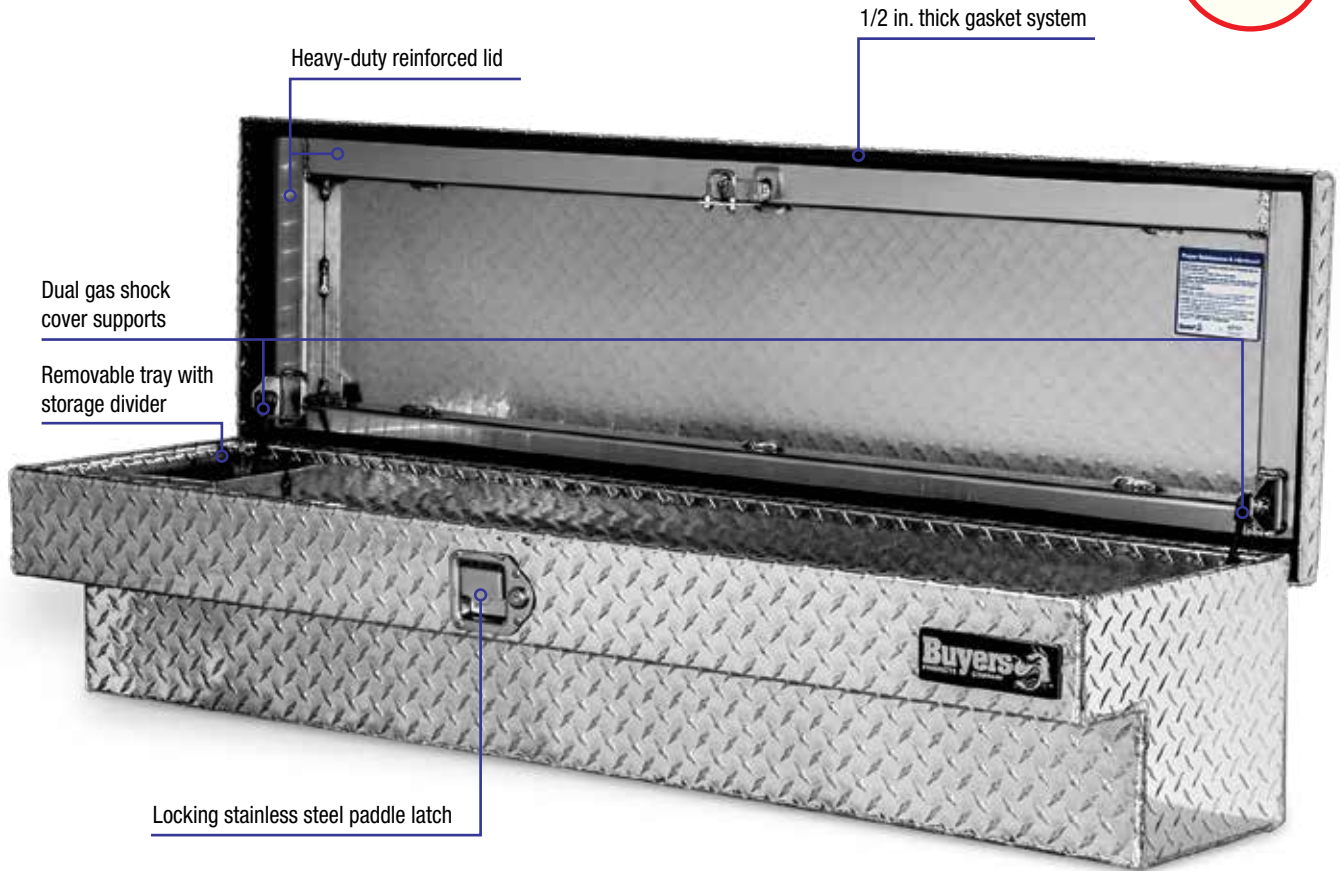

1711020

Lo-Sider/Rail Features



Removable tray with storage divider



The cover support housing protects the gas shocks



Locking stainless steel paddle latch



Full weather stripping keeps dust and moisture out

LO-SIDER WITH PADDLE LATCH

- .056" thick diamond tread
- Mounts along bed rail of pickups
- Locking stainless steel paddle latch
- Aluminum hinge is welded to the lid and bolted to the box
- Includes tray and dividers
- Mounting hardware included
- Fits full size pickups with 6-1/2' and 8' beds

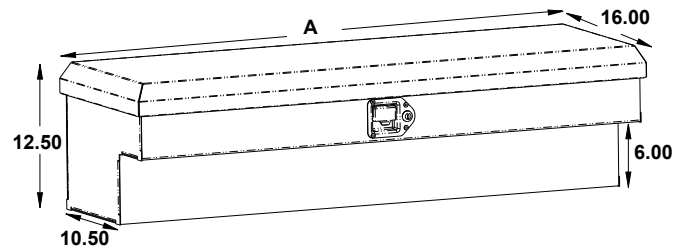

Diamond Tread



Part No.	Height	Depth	Width (A)	Cubic ft.	Wt. (lb)	Cat.
1711010	12.5	10.5	16	47	3.4	23 530 (Y)
1711020	12.5	10.5	16	56	4.0	47 530 (Y)
1711025	12.5	10.5	16	70	5.2	52 530 (Y)
1711030	12.5	10.5	16	87	6.3	63 530 (Y)

Black Diamond Tread



Part No.	Height	Depth	Width (A)	Cubic ft.	Wt. (lb)	Cat.
1721010	12.5	10.5	16	47	3.4	23 530 (Y)
1721020	12.5	10.5	16	56	4.0	47 530 (Y)
1721025	12.5	10.5	16	70	5.2	52 530 (Y)
1721030	12.5	10.5	16	87	6.3	63 530 (Y)

Textured Matte Black Diamond Tread



Part No.	Height	Depth	Width (A)	Cubic ft.	Wt. (lb)	Cat.
1731020	12.5	10.5	16	56	4.0	47 530 (Y)

Storage Chests

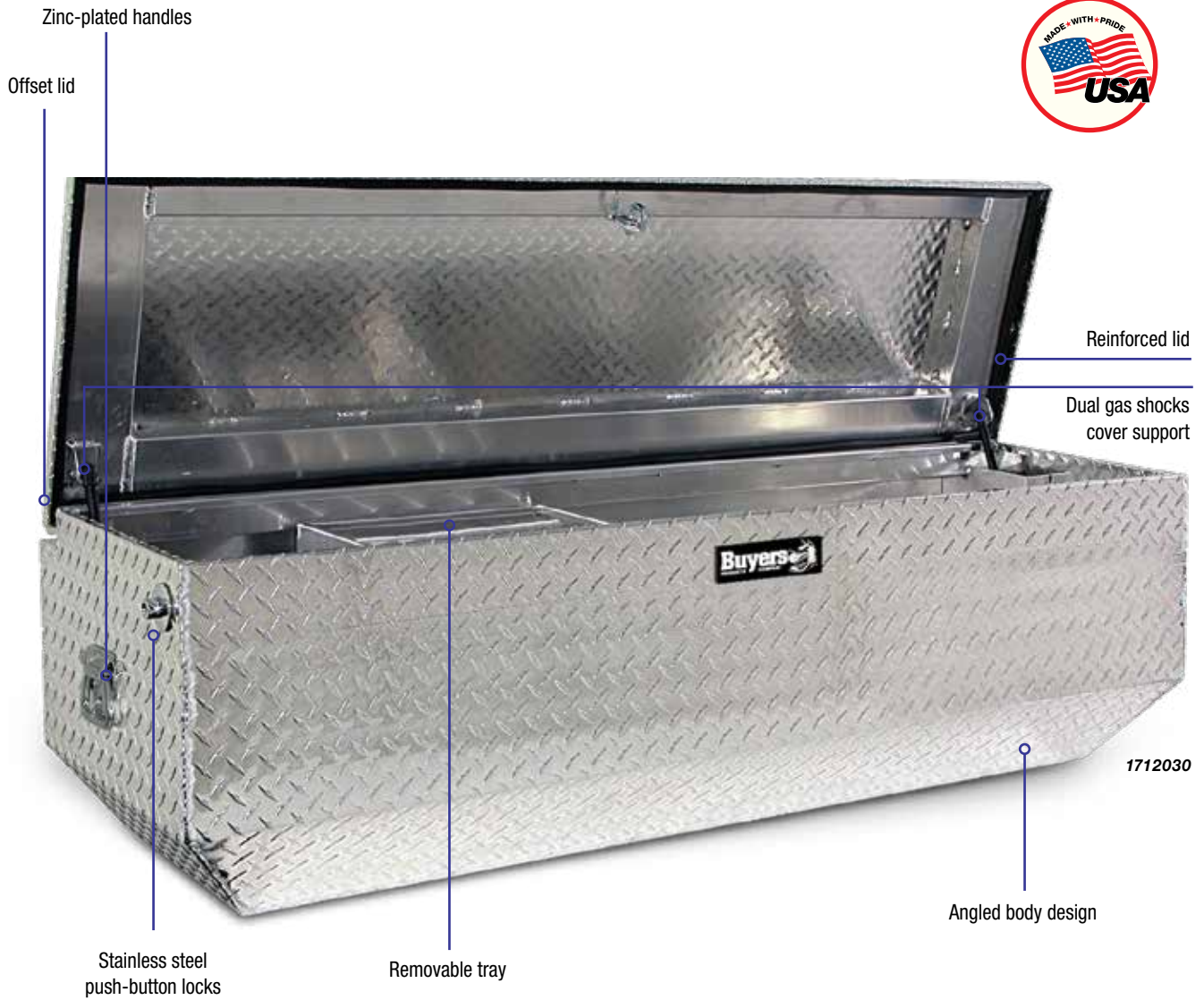

Storage Chest Features



Gas shock cover support protects shocks from damage.



Two zinc-plated handles for easy lifting.



Reinforced lid for extra durability.



Angled body design is ideal for use with fifth wheel and goose-neck trailer applications.

ANGLED BASE WITH PUSH-BUTTON LOCK

- .056" thick diamond tread
- Stainless steel one-touch push-button locks
- Continuous aluminum hinge is welded to the lid and bolted to the box
- Offset lid allows for 90° opening when placed against truck bed
- Door assisting gas shocks
- Angled body for use with fifth wheel or gooseneck trailer application
- Includes tray and dividers



Part No.	Height	Depth	Width (A/B)	Cubic ft.	Wt. (lb)	Cat.
1712010†	18.5	20/15	47/47	10	52.5	530 (Y)
1712020†	18.5	20/15	55/54	12	55	530 (Y)
1712030††	19	20/16	60/52	12.5	60	530 (Y)
1712035††	19	27/27	60/52	18	74	530 (Y)

†Boxes have angled base on front only

††Boxes have angled base on front and sides

Textured Matte Black



Part No.	Height	Depth	Width (A/B)	Cubic ft.	Wt. (lb)	Cat.
1722010†	18.5	20/15	47/47	10	52.5	530 (Y)

†Boxes have angled base on front only

JUMBO CHEST WITH PADDLE LATCH

- .100" thick diamond tread
- Locking stainless steel paddle latch
- Continuous aluminum hinge is welded to the lid and bolted to the box
- Zinc plated handles

Diamond Tread Aluminum



Part No.	Height	Depth	Width	Cubic ft.	Wt. (lb)	Cat.
1712110	24	24/22	49	15	73.5	530 (Y)
1712120	30	30/28	49	24	92	530 (Y)

Storage Chests

POLY CHEST WITH HASP

- Lightweight, dent-resistant, high-density polyethylene body
- Box contents stay safe and secure behind a molded, double-wall, stainless steel hinged lid
- Corrosion and weather resistant stainless steel hasp and hinge made for use with combination lock or padlock (lock sold separately)
- Mount to floor of pickup beds, trailers or for use in garages



Black, Single Hasp



Part No.	# Hasps	Height	Depth	Width	Cubic ft.	Wt. (lb)	Cat.
1712230	1	13.5	15/9.25	32/29.5	2.6	16	530 (Y)
1712250	1	22.5	19.5/18.75	51/47	8.4	34	530 (Y)

Black, Dual Hasp



Part No.	# Hasps	Height	Depth	Width	Cubic ft.	Wt. (lb)	Cat.
1712240	2	17.25	19/13.25	44/41.25	6.3	28	530 (Y)
1712255	2	26	23/21	51/47.25	17	46	530 (Y)
1712260	2	23	25/19	77/73	18.8	52	530 (Y)

POLY CHEST WITH 2" RECEIVER MOUNT

- Durable, lightweight high density polyethylene construction
- Fully enclosed, water resistant design
- Mounts in 2" hitch receivers to provide portable, accessible storage
- Great for camping, fishing, tailgating, and more
- 17 cubic feet of functional space
- Holds up to 300 pounds
- Double walled lid with two lockable hasps (padlocks sold separately)
- Steel frame with black powder-coated finish
- Comes pre-drilled for easy assembly and installation
- Comes with all hardware including 5/8in. hitch pin



Part No.	# Hasps	Height	Depth	Width	Cubic ft.	Wt. (lb)	Cat.
1707020*	2	26	23/21	51/47.25	17	76	530 (Y)



HEAVY DUTY POLY STORAGE BINS

- Constructed from durable and rust-proof polyethylene for years of use
- Double panel sloped lid provides a weather-resistant barrier to keep contents dry
- Molded hand holds and fork lift slots allow for easy lifting and carrying
- Ideal for storing dry, loose materials like rock salt, grain, sand, seed or litter
- Suitable for indoor or outdoor use

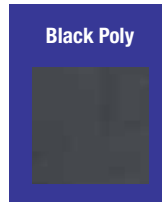

Black, 20" High



Part No.	Height	Depth	Width	Wt. (lb)	Cat.
9031105	20	24	36	21	903-1 (N)

SHIPS UPS!

Black, 30" High



Part No.	Height	Depth	Width	Wt. (lb)	Cat.
9031100	30	24	36	28	903-1 (N)

Material Scoop



Part No.	Height	Depth	Width	Wt. (lb)	Cat.
9031110	Material Scoop			2.47	903-1 (N)



Slide Out Truck Bed Boxes

NEW DESIGN

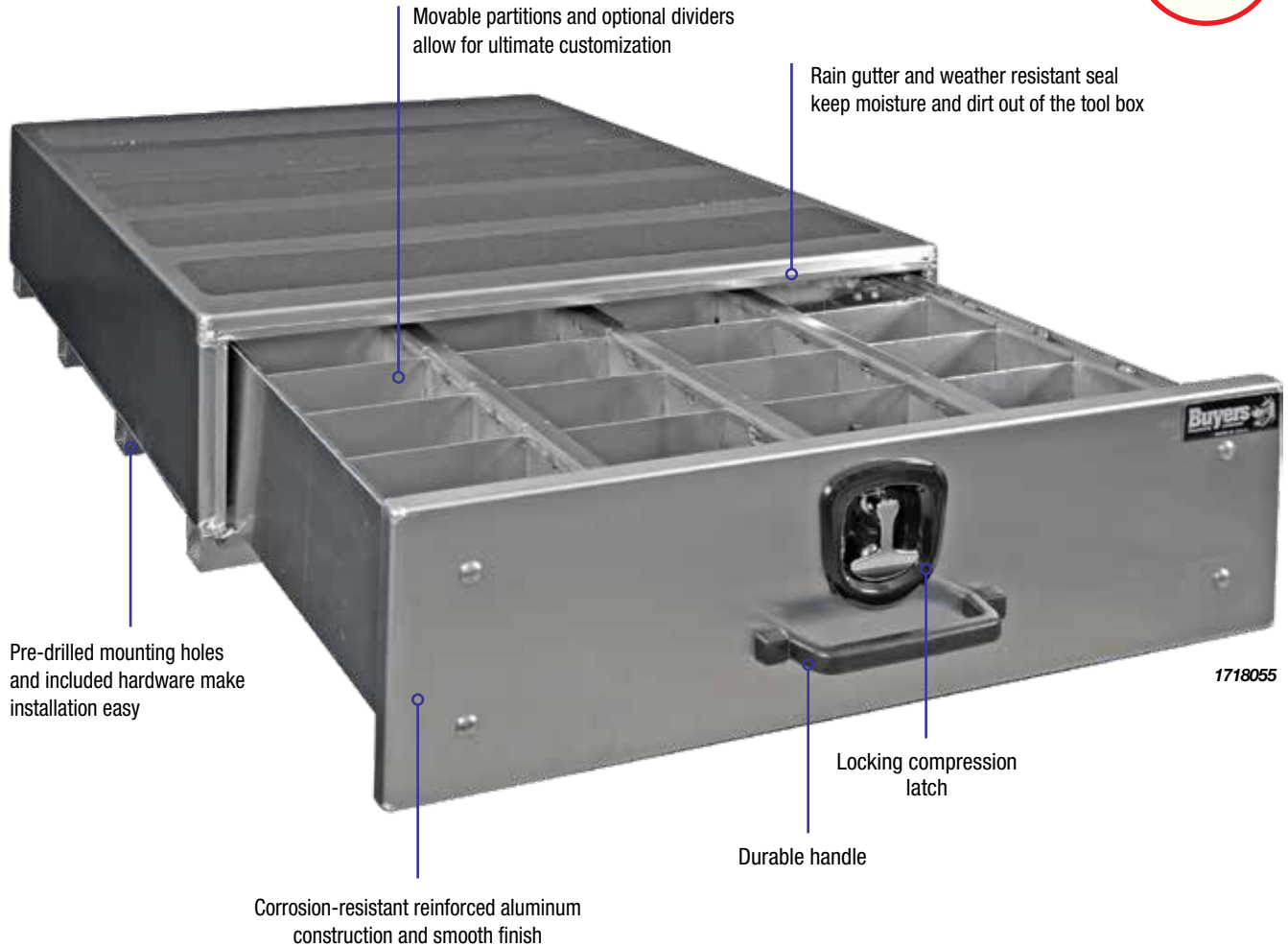

Slide Out Box Features



Installs in the bed of your truck or in cargo van for easy slide-out access to tools



Removable partitions and optional dividers (sold separately) can be positioned to accommodate your storage needs



Locking die cast compression handle keeps tools safe and secure

SLIDE OUT TRUCK BOX WITH COMPRESSION LATCH

- 500 lb capacity drawers and 800 lb top load (evenly distributed)
- Heavy duty reinforced aluminum box and drawer construction
- Removable partitions to accommodate tools and hardware
- Full door gasket and rain gutter
- Mounting hardware and dividers included
- Additional divider kits also available

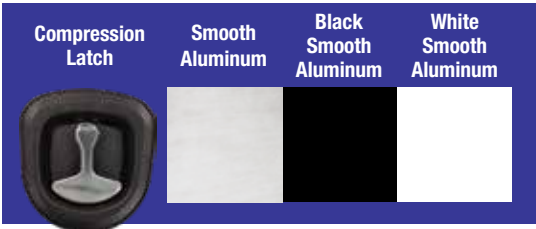

Smooth Aluminum



1718050, 1718060 shown

Part No.	Height	Depth	Width	Cubic Ft.	Wt. (lbs.)	Cat.
1718050*	9	48	20	3.54	78	895 (Y)
1718055*	9	48	40	7.08	130	895 (Y)
1718060*	12	24	40	4.87	90	895 (Y)
1718065*	12	48	20	4.79	92	895 (Y)
1718070*	12	48	40	10.11	150	895 (Y)

Black Smooth Aluminum



1718350, 1718360 shown

Part No.	Height	Depth	Width	Cubic Ft.	Wt. (lbs.)	Cat.
1718350*	9	48	20	3.54	78	895 (Y)
1718355*	9	48	40	7.08	130	895 (Y)
1718360*	12	24	40	4.87	90	895 (Y)
1718365*	12	48	20	4.79	92	895 (Y)
1718370*	12	48	40	10.11	150	895 (Y)

White Smooth Aluminum



1718450, 1718460 shown

Part No.	Height	Depth	Width	Cubic Ft.	Wt. (lbs.)	Cat.
1718450*	9	48	20	3.54	78	895 (Y)
1718455*	9	48	40	7.08	130	895 (Y)
1718460*	12	24	40	4.87	90	895 (Y)
1718465*	12	48	20	4.79	92	895 (Y)
1718470*	12	48	40	10.11	150	895 (Y)

Divider Kit for Bed Boxes



Part No.	Description	Cat.
3036255	Works with 9 x 48 x 40 sizes	591
3036256	Works with 12 x 24 x 40 sizes	591
3036257	Works with 12 x 48 x 40 sizes	591

* **NEW** PRODUCTS

Trailer Tongues

STEEL TRAILER TONGUE WITH HASP

- 14 gauge steel box with 12 gauge steel door
- Locking stainless steel paddle latch
- Stainless steel continuous hidden hinge
- Designed to mount to the front of A-frame style trailers

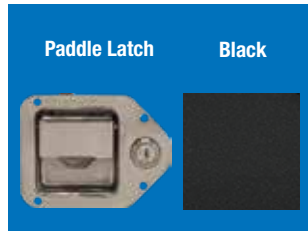

Black

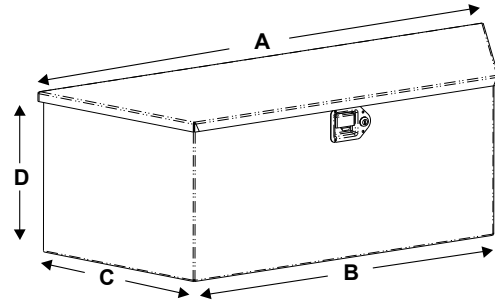

Part No.	Height (D)	Depth (C)	Width (A/B)	Wt. (lb)	Cat.
1701280	15	14.5	34/22.5	51	530 (Y)
1701281	12	13.25	26/14	33	530 (Y)
1701285	18.5	15	49/37	74	530 (Y)

ALUMINUM TRAILER TONGUE WITH PADDLE LATCH

- .056 thick diamond tread aluminum
- Locking stainless steel paddle latch
- Aluminum continuous hidden hinge
- Designed to mount to the front of A-frame style trailers



Diamond Tread



Part No.	Height (D)	Depth (C)	Width (A/B)	Wt. (lb)	Cat.
1701380	15	14.5	34/20.7	17.5	530 (Y)
1701385	18.5	15	49/37	28	530 (Y)

POLY TRAILER TONGUE WITH HASP

- Constructed of high-density polyethylene
- Designed to mount to the front of A-frame style trailers
- Corrosion and weather resistant stainless steel hasp and hinge made for use with combination lock or padlock (lock sold separately)

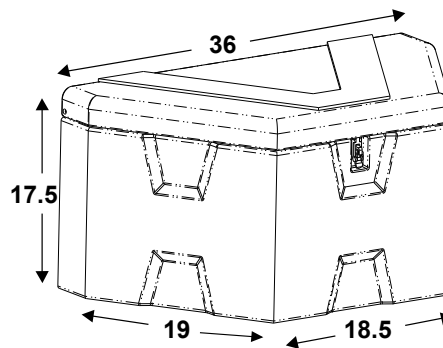
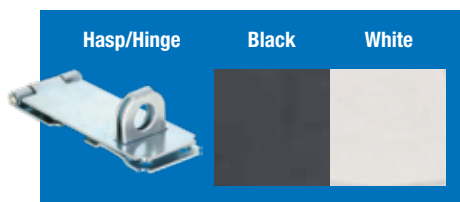

Black



Part No.	Height	Depth	Width	Cubic ft.	Wt. (lb)	Cat.
1701680	18	19	36/ 8	5.34	21	530 (Y)

White



Part No.	Height	Depth	Width	Cubic ft.	Wt. (lb)	Cat.
1701679	18	19	36/18	5.34	21	530 (Y)

Class 8 Boxes

NEW!



WideOpen™ Box Features



Die cast compression latch with covered key assembly



Non-slip (grip strut) steps and stainless steel continuous hidden hinge

WIDEOPEN™ STEP BOXES

- Provides frame steps with built-in storage space
- Non-slip (grip strut) steps
- .125" smooth aluminum construction
- D-bulb door seal protects from the elements
- Locking die-cast T-handle compression latch
- Stainless steel continuous hidden hinge
- Corner gussets on door opening provide extra strength
- 1/8" thick integral corner braces provide mounting support
- For heavy loads and toolboxes wider than 18", #1701015 steel mounting brackets are recommended to prevent stress cracks



Part No.	Height	Depth	Width	Wt. (lb)	Cat.
1705280*	24	28	12	40	530 (Y)
1705281*	24	28	18	47	530 (Y)
1705282*	24	28	24	56	530 (Y)
1705283*	24	28	30	64	530 (Y)
1705284*	24	28	36	76	530 (Y)
1705285*	24	28	16	45	530 (Y)
1705286*	24	28	22	51	530 (Y)

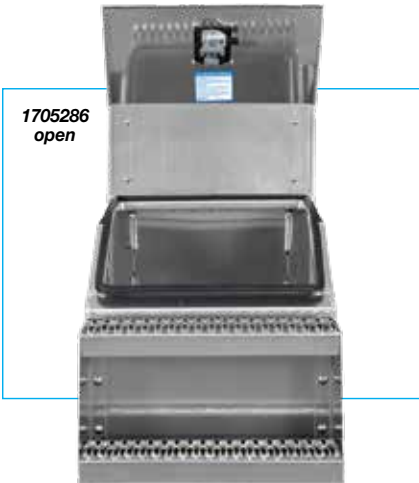

Class 8 Boxes

STEP BOXES

- Provides frame steps with built-in storage space
- Non-slip (grip punch) steps
- .125" smooth aluminum body
- .100" diamond tread aluminum door
- D-bulb door seal protects from the elements
- Locking die-cast T-handle compression latch
- Stainless steel continuous hidden hinge
- Corner gussets on door opening provide extra strength
- 1/8" thick integral corner braces provide mounting support
(for heavy loads and toolboxes wider than 18", #1701015 steel mounting brackets are recommended to prevent stress cracks)

Diamond Tread Aluminum



Part No.	Height	Depth	Width	Wt. (lb)	Cat.
1705180	24	28	12	40	530 (Y)
1705181	24	28	18	46	530 (Y)
1705182	24	28	24	56	530 (Y)
1705183	24	28	30	66	530 (Y)

FRAME STEPS

- Grip strut tread increases step-on traction
- Heavy duty aluminum construction
- .188" smooth aluminum sides
- Easy installation

Smooth Aluminum

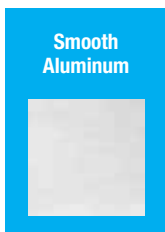

Part No.	Height	Depth	Width	Wt. (lb)	Cat.
5239012*	24	28	12	12	523 (Y)
5239018*	24	28	18	13	523 (Y)
5239024*	24	28	24	14	523 (Y)

IN-FRAME BOXES

- Body constructed of .100" smooth aluminum
- .100" Diamond tread aluminum lid with inner bracing
- Full width stainless steel hinge
- Rain gutter and D-bulb seals
- TIG Welded
- Mounts between truck frame rails
- Corrosion and weather resistant stainless steel hasp and hinge made for use with combination lock or padlock (lock sold separately)
- Replaceable gasket sealing system



Diamond Tread Aluminum



Part No.	Height	Depth	Width	Wt. (lb)	Cat.
1705190	9	22	30	32	530 (Y)

CHAIN HOLDER

- Constructed of structural steel with aluminum diamond tread cover
- TIG welded
- Pre-drilled mounting holes
- Hinged diamond plate cover comes with lock hasp for secure use
- Keeps tire chains securely in place



Diamond Tread Aluminum



Part No.	Height	Depth	Width	Wt. (lb)	Cat.
5910024	9	7.5	24	34	591 (N)

Parts & Accessories

Die Cast Compression Latch



- Strong, secure compression operation
- Latch is secure and stays shut with the adjustable cam action roller engagement
- Helps keep dirt, grime, and dust out of your box
- Corrosion-resistant powder-coated housing
- Corrosion-resistant chrome plated T-handle
- Adjustable cam, from .850 in. to 1.320 in. (No tools required for adjustment)

***Replacement for Buyers boxes using L8816 and L3890RLS latch**

Part No.	Description	Wt. (lbs.)	Cat.
LL9000	Single Point, Compression Latch with Blind Studs, 1/2" Gasket and Cylinder with keys included	2.04	510 (N)
LL90003	3-Point, Compression Latch with Blind Studs, 1/2" Gasket and Cylinder with keys included	2.04	510 (N)

Heavy-Duty Standard Size Flush Mount Folding T-handle Latches



Part No.	Description	Wt. (lbs.)	Cat.
L882502	3/4" Replacement Rods for 2 and 3 point latches	105	510 (N)

- Polished Stainless steel
- Available in single, double or triple point contact to address most applications
- Adjustable cam from 1.25" to 2" to accommodate door thicknesses
- Designed to mount into a 3.75" x 4" recess opening.
(L8816 fits into 4.375" x 3.5" recess opening)

Part No.	Description	Wt. (lbs.)	Cat.
L8815	Stainless Steel T-Handle Latch with Mounting Holes, Cylinder & Keys Included	1.25	510 (N)
L8816	Tall Flush Mount T-Handle Latch with Blind Studs, Cylinder & Keys Included	1.50	510 (N)
L8915	Zinc Plated Stainless Steel T-Handle Latch with Mounting Holes, Cylinder & Keys Included	1.25	510 (N)
L8825	Standard Size 2 Point T-Handle Latch with Mounting Holes, Cylinder & Keys Included	2.50	510 (N)
L8835	Standard Size 3 Point T-Handle Latch with Mounting Holes, Cylinder & Keys Included	2.75	510 (N)
L8855	Standard Size Flush Mount T-Handle Latch with Blind Studs, Cylinder & Keys Included	1.26	510 (N)
L8815G0	Replacement Gasket For L8815, L8855, and L8915	0.01	510 (N)

Poly Underbody Replacement Latch

- Polished Stainless steel
- 3-Point latch
- Adjustable cam from 0.25" to 1.6"
- Designed to mount into a 4-3/8" x 3-1/2" recess opening

***Replacement for Buyers poly underbody boxes only, not compatible with standard underbody toolboxes**



Part No.	Description	Wt. (lbs.)	Cat.
L882502	3/4" Replacement Rods for 2 and 3 point latches	105	510 (N)

Part No.	Description	Wt. (lbs.)	Cat.
L8816R	3-Point Latch Folding-T Handle, with Roller	1.43	510 (N)

Mini Size Tear Drop Latch

- Ideal for use on toolboxes and other small compartment doors
- Polished stainless steel finish
- Locking version includes cylinder and two keys



Part No.	Description	Face Dims. (HxW)	Wt. (lbs.)	Cat.
8000SSL	Stainless Steel Mini Size Tear Drop Style Latch (Locking)	4.38" x 3.25"	0.57	510 (N)
8000SSN	Stainless Steel Mini Size Tear Drop Style Latch (Non-Locking)	4.38" x 3.25"	0.55	510 (N)

Standard Size Single-Point Rotary Paddle Latch

- Polished stainless steel
- Hidden studs
- Includes gasket, cylinder and keys
- Includes hasp for alternative lock. Requires 7/16" diameter pad lock shank (not included)



Part No.	Description	Face Dims. (HxW)	Wt. (lbs.)	Cat.
L3890RLS	Stainless Steel Rotary Single Point Paddle Latch, 1/4" Striker	5.5" x 4.75"	1.40	510 (N)
3005833	Striker Plate/Bracket; for use with L3890RLS	-	0.26	530-1 (N)

Cylinder and Key

- For standard and mini size latches
- Various keys available



Part No.	Description	Wt. (lbs.)	Cat.
19CH545	Cylinder and Key	0.09	510 (N)
88CH510	Cylinder Lock with 2 Keys	0.13	510 (N)
39LL71	Cylinder and Key	0.09	510 (N)
L38RLSCH545	Cylinder for L3885RLS Latch	0.25	510 (N)
88CH545	Cylinder for L8815/L8915/L8816 Latch	0.25	510 (N)
CDC01Z	Zinc Die Cast Cylinder Dust Cover (Works with all Cylinders and Keys Listed Above)	0.05	510 (N)

Push Button Lock and Key

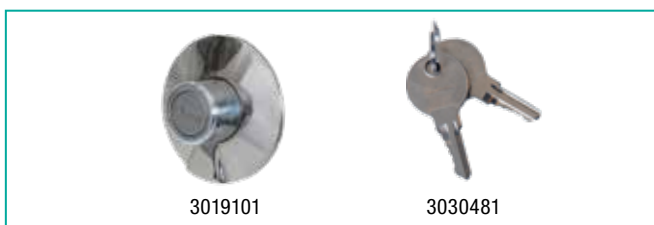

Part No.	Description	Wt. (lbs.)	Cat.
3019101	Push Button Lock with Key	0.68	530-1 (N)
3030481	Spare Keys for Push Button Lock	0.03	530-1 (N)

Parts & Accessories

Replacement Tray for 2020+ Crossover Truck Tool Boxes

- Oversized powder-coated steel tray with dividers
- 3 Dividers are removable for flexible storage
- For use with the newly redesigned cross body tool boxes (page 63)



Part No.	Depth (in)	Width (in)	Wt. (lbs.)	Cat.
3043331	15.375	18	7.64	530 (Y)
3047140	15.375	25	10.56	530 (Y)

Gas Shocks

- Dampened extension
- Undampened compression
- Black powder-coated cylinder



Part No.	Extended Length	Compressed Length	Stroke	Rod Diameter	Cylinder Diameter	Ball Socket Diameter	Force Rating (lbs.)	Wt. (lbs.)	Cat.
3010339	17"	10"	7"	6mm	15mm	10mm	20	0.42	530-1 (N)
3028786	13.93"	8.5"	5.5"	8mm	18mm	10mm	40	0.51	520 (N)
3045508	12"	8"	4"	6mm	15mm	10mm	40	0.27	530-1 (N)
3026586	12"	8"	4"	6mm	15mm	10mm	50	0.42	530-1 (N)
3029916	12"	8"	4"	6mm	15mm	10mm	60	0.27	530-1 (N)
3028392	12"	8"	4"	6mm	15mm	10mm	80	0.42	530-1 (N)
3029917	12"	8"	4"	9.65mm	18.13mm	10mm	100	0.38	530-1 (N)
3022729	12"	8"	4"	6mm	15mm	10mm	25	0.27	530-1 (N)
3023460	19.63"	11.63"	8"	9.98mm	21.59mm	10mm	250	0.85	903-2 (N)
3008745	10mm Ball Stud (Sold Separately except for 3028786)							0.03	530-1 (N)
FNE031018034	Nylock Nut for Ball Stud (Sold Separately except for 3023460)							0.01	530-1 (N)

Dry-Mat Tile

- 3/4" thick, tough automotive grade recycled plastic
- Provides fast evaporation while protecting the surface below
- Maintains original shape and color
- Fast, easy installation

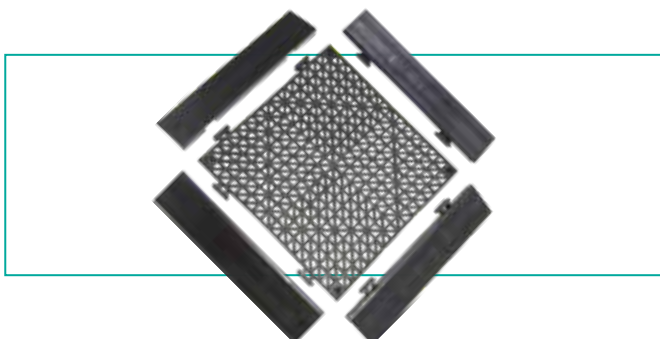

Part No.	Description	Dim	Wt. (lbs.)	Cat.
DM1212B	Tile	12" x 12"	1.42	880 (N)
DM0212BF	Female Edge	2" x 12"	0.33	880 (N)
DM0212BM	Male Edge	2" x 12"	0.35	880 (N)

Trailer Tongue Display Stand



- Works with all Buyers Products Trailer Tongue Tool Boxes
- Contact your Buyers Products sales representative for additional details
- Not intended for use as a retail selling shelf fixture



Part No.	Description	Cat.
3047012	Trailer Tongue Display Stand	994

Underbody Truck Tool Box Display Stand



- Works with all Buyers Products 18x18x36 Underbody Truck boxes
- Contact your Buyers Products sales representative for additional details
- Not intended for use as a retail selling shelf fixture

Part No.	Description	Cat.
99170	Underbody Truck Tool Box Display Stand	994

Underbody Replacement Parts

Part No.	Doors	Latches	Lanyards
1742300	1742300D00R	LL9000	3030806
1742303	1742303D00R	LL9000	3030806
1742305	1742305D00R	LL9000	3030806
1742310	1742310D00R	LL9000	3030806
1742315	1742303D00R	LL9000	3030806
1742325	1742305D00R	LL9000	3030806
1742335	1742335D00R	LL9000	3030806
1742336	1742310D00R	LL9000	3030806
1744300	1744300D00R	LL9000	3041851
1744303	1744303D00R	LL9000	3041851
1744305	1744305D00R	LL9000	3041851
1702295	1702295D00R	L8816	3003081
1702300	1702300D00R	L8816	3003081
1702303	1702303D00R	L8816	3003081
1702305	1702305D00R	L8816	3003081
1702310	1702310D00R	L8816	3003081
1702315	1702315D00R	L8816	3003081
1702317	1702317D00R	L8816	3003081
1702325	1702325D00R	L8816	3003081
1703300	1703300D00R	L8816	3003480
1703303	1703303D00R	L8816	3003480
1703305	1703305D00R	L8816	3003480
1703310	1703310D00R	L8816	3003480
1703312	1703312D00R	L8816	3003480
1703320	1703320D00R	L8816	3003480
1703322	1703322D00R	L8816	3003480
1703324	1703324D00R	L8816	3003480
1703326	1703326D00R	L8816	3003480
1703328	1703328D00R	L8816	3004556
1703330	1703330D00R	L8816	3003480
1703349	1703349D00R	L8816	3003480
1703350	1703350D00R	L8816	3003480
1703353	1703353D00R	L8816R	3003480
1704300	1704300D00R	L8816	3004713
1704303	1704303D00R	L8816	3004713
1704305	1704305D00R	L8816	3004713
1704310	1704310D00R	L8816	3004713
1704315	1704315D00R	L8816	3004713
1708310	1708310D00R	L8816	3003081
1702400	1702400D00R	L8816	3003081
1702403	1702403D00R	L8816	3003081
1702405	1702405D00R	L8816	3003081
1702410	1702410D00R	L8816	3003081
1702415	1702415D00R	L8816	3003081
1702417	1702417D00R	L8816	3003081
1702900	1702900D00R	L8816	3003081
1702905	1702905D00R	L8816	3003081
1702910	1702910D00R	L8816	3003081
1703400	1703400D00R	L8816	3003480
1703403	1703403D00R	L8816	3003480
1703405	1703405D00R	L8816	3003480
1703495	1703495D00R	L3890RLS	3003081
1703900	1703900D00R	L8816	3003480
1704400	1704400D00R	L8816	3004713
1704403	1704403D00R	L8816	3004713

Part No.	Doors	Latches	Lanyards
1704405	1704405D00R	L8816	3004713
1704410	1704410D00R	L8816	3004713
1704415	1704415D00R	L8816	3004713
1708410	1702410D00R	L8816	3003081
1703304	1703303D00R	L8816	3003480
1703351	1703349D00R	L8816	3003480
1703352	1703350D00R	L8816	3003480
1703355	1703303D00R	L8816	3003480
1703404	1703403D00R	L8816	3003480
1702100	1702100D00R	L3890RLS	3003081
1702103	1702103D00R	L3890RLS	3003081
1702105	1702105D00R	L3890RLS	3003081
1702110	1702110D00R	L3890RLS	3003081
1702115	1702115D00R	L3890RLS	3003081
1702200	1702200D00R	L3890RLS	3003081
1702203	1702203D00R	L3890RLS	3003081
1702205	1702205D00R	L3890RLS	3003081
1702210	1702210D00R	L3890RLS	3003081
1702215	1702215D00R	L3890RLS	3003081
1703100	1703100D00R	L3890RLS	3003480
1703103	1703103D00R	L3890RLS	3003480
1703150	1703150D00R	L3890RLS	3003480
1703203	1703203D00R	L3890RLS	3003480
1703205	1703205D00R	L3890RLS	3003480
1702406	-	LL90003	-
1702411	-	LL90003	-
1732300	1732300D00R	LL90003	3024237
1732303	1703203D00R	L3890RLS	3003480
1732305	1732305D00R	LL90003	3024237
1732310	1732310D00R	LL90003	3024237
1732315	-	LL90003	3003081
1732400	1732400D00R	LL90003	3024237
1732403	1732403D00R	LL90003	3024237
1732405	1732405D00R	LL90003	3024237
1732500	1732500D00R	LL90003	3024237
1732503	1732503D00R	LL90003	3024237
1732505	1732505D00R	LL90003	3024237
1732510	1732510D00R	LL90003	3024237
1734300	1734300D00R	LL90003	3024238
1734303	1734303D00R	LL90003	3024238
1734305	1734305D00R	LL90003	3024238
1734400	1734400D00R	LL90003	3024238
1734403	1734403D00R	LL90003	3024238
1734405	1734405D00R	LL90003	3024238
1734500	1734500D00R	LL90003	3024238
1734503	1734503D00R	LL90003	3024238
1734505	1734505D00R	LL90003	3024238
1702700	1702700D00R	LL9000	3003081
1702703	1702703D00R	LL9000	3003081
1702705	1702705D00R	LL9000	3003081
1702710	1702710D00R	LL9000	3003081
1702715	1702715D00R	LL9000	3003081
1702725	1702705D00R	LL9000	3003081
1703700	1703700D00R	LL9000	3003480
1703703	1703703D00R	LL9000	3003480

Part No.	Doors	Latches	Lanyards
1703705	1703705D00R	LL9000	3003480
1704705	1704705D00R	LL9000	3004713
1704710	1704710D00R	LL9000	3003081
1704715	1704715D00R	LL9000	3003081
1702595	1702595D00R	LL9000	3003081
1702600	1702600D00R	LL9000	3003081
1702603	1702603D00R	LL9000	3003081
1702605	1702605D00R	LL9000	3003081
1702610	1702610D00R	LL9000	3003081
1704600	3047158	LL9000	3004713
1704603	3047159	LL9000	3004713
1704610	3010773	LL9000	3004713
1704615	3047195	LL9000	3004713
1702650	1702650D00R	LL9000	-
1702653	1702653D00R	LL9000	-
1702655	1702655D00R	LL9000	-
1702660	1702660D00R	LL9000	-
1702500	1702500D00R	LL9000	3003081
1702503	1702503D00R	LL9000	3003081
1702505	1702505D00R	LL9000	3003081
1702510	1702510D00R	LL9000	3003081
1706400	1706400D00RB	LL90003	3033784
1706403	1706403D00RB	LL90003	3033784
1706405	1706405D00RB	LL90003	3033784
1706410	1706410D00RB	LL90003	3033784
1706415	1706415D00RB	LL90003	3033784
1706420	1706420D00RB	LL90003	3033784
1706425	1706425D00RB	LL90003	3033784
1706430	1706430D00RB	LL90003	3033784
1706960	-	LL90003	3033784
1706963	-	LL90003	3033784
1706965	-	LL90003	3033784
1706970	-	LL90003	3033784
1706975	-	LL90003	3033784
1706980	-	LL90003	3033784
1706985	-	LL90003	3033784
1706990	-	LL90003	3033784
1707960	-	LL90003	3033784
1707963	-	LL90003	3033784
1707965	-	LL90003	3033784
1707970	-	LL90003	3033784
1707975	-	LL90003	3033784
1707980	-	LL90003	3033784
1707985	-	LL90003	3033784
1707990	-	LL90003	3033784
1706500	1706500D00RB	LL90003	3033784
1706503	1706503D00RB	LL90003	3033784
1706505	1706505D00RB	LL90003	3033784
1706510	1706510D00RB	LL90003	3033784
1706515	1706515D00RB	LL90003	3033784
1706520	1706505D00RB	LL90003	3033784
1706525	1706510D00RB	LL90003	3033784
1706530	1706515D00RB	LL90003	3033784
1712200	-	LL9000	3003081
1712205	-	LL9000	3003081

Underbody Replacement Parts, continued

Part No.	Doors	Latches	Lanyards	Part No.	Doors	Latches	Lanyards	Part No.	Doors	Latches	Lanyards
1712210	-	LL9000	3003081	1705150	1705150D00RB	LL9000	3003480	1725133	1725133D00RB	LL9000	3004713
1705100	1705100D00RB	LL9000	3003081	1705153	1705153D00RB	LL9000	3003480	1725135	1725135D00R	LL9000	3004713
1705101	1705101D00RB	LL9000	3003081	1705160	1705160D00RB	LL9000	3003480	1725140	1725140D00R	LL9000	3004713
1705102	1705102D00RB	LL9000	3003081	1715100	1715100D00RB	LL9000	3003081	1725145	1725145D00RB	LL9000	3004713
1705103	1705103D00RB	LL9000	3003081	1715105	1715105D00RB	LL9000	3003081	1725147	1725147D00RB	LL9000	3004713
1705105	1705105D00RB	LL9000	3003081	1715110	1715110D00RB	LL9000	3003081	1725148	1725148D00RB	LL9000	3003480
1705110	1705110D00RB	LL9000	3003081	1715115	1715115D00RB	LL9000	3003081	1725149	1725149D00RB	LL9000	3003480
1705115	1705115D00RB	LL9000	3003081	1725100	1725100D00R	LL9000	3003081	1725150	1725150D00RB	LL9000	3003480
1705118	1705118D00RB	LL9000	3024237	1725101	1725101D00RB	LL9000	3003081	1725153	1725153D00RB	LL9000	3003081
1705119	-	LL9000	3003081	1725102	1725102D00RB	LL9000	3003081	1725160	1725160D00RB	LL9000	3003081
1705120	1705110D00RB	LL9000	3003081	1725103	1725103D00RB	LL9000	3003081	1735100	1735100D00R	LL90003	3003081
1705125	-	LL9000	3003081	1725105	1725105D00R	LL9000	3003081	1735103	1735103D00RB	LL90003	3003081
1705130	1705130D00RB	LL9000	3004713	1725110	1725110D00R	LL9000	3003081	1735105	1735105D00R	LL90003	3003081
1705133	1705133D00RB	LL9000	3004713	1725115	1725115D00RB	LL9000	3003081	1735130	1735130D00R	LL90003	3004713
1705135	1705135D00RB	LL9000	3004713	1725116	1725116D00RB	LL9000	3003081	1735133	1735133D00R	LL90003	3004713
1705140	1705140D00RB	LL9000	3004713	1725118	1725118D00RB	LL9000	3024237	1735135	1735135D00R	LL90003	3004713
1705145	1705145D00RB	LL9000	3004713	1725119	1725119D00RB	LL9000	3003081				
1705147	1705147D00RB	LL9000	3004713	1725120	1725120D00RB	LL9000	3003081				
1705148	1705148D00RB	LL9000	3003480	1725125	-	LL9000	3003081				
1705149	1705149D00RB	LL9000	3003480	1725130	1725130D00R	LL9000	3004713				

Barn Door Replacement Parts

PART NO.	DOORS WITH LATCH	DOOR WITHOUT LATCH	LATCHES
1702235	1702235D00RBWLCH	1702235D00RBNLCH	LL90003
1702240	1702240D00RBWLCH	1702240D00RBNLCH	LL90003
1702250	1702250D00RBWLCH	1702250D00RBNLCH	LL90003
1705200	1705200D00RBWLCH	1705200D00RBNLCH	LL90003
1705201	1705201D00RBWLCH	1705201D00RBNLCH	LL90003
1705203	1705203D00RBWLCH	1705203D00RBNLCH	LL90003
1705205	1705205D00RBWLCH	1705205D00RBNLCH	LL90003
1705210	1705210D00RBWLCH	1705210D00RBNLCH	LL90003
1705215	1705215D00RBWLCH	1705215D00RBNLCH	LL90003
1705303	1705303D00RBWLCH	1705303D00RBNLCH	LL90003
1705305	1705305D00RBWLCH	1705305D00RBNLCH	LL90003
1705310	1705310D00RBWLCH	1705310D00RBNLCH	LL90003
1705315	1705315D00RBWLCH	1705315D00RBNLCH	LL90003
1705333	1705333D00RBWLCH	1705333D00RBNLCH	LL90003
1705335	1705335D00RBWLCH	1705335D00RBNLCH	LL90003
1705340	1705340D00RBWLCH	1705340D00RBNLCH	LL90003
1705345	1705345D00RBWLCH	1705345D00RBNLCH	LL90003
1705350	1705350D00RBWLCH	1705350D00RBNLCH	LL90003
1705405	1705405D00RBWLCH	1705405D00RBNLCH	LL90003
1705410	1705410D00RBWLCH	1705410D00RBNLCH	LL90003
1705415	1705415D00RBWLCH	1705415D00RBNLCH	LL90003
1705420	1705420D00RBWLCH	1705420D00RBNLCH	LL90003
1705425	1705425D00RBWLCH	1705425D00RBNLCH	LL90003
1705430	1705430D00RBWLCH	1705430D00RBNLCH	LL90003
1705435	1705435D00RBWLCH	1705435D00RBNLCH	LL90003
1705440	1705440D00RBWLCH	1705440D00RBNLCH	LL90003
1705445	1705445D00RBWLCH	1705445D00RBNLCH	LL90003
1705450	1705450D00RBWLCH	1705450D00RBNLCH	LL90003

PART NO.	PAGE NO.	PART NO.	PAGE NO.	PART NO.	PAGE NO.	PART NO.	PAGE NO.	PART NO.	PAGE NO.
1701000	29	1702503	17	1703405	10	1705283	73	1706515	21
1701001	29	1702505	17	1703495	10	1705284	73	1706520	21
1701005	28	1702510	17	1703700	14	1705285	73	1706525	21
1701005B	28	1702595	15	1703703	14	1705286	73	1706530	21
1701006	28	1702600	15	1703705	14	1705303	26	1706803	26
1701006B	28	1702603	15	1703900	10, 53	1705305	26	1706805	26
1701010	28	1702605	15	1704300	9	1705310	26	1706810	26
1701010B	28	1702610	15	1704303	9	1705315	26	1706815	26
1701011	28	1702650	16	1704305	9	1705333	26	1706833	26
1701011B	28	1702653	16	1704310	9	1705335	26	1706835	26
1701012	28	1702655	16	1704315	9	1705340	26	1706840	26
1701015	28	1702660	16	1704400	10	1705345	26	1706845	26
1701016	28	1702700	14	1704403	10	1705350	26	1706850	26
1701030	29	1702703	14	1704405	10	1705405	19	1706905	19
1701031	29	1702705	14	1704410	10	1705410	19	1706910	19
1701040	29	1702710	14	1704415	10	1705415	19	1706915	19
1701041	29	1702715	14	1704600	15	1705420	19	1706920	19
1701280	70	1702725	14	1704603	15	1705425	19	1706925	19
1701281	70	1702840	33	1704610	15	1705430	19	1706930	19
1701285	70	1702840TRAY	33	1704615	15	1705435	19	1706935	19
1701380	70	1702850	33	1704705	14	1705440	19	1706940	19
1701385	70	1702850TRAY	33	1704710	14	1705445	19	1706945	19
1701551	34	1702860	33	1704715	14	1705450	19	1706950	19
1701556	34	1702860TRAY	33	1705100	23	1705640	38	1706960	20
1701565	34, 35	1702900	10	1705101	23	1705641	39	1706963	20
1701568	35	1702905	10	1705102	23	1705650	38	1706965	20
1701679	71	1702910	10	1705103	23	1705651	39	1706970	20
1701680	71	1702940	33	1705105	23	1705660	38	1706975	20
1701768	34	1702940TRAY	33	1705110	23	1705803	26	1706980	20
1702100	12	1702950	33	1705115	23	1705805	26	1706985	20
1702103	12	1702950TRAY	33	1705118	23	1705810	26	1706990	20
1702105	12	1702960	33	1705119	23	1705815	26	1707020	66
1702110	12	1702960TRAY	33	1705120	23	1705833	26	1707960	20
1702115	12	1703100	12	1705125	23	1705835	26	1707963	20
1702200	12	1703103	12	1705130	23	1705840	26	1707965	20
1702203	12	1703150	12	1705133	23	1705845	26	1707970	20
1702205	12	1703203	12	1705135	23	1705850	26	1707975	20
1702210	12	1703205	12	1705140	23	1705905	19	1707980	20
1702215	12	1703300	9, 53	1705145	23	1705910	19	1707985	20
1702235	27	1703303	9, 53	1705147	23	1705915	19	1707990	20
1702240	27	1703304	11, 53	1705148	23	1705920	19	1708310	9
1702250	27	1703305	9	1705149	23	1705925	19	1708410	10
1702295	9	1703310	9	1705150	23	1705930	19	1709410	59
1702300	9	1703312	9	1705153	23	1705935	19	1709415	59
1702303	9	1703320	9	1705160	23	1705940	19	1709420	59
1702305	9	1703322	9	1705180	74	1705945	19	1709425	59
1702310	9	1703324	9	1705181	74	1705950	19	1709430	59
1702315	9	1703326	9	1705182	74	1706400	20	1710305	61
1702317	9	1703328	9	1705183	74	1706403	20	1710308	61
1702325	9	1703330	9	1705190	75	1706405	20	1710315	61
1702400	10	1703349	9	1705200	27	1706410	20	1710318	61
1702403	10	1703350	9	1705201	27	1706415	20	1711010	63
1702405	10	1703351	11	1705203	27	1706420	20	1711020	63
1702406	13	1703352	11	1705205	27	1706425	20	1711025	63
1702410	10	1703353	9	1705210	27	1706430	20	1711030	63
1702411	13	1703355	11	1705215	27	1706500	21	1711205	61
1702415	10	1703400	10, 53	1705280	73	1706503	21	1711206	61
1702417	10	1703403	10, 53	1705281	73	1706505	21	1712010	65
1702500	17	1703404	11, 53	1705282	73	1706510	21	1712020	65

PART NO.	PAGE NO.	PART NO.	PAGE NO.	PART NO.	PAGE NO.	PART NO.	PAGE NO.	PART NO.	PAGE NO.
1712030	65	1725115	24	1739430	59	5239012	74	BP964824P	49
1712035	65	1725116	24	1742300	7	5239018	74	BP964824W	49
1712110	65	1725118	24	1742303	7	5239024	74	BP964824WLL	49
1712120	65	1725119	24	1742305	7	5411000	32	BP965724	47
1712200	21	1725120	24	1742310	7	5411005	32	BP965724B	47
1712205	21	1725125	24	1742315	7, 33	5411018	32	BP965724W	47
1712210	21	1725130	24	1742325	7, 33	562109166	55	CDC01Z	77
1712230	66	1725133	24	1742335	7, 33	562133202	55	DM0212BF	78
1712240	66	1725135	24	1742336	7, 33	5621827	55	DM0212BM	78
1712250	66	1725140	24	1744300	7	5621928	55	DM1212B	78
1712255	66	1725145	24	1744303	7	5622436	55	FNE031018034	78
1712260	66	1725147	24	1744305	7	5622537	55	L3890RLS	77
1715100	24	1725148	24	1751651	36	5623654	55	L38RLSCH545	77
1715105	24	1725149	24	1751656	36	5623755	55	L8815	76
1715110	24	1725150	24	1751661	36	5624872	55	L8815GO	76
1715115	24	1725153	24	1751663	36	5624973	55	L8816	76
1717100	27	1725160	24	1751664	36	5626090	55	L8816R	76
1717105	27	1725640	38	1751665	36	5626191	55	L8825	76
1717110	27	1725641	39	1751668	36	56296144	55	L882502	76
1718050	69	1725650	38	1752151	36	56297145	55	L8835	76
1718055	69	1725651	39	1752156	36	5910024	75	L8855	76
1718060	69	1725660	38	1752161	36	8000SSL	77	L8915	76
1718065	69	1729410	59	1752163	36	8000SSN	77	LL9000	76
1718070	69	1729415	59	1752164	36	88CH510	77	LL90003	76
1718350	69	1729420	59	1752165	36	88CH545	77	UB623516	54
1718355	69	1729425	59	1752168	36	9031100	67		
1718360	69	1729430	59	1753151	37	9031105	67		
1718365	69	1731020	63	1753156	37	9031110	67		
1718370	69	1732300	13	1753161	37	99170	79		
1718450	69	1732303	13	1753163	37	BP141624	53		
1718455	69	1732305	13	1753164	37	BP824624	45		
1718460	69	1732310	13	1753165	37	BP824624B	45		
1718465	69	1732315	13	1753168	37	BP824624P	45		
1718470	69	1732400	13	19CH545	77	BP824624W	45		
1720305	61	1732403	13	3005833	77	BP825524	43		
1720308	61	1732405	13	3008086	54	BP826224	43		
1720315	61	1732500	13	3008745	78	BP826254	51		
1720318	61	1732503	13	3009122	55	BP826524	43		
1721010	63	1732505	13	3009938	55	BP826524B	43		
1721020	63	1732510	13	3010339	78	BP826524P	43		
1721025	63	1734300	13	3019101	77	BP826524W	43		
1721030	63	1734303	13	3022729	78	BP827024	43		
1721551	35	1734305	13	3023460	78	BP827054	51		
1721556	35	1734400	13	3026586	78	BP855524B	43		
1721561	35	1734403	13	3028392	78	BP855524P	43		
1721565	35	1734405	13	3028786	78	BP855524W	43		
1721568	35	1734500	13	3029916	78	BP855548B	51		
1721768	34	1734503	13	3029917	78	BP855548W	51		
1722010	65	1734505	13	3030481	77	BP855924	45		
1722305	61	1735100	25	3035896	55	BP855924B	45		
1722551	35	1735103	25	3036255	69	BP855924P	45		
1722568	35	1735105	25	3036256	69	BP855924W	45		
1722768	34	1735130	25	3036257	69	BP925824	43		
1725100	24	1735133	25	3037014	54	BP925824B	43		
1725101	24	1735135	25	3043331	78	BP925824P	43		
1725102	24	1739410	59	3045508	78	BP925824W	43		
1725103	24	1739415	59	3047012	79	BP964824	49		
1725105	24	1739420	59	3047140	78	BP964824B	49		
1725110	24	1739425	59	39LL71	77	BP964824BLL	49		

The Buyers family of manufacturing companies

Tracom

B **Boomerang**
RUBBER, INC.

Romotech
Rotational Molding Technologies, Inc.

P **PROGRESSIVE**
POWDER COATING, INC.



www.buyersproducts.com

Buyers
PRODUCTS COMPANY 

SnowDogg 
by Buyers

SaltDogg 
by Buyers

ScoopDogg 
by Buyers

DumperDogg 
by Buyers

TBLIT_K