

WESTIN®

ENGINEERED FOR ENTHUSIASTS

S

SUPERWINCH



APPLICATION GUIDE

2023

WESTIN[®]
ENGINEERED FOR ENTHUSIASTS

S
SUPERWINCH



***WESTIN AUTOMOTIVE PROVIDES GREAT LOOKING, FUNCTIONAL PRODUCTS
FOR TRUCKS, JEEPS & SUV'S. DELIVERING OUTSTANDING CUSTOMER
SERVICE AND LONG-LASTING QUALITY YOU CAN COUNT ON.***

- ENGINEERED FOR ENTHUSIASTS SINCE 1970 -

NERF STEP BARS

NEW - XTS Rock Sliders	5
NEW - Outlaw Drop Nerf Step Bars	6
HDX Stainless Drop Nerf Step Bars	7
HDX Drop Nerf Step Bars	7
HDX Stainless Drop W2W Nerf Step Bars	9
HDX Drop W2W Nerf Step Bars	9
HDX Xtreme Nerf Step Bars	11
R5 M-Series W2W Nerf Step Bars	13
R5 M-Series XD W2W Nerf Step Bars	15
R5 XD Nerf Step Bars	16
R5 Nerf Step Bars	17
PRO TRAXX 4 Oval Nerf Step Bars	19
PRO TRAXX 5 Oval Nerf Step Bars	21
PRO TRAXX 5 Oval W2W Nerf Step Bars	23
PRO TRAXX 6 Oval Nerf Step Bars	25
R7 Nerf Step Bars	26
Outlaw Nerf Step Bars	28
Platinum 4 Oval Nerf Step Bars	29
Platinum 4 Oval W2W Nerf Step Bars	31
Premier 4 Oval Nerf Step Bars	32
Premier 6 Oval Nerf Step Bars	35
E-Series 3 Nerf Step Bars	38
Signature 3 Nerf Step Bars	41

RUNNING BOARDS

NEW - Pro-e Running Boards	44
SG6 LED Running Boards	45
SG6 Running Boards	47
Grate Steps Running Boards	50
Thrasher Running Boards	53
Sure-Grip Running Boards	54
Molded Running Boards	57
Nerf Step Bars/Running Boards Replacement Service Kits	59

GRILLE GUARDS & WINCH MOUNTS

NEW - XTS Brush Guard	61
NEW - HDX Modular Grille Guard	62
Sportsman X Grille Guard	63
HDX Grille Guard	64
HDX Winch Mount Grille Guard	66
Sportsman Grille Guard	67
HDX B-Force Flush Mount LED Kit	69
MAX Winch Mounting System	70
Grille Guard Accessories	71

BUMPERS

NEW - XTS Front Bumper	73
NEW - Pro-Series Front Bumper	74
NEW - Pro-Series Rear Bumper	76
Pro-Mod Front Bumper	77
HDX Bandit Front Bumper	78
HDX Bandit Rear Bumper	79
Outlaw Front and Rear Bumper	80
FEY Perfect Match Series Bumpers	81
FEY Universal Series Bumpers	82

FORD BRONCO

NEW - Mesa Roof Rack	84
NEW - XTS Front Bumper	84
NEW - XTS Brush Guard	85
NEW - XTS Overhead Light Mount	86
NEW - XTS Pinch Weld Cover	86
Pro-Mod Front Bumper	87
Pro-Series Rear Bumper	87
Step Bars & Running Boards	88

JEEP® WRANGLER/GLADIATOR

NEW - Pro-e Running Boards	90
NEW - XTS Rock Sliders	90
WJ2 Stubby Bumpers	91
WJ2 Full Width Bumpers	92
WJ2 Rear Bumpers	93
Jeep Accessories	94
LED Rock Light Kit	95
Front and Rear Inner Fenders	95
Front and Rear Tube Fenders	96
Triple Tube Rock Rail Steps & Rock Slider Steps	97
LED Light Mounts	98
Skid Plates	99
Nerf Step Bars and Running Boards	100
MAX Winch Mounting System	101
LED Hood Scoops	102
Body Trim	102

BULL BARS

Ultimate LED Bull Bar	104
Ultimate Bull Bar	105
E-Series Bull Bar	106
Safari Bull Bar	107

WINCHES & ACCESSORIES

NEW - Superwinch Tiger Shark 18000	109
NEW - Superwinch Tiger Shark 15000	110
NEW - Superwinch AC 1500 Winch	111
NEW - Superwinch Terra Series	112
Superwinch SX Series	114
Superwinch Talon & Tiger Shark	116-117
Superwinch UT 3000 & LP Series	118
Superwinch S Series & LT Series	119-120
NEW - Auxiliary Battery Mount	121
Superwinch Winch2Go	121
Superwinch Winch Accessories	122
Superwinch Replacement Parts	124

TRUCK BED ACCESSORIES

NEW - Mesa Roof Rack & Side Ladder	127
Overland Cargo Rack	128
HLR Truck Rack	129
HD Headache Rack	130
HD Ladder Rack	131
HDX DEF Tank Skid Plate	131
Truck-Pal Tailgate Ladder	131
Truck Bed and Tailgate Mats	132
Platinum Oval Bed Rails	133
Front and Tailgate Caps	133
Bed Caps	134
Hitch Steps	135

TOOL BOXES

Pro-Series Tool Boxes	136
-----------------------	-----

LED LIGHTING

Performance2X Double Row Light Bar	141
EF2 Double Row Light Bar	141
B-Force Double Row Light Bar	142
B-Force Single Row Light Bar	142
Xtreme Single Row Light Bar	143
Fusion5 Light	143
HyperQ B-Force Auxiliary Lights	144
HyperQ Auxiliary Lights	144
FMAQ Flush Mount Auxiliary Lights	144
FM6 Flush Mount Auxiliary Lights	144
Ultra Auxiliary Light	145
Axis Auxiliary Lights	145
Quadrant Auxiliary Light	145
Work LED Utility Lights and LED Accessories	146

FLOOR & CARGO LINERS

Sure Fit Floor Liners	147
-----------------------	-----

BODY TRIM PRODUCTS

Platinum Bug Shields	152
Ultraguard Bug Shields	153
Tape On Wind Deflectors	154
In Channel Wind Deflectors	156
Wind Guard Wind Deflectors	157
Hood Scoops	158
Cab Guard Wind Deflectors	158

RETAIL SUPPORT & WARRANTY

Retail Support	159
Westin Warranty Policy	161
Superwinch Warranty Policy	163



NEW! - XTS Rock Sliders 5



NEW! - Outlaw Drop Nerf Step Bars 6



HDX (Stainless and Non) Drop Nerf Step Bars 7



HDX Xtreme Nerf Step Bars 11



R5 M-Series W2W Nerf Step Bars 13



Pro Traxx 4 Oval Nerf Step Bars 19



R7 Nerf Step Bars 26



Outlaw Nerf Step Bars 28



Platinum 4 Oval Nerf Step Bars 29



Premier 6 Oval Nerf Step Bars 35



E-Series 3 Nerf Step Bars 38



Signature 3 Nerf Step Bars 41

NEW! XTS ROCK SLIDERS
TEXTURED BLACK

- » Custom profile to match vehicle's contour
- » Reinforced for maximum strength
- » Protects vehicle rocker panels from potential damage
- » 12-gauge steel channel
- » 1-3/4" diameter, .120" thick wall round tube
- » Bolt-on step plate with polyurea texture coated grip surface
- » Hardware and mounting brackets included
- » Electrostatic base coat provides long lasting corrosion protection
- » Bolt-on installation - no drilling required
- » Available in textured black powder coat finish

FINISH: Textured Black Powder Coat

MATERIAL: E-Coated Steel

WARRANTY: 3-Year

12-GAUGE STEEL

TEXTURED BLACK
 POWDER COAT FINISH

POLYUREA TEXTURE
 COATED GRIP SURFACE
 STEP PLATE

1-3/4" DIAMETER
 W/ .120" THICK WALL
 ROUND TUBE



START	END	MAKE	MODEL	TEXTURED BLACK
2021	2023	Ford	Bronco 2Dr (Excl. Bronco Sport)	42-14185
2021	2023	Ford	Bronco 4Dr (Excl. Bronco Sport)	42-14199
2020	2023	Jeep	Gladiator	42-14169
2018	2023	Jeep	Wrangler JL Unlimited 4Dr	42-14068

WESTIN

NERF STEP BARS

NEW! OUTLAW DROP NERF STEP BARS

TEXTURED BLACK

- Stylized step with premium features at an affordable price
- Constructed of 1.5" diameter mandrel bent steel tube
- Protects vehicle rocker panels from potential damage
- Fully welded cab length top plate
- Distinctive 4" drop die-stamped step plate provides maximum traction while cleaning dirt, mud, and debris
- Bolt-on installation - no drilling required
- Hardware and mounting brackets included
- E-Coated base coat provides long lasting corrosion protection
- Available in textured black powder coat finish
- Patent US D984946 Westin Automotive Products, Inc.

FINISH: Textured Black Powder Coat

MATERIAL: E-Coated Steel

WARRANTY: 3-Year

STYLIZED STEP WITH PREMIUM FEATURES AT AN AFFORDABLE PRICE

CORROSION RESISTANT BLACK POWDER COATED

START	END	MAKE	MODEL	TEXTURED BLACK
2015	2023	Chevrolet	Colorado Crew Cab	20-14019
2004	2019	Chevrolet	Silverado 1500 Crew Cab	20-11966
2014	2018	Chevrolet	Silverado 1500 Crew Cab	20-13725
2019	2023	Chevrolet	Silverado 1500 Crew Cab (Excl. 2019 LD)	20-14138
1999	2019	Chevrolet	Silverado 1500 Double Ext Cab	20-11688
2014	2018	Chevrolet	Silverado 1500 Double Cab	20-13718
2019	2023	Chevrolet	Silverado 1500 Double Cab (Excl. 2019 LD)	20-14125
2001	2019	Chevrolet	Silverado 2500/3500	20-11965
2015	2019	Chevrolet	Silverado 2500/3500 Crew Cab (Excl. Diesel)	20-13725
2020	2023	Chevrolet	Silverado 2500/3500 Crew Cab	20-14135
2001	2019	Chevrolet	Silverado 2500/3500 Double Cab Ext Cab	20-11688
2015	2019	Chevrolet	Silverado 2500/3500 Double Cab (Excl. Diesel)	20-13718
2020	2023	Chevrolet	Silverado 2500/3500 Double Cab	20-14125
2019	2019	Chevrolet	Silverado LD Double Cab	20-13718
2009	2018	Dodge	Ram 1500 Crew Cab 4	20-13555
2009	2018	Dodge	Ram 1500 Quad Cab	20-13555
2010	2023	Dodge	Ram 2500/3500 Crew Cab 4	20-13555
2021	2023	Ford	Bronco 2Dr (Excl. Bronco Sport)	20-14185
2021	2023	Ford	Bronco 4Dr (Excl. Bronco Sport)	20-14195
2015	2023	Ford	F-150 SuperCab	20-13935
2015	2023	Ford	F-150 SuperCrew	20-13945
1999	2016	Ford	F-250/350 Crew Cab	20-11335
2017	2023	Ford	F-250/350 Crew Cab	20-13945
2017	2023	Ford	F-250/350 SuperCab	20-13935
2015	2023	GMC	Canyon Crew Cab	20-14015
2004	2019	GMC	Sierra 1500 Crew Cab	20-11955
2014	2018	GMC	Sierra 1500 Crew Cab	20-13724
2019	2023	GMC	Sierra 1500 Crew Cab (Excl. 2019 Limited)	20-14138
1999	2019	GMC	Sierra 1500 Double Ext Cab	20-11688
2014	2018	GMC	Sierra 1500 Double Cab	20-13719
2019	2023	GMC	Sierra 1500 Double Cab (Excl. 2019 Limited)	20-14125
2001	2019	GMC	Sierra 2500/3500	20-11955
2015	2019	GMC	Sierra 2500/3500 Crew Cab (Excl. Diesel)	20-13724
2020	2023	GMC	Sierra 2500/3500 Crew Cab	20-14135
2001	2019	GMC	Sierra 2500/3500 Double Cab Ext Cab	20-11688
2015	2019	GMC	Sierra 2500/3500 Double Cab (Excl. Diesel)	20-13719
2020	2023	GMC	Sierra 2500/3500 Double Cab	20-14125
2019	2019	GMC	Sierra LD Double Cab	20-13719
2020	2023	Jeep	Gladiator	20-14165
2007	2018	Jeep	Wrangler JK Unlimited 4Dr	20-13295
2018	2023	Jeep	Wrangler JL Unlimited 4Dr	20-14055
2019	2023	Ram	1500 Classic Crew Cab	20-13555
2019	2023	Ram	1500 Classic Quad Cab	20-13555
2009	2018	Ram	1500 Crew Cab 4	20-13555
2009	2018	Ram	1500 Quad Cab	20-13555
2019	2023	Ram	1500 Crew Cab (Excl. Classic)	20-14085
2019	2023	Ram	1500 Quad Cab (Excl. Classic)	20-14095
2010	2023	Ram	2500/3500 Crew Cab 4	20-13555
2010	2017	Toyota	4Runner Trail (Excl. Limited)	20-13035
2014	2023	Toyota	4Runner 4th Anniv/SRS & Premium/TRD Off-Road & Pro/Trail Venture (Excl. Limited/Highshade/TRD Sport)	20-13635
2005	2023	Toyota	Tacoma Double Cab	20-12775
2007	2021	Toyota	Tundra CrewMax	20-13255
2022	2023	Toyota	Tundra CrewMax	20-14235
2007	2021	Toyota	Tundra Double Cab	20-13245
2022	2023	Toyota	Tundra Double Cab	20-14225

FOOTNOTES: 4. Excludes Chassis Cab With Diesel Exhaust Fluid (DEF) Tank Vehicles.

HDX DROP NERF STEP BARS

- ▶ Manufactured from corrosion resistant, black powder coated stainless steel
- ▶ Die stamped stainless steel step areas for maximum traction
- ▶ Protects vehicle rocker panels from potential damage
- ▶ Provides over 2 more inches of foot/heel step area than our competitors
- ▶ Notched bar design with heavy-duty step plate
- ▶ Fits tight to rocker panel for a solid fit and rugged look
- ▶ Solid 1-piece construction
- ▶ Bolt-on installation – no drilling required for most applications
- ▶ Mount kit included

FINISH: Textured Black Powder Coat
 MATERIAL: 410 Stainless Steel
 WARRANTY: 5-Year

FINISH: Textured Black Powder Coat
 MATERIAL: E-Coated Steel
 WARRANTY: 3-Year



**SEMA BEST EXTERIOR
 ACCESSORY PRODUCT!**

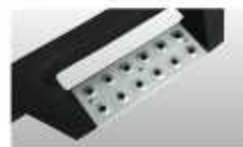

**STAINLESS STEEL STEP
 REPLACEMENT P/N#
 66-100011 (11") 66-100015 (15")**

START	END	MAKE	MODEL	MOUNTING	TEXTURED BLACK E-COATED STEEL	TEXTURED BLACK STAINLESS STEEL
2015	2023	Chevrolet	Colorado Crew Cab	Rocker Pnl	66-14015	66-14015Z
2016	2022	Chevrolet	Colorado Ext Cab	Rocker Pnl	66-14006	66-14006Z
2004	2013	Chevrolet	Silverado 1500 Crew Cab	Body Mnt	66-11955	66-11955Z
2007	2013	Chevrolet	Silverado 1500 Crew Cab (Excl. 2007 Classic)	Rocker Pnl	66-13725	66-13725Z
2019	2023	Chevrolet	Silverado 1500 Crew Cab (Excl. 2019 LD)	Rocker Pnl	66-14126	66-14126Z
2019	2023	Chevrolet	Silverado 1500 Double (Excl. 2019 LD)	Rocker Pnl	66-14128	66-14128Z
2007	2013	Chevrolet	Silverado 1500 Double/Ext Cab (Excl. 2007 Classic)	Rocker Pnl	66-13715	66-13715Z
1999	2013	Chevrolet	Silverado 1500 Ext Cab	Body Mnt	66-11685	66-11685Z
2019	2023	Chevrolet	Silverado 1500 Reg Cab	Rocker Pnl	66-14115	—
2001	2019	Chevrolet	Silverado 2500/3500	Body Mnt	66-11968	66-11968Z
2007	2019	Chevrolet	Silverado 2500/3500HD Crew Cab (Excl. 2007 Classic)	Rocker Pnl	66-13725	66-13725Z
2020	2023	Chevrolet	Silverado 2500/3500 Crew Cab	Rocker Pnl	66-14128	66-14128Z
2007	2019	Chevrolet	Silverado 2500/3500HD Double/Ext Cab (Excl. 2007 Classic)	Rocker Pnl	66-13715	66-13715Z
2019	2023	Chevrolet	Silverado 2500/3500 Double Cab (Excl. 2019 LD)	Rocker Pnl	66-14128	66-14128Z
2001	2019	Chevrolet	Silverado 2500/3500 Double/Ext Cab	Body Mnt	66-11685	66-11685Z
2020	2023	Chevrolet	Silverado 2500/3500 Reg Cab	Rocker Pnl	66-14115	—
2019	2019	Chevrolet	Silverado LD Double Cab	Rocker Pnl	66-13715	66-13715Z
2009	2018	Dodge	Ram 1500 Crew Cab	Rocker Pnl	66-13565	66-13565Z
2009	2018	Dodge	Ram 1500 Quad Cab	Rocker Pnl	66-13555	66-13555Z
2010	2023	Dodge	Ram 2500/3500 Crew Cab 3	Rocker Pnl	66-13565	66-13565Z
2021	2023	Ford	Bronco 201 (Excl. Bronco Sport)	Rocker Pnl	66-14185	—
2021	2023	Ford	Bronco 401 (Excl. Bronco Sport)	Rocker Pnl	66-14195	66-14195Z
2015	2023	Ford	F-150 SuperCab	Rocker Pnl	66-13935	66-13935Z
2009	2014	Ford	F-150 SuperCrew	Rocker Pnl	66-13525	66-13525Z

CONTINUED ON NEXT PAGE →

WESTIN[®] NERF STEP BARS

HDX DROP NERF STEP BARS CONTINUED



START	END	MAKE	MODEL	MOUNTING	TEXTURED BLACK E-COATED STEEL	TEXTURED BLACK STAINLESS STEEL
2016	2023	Ford	F-150 SuperCrew	Rocker Pnl	66-13946	66-139452
2017	2023	Ford	F-250/350 Crew Cab	Rocker Pnl	66-13946	66-139452
2017	2023	Ford	F-250/350 SuperCab	Rocker Pnl	66-13939	66-139382
1999	2016	Ford	F-250/350/450/550 Super Duty Crew Cab	Rocker Pnl	66-11039	66-110382
1999	2016	Ford	F-250/350/450/550 Super Duty SuperCab	Rocker Pnl	66-111315	66-111312
2019	2023	Ford	Ranger SuperCab	Rocker Pnl	66-14145	66-141452
2019	2023	Ford	Ranger SuperCrew	Rocker Pnl	66-14155	66-14152
2016	2023	GMC	Canyon Crew Cab	Rocker Pnl	66-14015	66-140152
2016	2023	GMC	Canyon Ext Cab	Rocker Pnl	66-14005	66-140052
2004	2019	GMC	Sierra 1500 Crew Cab	Body Mnt	66-11995	66-119952
2007	2016	GMC	Sierra 1500 Crew Cab (Excl. 2007 Classic)	Rocker Pnl	66-13725	66-137252
2019	2023	GMC	Sierra 1500 Crew Cab (Excl. 2019 Limited)	Rocker Pnl	66-14105	66-141052
2019	2023	GMC	Sierra 1500 Double (Excl. 2019 Limited)	Rocker Pnl	66-14125	66-141252
2007	2016	GMC	Sierra 1500 Double/Ext Cab (Excl. 2007 Classic)	Rocker Pnl	66-13715	66-137152
1999	2013	GMC	Sierra 1500 Ext Cab	Body Mnt	66-11685	66-116852
2019	2019	GMC	Sierra 1500 Limited Double Cab	Rocker Pnl	66-13719	66-137192
2019	2023	GMC	Sierra 1500 Reg Cab	Rocker Pnl	66-14115	—
2001	2019	GMC	Sierra 2500/3500	Body Mnt	66-11995	66-119952
2007	2019	GMC	Sierra 2500/3500 Crew Cab (Excl. 2007 Classic)	Rocker Pnl	66-13725	66-137252
2020	2023	GMC	Sierra 2500/3500 Crew Cab	Rocker Pnl	66-14105	66-141052
2019	2023	GMC	Sierra 2500/3500 Double Cab	Rocker Pnl	66-14125	66-141252
2001	2019	GMC	Sierra 2500/3500 Double/Ext Cab	Body Mnt	66-11685	66-116852
2007	2019	GMC	Sierra 2500/3500 Double/Ext Cab (Excl. 2007 Classic)	Rocker Pnl	66-13715	66-137152
2020	2023	GMC	Sierra 2500/3500 Reg Cab	Rocker Pnl	66-14115	—
2007	2019	GMC	Sierra 2500/3500HD Crew Cab (Excl. 2007 Classic)	Rocker Pnl	66-13725	66-137252
2020	2023	Jeep	Gladiator	Rocker Pnl	66-14165	66-141652
2007	2016	Jeep	Wrangler JK 2Dr	Rocker Pnl	66-13315	66-133152
2007	2016	Jeep	Wrangler JK Unlimited 4Dr	Rocker Pnl	66-13295	66-132952
2016	2023	Jeep	Wrangler JL 2Dr	Rocker Pnl	66-14055	66-140552
2016	2023	Jeep	Wrangler JL Unlimited 4Dr	Rocker Pnl	66-14065	66-140652
2022	2023	Nissan	Frontier Crew Cab	Rocker Pnl	66-14215	66-142152
2017	2023	Nissan	Titan Crew Cab	Rocker Pnl	66-14025	66-140252
2016	2023	Nissan	Titan XD Crew Cab	Rocker Pnl	66-14025	66-140252
2019	2023	Ram	1500 Classic Crew Cab	Rocker Pnl	66-13565	66-135652
2019	2023	Ram	1500 Classic Quad Cab	Rocker Pnl	66-13555	66-135552
2009	2016	Ram	1500 Crew Cab	Rocker Pnl	66-13865	66-138652
2019	2023	Ram	1500 Crew Cab (Excl. Classic)	Rocker Pnl	66-14095	66-140952
2009	2016	Ram	1500 Quad Cab	Rocker Pnl	66-13565	66-135652
2019	2023	Ram	1500 Quad Cab (Excl. Classic)	Rocker Pnl	66-14095	66-140952
2010	2023	Ram	2500/3500 Crew Cab ¹³	Rocker Pnl	66-13865	66-138652
2014	2023	Toyota	4Runner 4Dr Anvrl SR5 & Premium TRD Off-Road & Pro-Trail/Venture (Excl. Limited/Nightshade TRD Sport)	Rocker Pnl	66-13835	66-138352
2010	2017	Toyota	4Runner Trail (Excl. Limited)	Rocker Pnl	66-13835	66-138352
2005	2023	Toyota	Tacoma Access Cab	Rocker Pnl	66-12675	—
2006	2023	Toyota	Tacoma Double Cab	Rocker Pnl	66-12775	66-127752
2007	2021	Toyota	Tundra CrewMax	Rocker Pnl	66-13255	66-132552
2022	2023	Toyota	Tundra CrewMax	Rocker Pnl	66-14235	66-142352
2007	2021	Toyota	Tundra Double Cab	Rocker Pnl	66-13245	66-132452
2022	2023	Toyota	Tundra Double Cab	Rocker Pnl	66-14225	66-142252

FOOTNOTES: 13. Excludes Chassis Cab With Diesel Exhaust Fluid (DEF) Tank Vehicles



NERF STEP BARS

WESTIN

HDX DROP WHEEL-TO-WHEEL NERF STEP BARS

- ▶ Manufactured from corrosion resistant black powder coated stainless steel
- ▶ Stylish Wheel-To-Wheel (W2W) length step bars
- ▶ Protects vehicle rocker panels from potential damage
- ▶ Die stamped stainless steel step areas for maximum traction
- ▶ Includes a third step for easy truck bed access
- ▶ Provides over 2 more inches of toeheel step area than our competitors
- ▶ Notched bar design with heavy-duty step plate
- ▶ Rust resistant step plates
- ▶ Removable step plates for easy cleaning
- ▶ Fits tight to rocker panel for a solid fit and rugged look
- ▶ Solid 1-piece construction
- ▶ Bolt-on installation – no drilling required for most applications
- ▶ Includes Westin exclusive Isolator bracket and mount kit

FINISH: Textured Black Powder Coat
MATERIAL: 410 Stainless Steel
WARRANTY: 5-Year

FINISH: Textured Black Powder Coat
MATERIAL: E-Coated Steel
WARRANTY: 3-Year

SOLID 1-PIECE CONSTRUCTION

CORROSION RESISTANT
BLACK POWDER COATED
E-COATED STEEL

DIE STAMPED
STAINLESS STEEL STEP
AREAS FOR MAXIMUM
TRACTION

WESTIN EXCLUSIVE
ISOLATOR BRACKET



START	END	MAKE	MODEL
2007	2013	Chevrolet	Silverado 1500 Crew Cab (5.5' Bed)(Excl. 2007 Classic) ¹
2019	2020	Chevrolet	Silverado 1500 Crew Cab (5.5' Bed)(Excl. 2019 LD)
2007	2013	Chevrolet	Silverado 1500 Crew Cab (6.5' Bed)(Excl. 2007 Classic) ¹
2019	2020	Chevrolet	Silverado 1500 Crew Cab (6.5' Bed)(Excl. 2019 LD)
2014	2013	Chevrolet	Silverado 1500 Double Cab (6.5' Bed) ¹
2019	2020	Chevrolet	Silverado 1500 Double Cab (6.5' Bed)(Excl. 2019 LD)
2007	2019	Chevrolet	Silverado 2500/3500 Crew Cab (6.5' Bed) & Dually (8' Bed) ¹
2020	2020	Chevrolet	Silverado 2500/3500 Crew Cab (6.5' Bed)
2007	2019	Chevrolet	Silverado 2500/3500 Crew Cab (8' Bed)(Excl. 2007 Classic)(Excl. Dually) ¹
2020	2020	Chevrolet	Silverado 2500/3500 Crew Cab (8' Bed)
2015	2019	Chevrolet	Silverado 2500/3500 Double Cab (6.5' Bed) & Dually (8' Bed) ¹
2020	2020	Chevrolet	Silverado 2500/3500 Double Cab (6.5' Bed)
2019	2019	Chevrolet	Silverado LD Double Cab (6.5' Bed) ¹
2009	2010	Dodge	Ram 1500 Crew Cab (6.5' Bed) ^{1,2}
2009	2018	Dodge	Ram 1500 Crew Cab (6.5' Bed) ^{1,4}
2010	2018	Dodge	Ram 2500/3500 Crew Cab (6.5' Bed) ^{1,4}

TEXTURED BLACK
E-COATED STEEL

TEXTURED BLACK
STAINLESS STEEL

CONTINUED ON NEXT PAGE

WESTIN

NERF STEP BARS

HDX DROP WHEEL-TO-WHEEL NERF STEP BARS CONTINUED



START	END	MAKE	MODEL	TEXTURED BLACK E-COATED STEEL	TEXTURED BLACK STAINLESS STEEL
2010	2018	Dodge	Ram 2500/3500 Crew Cab (8' Bed)(Excl. Dually) ^{1,2}	66-534338	66-524352
2017	2022	Ford	F-250/350 Crew Cab (6.75' Bed)	66-534028	66-534029
1999	2016	Ford	F-250/350/450/550 Crew Cab (6.75' Bed)	66-534018	66-534019
2007	2018	GMC	Sierra 1500 Crew Cab (5.8' Bed)(Excl. 2007 Classic) ^{1,2}	66-534665	66-534662
2019	2023	GMC	Sierra 1500 Crew Cab (5.8' Bed)(Excl. 2019 Limited)	66-534635	66-534632
2007	2018	GMC	Sierra 1500 Crew Cab (6.6' Bed)(Excl. 2007 Classic) ^{1,2}	66-534678	66-534679
2019	2023	GMC	Sierra 1500 Crew Cab (6.6' Bed)(Excl. 2019 Limited)	66-534698	66-534699
2014	2018	GMC	Sierra 1500 Double Cab (6.8' Bed) ^{1,2}	66-534695	66-534692
2019	2023	GMC	Sierra 1500 Double Cab (6.8' Bed)(Excl. 2019 Limited)	66-534715	66-534712
2019	2019	GMC	Sierra 1500 Limited Double Cab (6.8' Bed) ^{1,2}	66-534598	66-534599
2007	2019	GMC	Sierra 2500/3500 Crew Cab (6.6' Bed) & Dually (8' Bed) ^{1,2}	66-534578	66-534579
2020	2023	GMC	Sierra 2500/3500 Crew Cab (6.6' Bed)	66-534765	66-534762
2007	2019	GMC	Sierra 2500/3500 Crew Cab (8' Bed)(Excl. 2007 Classic)(Excl. Dually) ^{1,2}	66-534835	66-534832
2020	2023	GMC	Sierra 2500/3500 Crew Cab (8' Bed)	66-534778	66-534779
2015	2019	GMC	Sierra 2500/3500 Double Cab (6.6' Bed) & Dually (8' Bed) ^{1,2}	66-534596	66-534597
2020	2023	GMC	Sierra 2500/3500 Double Cab (8' Bed)	66-534755	66-534752
2019	2023	Ram	1500 Classic Crew Cab (5.8' Bed) ^{1,2}	66-534318	66-534319
2019	2023	Ram	1500 Classic Crew Cab (6.6' Bed) ^{1,2}	66-534328	66-534329
2009	2018	Ram	1500 Crew Cab (5.8' Bed) ^{1,2}	66-534316	66-534317
2019	2023	Ram	1500 Crew Cab (5.8' Bed)(Excl. Classic) ⁴	66-534705	66-534702
2009	2018	Ram	1500 Crew Cab (6.6' Bed) ^{1,2}	66-534325	66-534326
2019	2023	Ram	1500 Crew Cab (6.6' Bed)(Excl. Classic) ⁴	66-534728	66-534729
2019	2023	Ram	1500 Quad Cab (5.8' Bed)(Excl. Classic) ⁴	66-534738	66-534735
2010	2018	Ram	2500/3500 Crew Cab (5.8' Bed) ^{1,2}	66-534325	66-534326
2019	2023	Ram	2500/3500 Crew Cab (5.8' Bed) ^{1,2}	66-534735	66-534732
2010	2018	Ram	2500/3500 Crew Cab (8' Bed)(Excl. Dually) ^{1,2}	66-534338	66-534339
2019	2023	Ram	2500/3500 Crew Cab (8' Bed)(Excl. Dually) ^{1,2}	66-534345	66-534342
2016	2023	Toyota	Tacoma Double Cab (6' Bed) ¹	66-534188	66-534189

FOOTNOTES: 1. Requires Drilling. 2. May Require Minor Trimming Of Aftermarket Fender Flares If Equipped. 3. May Require Minor Trimming Of Rear OEM Fender Flares. 4. Requires Removal Of Plastic Rock Guard On Rear Wheel Well. 6. Requires Removal Of Bed Trim.



HDX XTREME NERF STEP BARS

TEXTURED BLACK

- Oversized step areas for easier cab entry and exit
- Injection molded polymer step pad
- Protects vehicle rocker panels from potential damage
- Fully welded construction
- Textured black powder coat finish
- Mount kit included

FINISH: Textured Black Powder Coat

MATERIAL: E-Coated Steel

WARRANTY: 3-Year

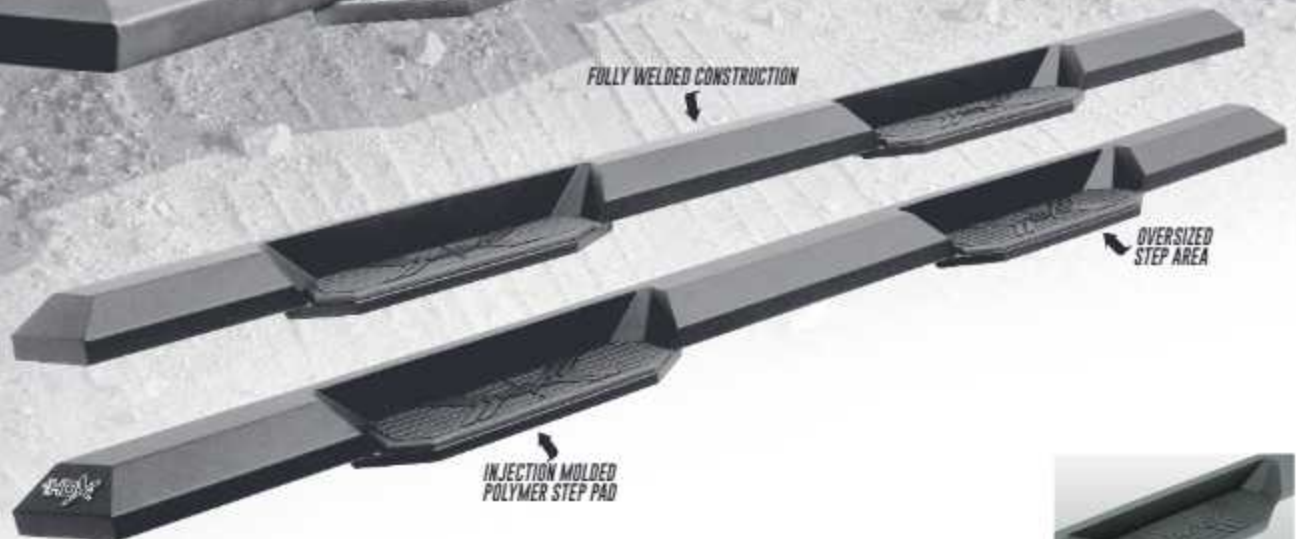

MOLDED POLYMER STEP PAD
REPLACEMENT P/N#
56-21001 (17.75")

START	END	MAKE	MODEL	TEXTURED BLACK
2015	2022	Chevrolet	Colorado Crew Cab	56-24019
2015	2022	Chevrolet	Colorado Ext. Cab	56-24006
2007	2018	Chevrolet	Silverado 1500 Crew Cab (Excl. 2007 Classic)	56-23729
2019	2023	Chevrolet	Silverado 1500 Crew Cab (Excl. 2019 LD)	56-24138
2019	2023	Chevrolet	Silverado 1500 Double Cab (Excl. 2019 LD)	56-24126
2007	2018	Chevrolet	Silverado 1500 Double Cab (Excl. 2007 Classic)	56-23716
2020	2023	Chevrolet	Silverado 2500/3500 Crew Cab	56-24134
2020	2023	Chevrolet	Silverado 2500/3500 Double Cab	56-24128
2007	2019	Chevrolet	Silverado 2500/3500HD Crew Cab (Excl. 2007 Classic)	56-23726
2007	2019	Chevrolet	Silverado 2500/3500HD Double Cab (Excl. 2007 Classic)	56-23718
2019	2019	Chevrolet	Silverado LD Double Cab (Excl. Classic)	56-23715
2009	2018	Dodge	Ram 1500 Crew Cab	56-23668
2009	2018	Dodge	Ram 1500 Quad Cab	56-23659
2010	2023	Dodge	Ram 2500/3500 Crew Cab ¹	56-23669
2015	2023	Ford	F-150 SuperCab	56-23935
2009	2014	Ford	F-150 SuperCrew	56-23926
2015	2023	Ford	F-150 SuperCrew	56-23945
2017	2023	Ford	F-250/350 Crew Cab	56-23945
2017	2023	Ford	F-250/350 SuperCab	56-23935
1999	2016	Ford	F-250/350/450/550 Crew Cab	56-21338
1999	2016	Ford	F-250/350/450/550 SuperCab	56-21316
2016	2023	Ford	Ranger SuperCab	56-24145
2016	2023	Ford	Ranger SuperCrew	56-24155
2016	2022	GMC	Canyon Crew Cab	56-24016

CONTINUED ON NEXT PAGE →

WESTiN[®] | NERF STEP BARS

HDX XTREME NERF STEP BARS CONTINUED TEXTURED BLACK

START	END	MAKE	MODEL	TEXTURED BLACK
2016	2022	GMC	Canyon Ext Cab	66-24006
2007	2018	GMC	Sierra 1500 Crew Cab (Excl. 2007 Classic)	66-23726
2019	2023	GMC	Sierra 1500 Crew Cab (Excl. 2019 Limited)	66-24139
2019	2023	GMC	Sierra 1500 Double Cab (Excl. 2019 Limited)	66-24128
2007	2018	GMC	Sierra 1500 Double Ext Cab (Excl. 2007 Classic)	66-23716
2019	2019	GMC	Sierra 1500 Limited Double Cab	66-23716
2020	2023	GMC	Sierra 2500-3500 Crew Cab	66-24139
2020	2023	GMC	Sierra 2500-3500 Double Cab	66-24128
2007	2019	GMC	Sierra 2500-3500HD Crew Cab	66-23726
2020	2023	Jeep	Gladator	66-24166
2007	2018	Jeep	Wrangler JK 2Dr	66-23316
2007	2018	Jeep	Wrangler JK Unlimited 4Dr	66-23296
2016	2023	Jeep	Wrangler JL 2Dr	66-24056
2016	2023	Jeep	Wrangler JL Unlimited 4Dr	66-24076
2017	2023	Nissan	Titan Crew Cab	66-24026
2016	2023	Nissan	Titan XD Crew Cab	66-24026
2016	2023	Ram	1500 Classic Crew Cab	66-23666
2019	2023	Ram	1500 Classic Quad Cab	66-23656
2009	2018	Ram	1500 Crew Cab	66-23666
2019	2023	Ram	1500 Crew Cab (Excl. Classic)	66-24086
2009	2018	Ram	1500 Quad Cab	66-23656
2019	2023	Ram	1500 Quad Cab (Excl. Classic)	66-24096
2010	2023	Ram	2500-3500 Crew Cab ¹	66-23666
2008	2023	Toyota	Tacoma Double Cab	66-22776
2007	2021	Toyota	Tundra CrewMax	66-23256

FOOTNOTES: 2. Excludes Chassis Cab With Diesel Exhaust Fluid (DEF) Tank Vehicles.



NERF STEP BARS

WESTIN®

R5 M-SERIES WHEEL-TO-WHEEL NERF STEP BARS 304 STAINLESS STEEL / TEXTURED BLACK

- Stylish Wheel-To-Wheel (W2W) length step bars
- Ships Parcel – lower cost than freight
- Protects vehicle rocker panels from potential damage
- Includes third step for easy truck bed access
- Injection molded polymer step pad
- 5" wide step area
- Rocker panel mounted
- Injection molded bracket covers included – on some applications
- Includes Westin exclusive isolator bracket & mount kit
- Registered U.S. Patent
- Optional light kit for end caps (part no. 28-51003)

3-PIECE MODULAR DESIGN

FINISH: Polished
MATERIAL: Stainless Steel
WARRANTY: Lifetime

FINISH: Textured Black Powder Coat
MATERIAL: E-Coated Steel
WARRANTY: 3-Year

THIRD STEP FOR EASY TRUCK BED ACCESS

5" WIDE STEP AREA

INJECTION MOLDED POLYMER STEP PAD



INCLUDES INJECTION MOLDED BRACKET COVERS



OPTIONAL LED LIGHT KIT
PN# 28-51003

WESTIN EXCLUSIVE ISOLATOR BRACKET



Westin's exclusive Isolator Bracket supports the step bar past the truck cab, which competitors do not offer. Our unique design provides extra bed support without annoying creaking sounds.

START	END	MAKE	MODEL	POLISHED	TEXTURED BLACK
2007	2018	Chevrolet	Silverado 1500 Crew Cab (5.8' Bed)(Excl. 2007 Classic)	—	28-514666
2019	2023	Chevrolet	Silverado 1500 Crew Cab (5.8' Bed)	28-514668	28-514668
2007	2018	Chevrolet	Silverado 1500 Crew Cab (5.5' Bed)(Excl. 2007 Classic)	28-514670	28-514670
2019	2023	Chevrolet	Silverado 1500 Crew Cab (5.5' Bed)(Excl. 2019 LD)	28-514690	28-514690
2007	2018	Chevrolet	Silverado 1500 Double Cab (6.5' Bed)(Excl. 2007 Classic)	28-514990	28-514990
2019	2023	Chevrolet	Silverado 1500 Double Cab (6.5' Bed)(Excl. 2019 LD)	28-514688	28-514688
2007	2018	Chevrolet	Silverado 1500 Ext Cab (5.5' Bed)(Excl. 2007 Classic)	28-514990	28-514990
2007	2019	Chevrolet	Silverado 2500/3500 Crew Cab (6.8' Bed) & Dually (8' Bed)	28-514970	28-514970
2007	2019	Chevrolet	Silverado 2500/3500 Crew Cab (8' Bed)(Excl. 2007 Classic)(Excl. Dually)	28-514980	28-514980
2007	2019	Chevrolet	Silverado 2500/3500 Double Cab (6.5' Bed) & Dually (8' Bed)(Excl. Classic)	28-514990	28-514990
2007	2019	Chevrolet	Silverado 2500/3500 Ext Cab (6.5' Bed) & Dually (8' Bed)(Excl. Classic)	28-514990	28-514990
2019	2019	Chevrolet	Silverado LD Double Cab (6.5' Bed)	28-514990	28-514990
2009	2018	Dodge	Ram 1500 Crew Cab (5.5' Bed)	28-514318	28-514318
2009	2018	Dodge	Ram 1500 Crew Cab (5.8' Bed)	28-514320	28-514320
2009	2018	Dodge	Ram 1500 Quad Cab (5.5' Bed)	28-514310	28-514310
2010	2018	Dodge	Ram 2500/3500 Crew Cab (5.8' Bed)	28-514320	28-514320
2010	2018	Dodge	Ram 2500/3500 Crew Cab (6.5' Bed) & Dually (8' Bed)	28-514320	28-514320
2010	2018	Dodge	Ram 2500/3500 Crew Cab (8' Bed)(Excl. Dually)	28-514330	28-514330
1999	2016	Ford	F-250/350/450/550 Crew Cab (6.75' Bed)	28-514010	28-514010
2007	2018	GMC	Sierra 1500 Crew Cab (5.8' Bed)(Excl. 2007 Classic)	—	28-514666
2019	2023	GMC	Sierra 1500 Crew Cab (5.8' Bed)	28-514688	28-514688
2007	2018	GMC	Sierra 1500 Crew Cab (5.5' Bed)(Excl. 2007 Classic)	28-514670	28-514670
2019	2023	GMC	Sierra 1500 Crew Cab (5.5' Bed)(Excl. 2019 Limited)	28-514690	28-514690

CONTINUED ON NEXT PAGE

R5 M-SERIES WHEEL-TO-WHEEL NERF STEP BARS *CONTINUED* 304 STAINLESS STEEL / TEXTURED BLACK ALUMINUM

START	END	MAKE	MODEL	POLISHED	TEXTURED BLACK
2007	2018	GMC	Sierra 1500 Double Cab (6.5' Bed)(Excl. 2007 Classic)	28-634890	28-634895
2019	2023	GMC	Sierra 1500 Double Cab (6.5' Bed)(Excl. 2019 Limited)	28-634880	28-634885
2007	2016	GMC	Sierra 1500 Ext Cab (6.5' Bed)(Excl. 2007 Classic)	28-634890	28-634895
2019	2019	GMC	Sierra 1500 Limited Double Cab (6.5' Bed)	28-634590	28-634595
2007	2019	GMC	Sierra 2500/3500 Crew Cab (6.5' Bed) & Dually (8' Bed)	28-634670	28-634675
2007	2019	GMC	Sierra 2500/3500 Crew Cab (8' Bed)(Excl. 2007 Classic)(Excl. Dually)	28-634580	28-634585
2007	2019	GMC	Sierra 2500/3500 Double Cab (6.5' Bed) & Dually (8' Bed)(Excl. 2007 Classic)	28-634890	28-634895
2007	2019	GMC	Sierra 2500/3500 Ext Cab (6.5' Bed) & Dually (8' Bed)(Excl. 2007 Classic)	28-634590	28-634595
2019	2023	Ram	1500 Classic Crew Cab (6.5' Bed)	28-634310	28-634315
2019	2023	Ram	1500 Classic Crew Cab (6.5' Bed)	28-634120	28-634125
2019	2023	Ram	1500 Classic Quad Cab (6.5' Bed)	28-634310	28-634315
2009	2018	Ram	1500 Crew Cab (5.5' Bed)	28-634210	28-634215
2019	2023	Ram	1500 Crew Cab (5.7' Bed)(Excl. Classic)	28-634700	28-634705
2009	2018	Ram	1500 Crew Cab (6.5' Bed)	28-634120	28-634125
2019	2023	Ram	1500 Crew Cab (6.5' Bed)(Excl. Classic)	28-634720	28-634725
2009	2018	Ram	1500 Quad Cab (6.5' Bed)	28-634210	28-634215
2019	2023	Ram	1500 Quad Cab (6.5' Bed)(Excl. Classic)	28-634730	28-634735
2010	2018	Ram	2500/3500 Crew Cab (6.5' Bed)	28-634120	28-634125
2019	2023	Ram	2500/3500 Crew Cab (6.5' Bed)	28-634780	28-634785
2010	2018	Ram	2500/3500 Crew Cab (6.5' Bed) & Dually (8' Bed)	28-634120	28-634125
2010	2018	Ram	2500/3500 Crew Cab (8' Bed)(Excl. Dually)	28-634330	28-634335
2019	2023	Ram	2500/3500 Crew Cab (8' Bed)(Excl. Dually)	28-634340	28-634345
2016	2023	Toyota	Tacoma Double Cab (6' Bed)	28-634180	28-634185

FOOTNOTES: 1. Requires Drilling.



NERF STEP BARS

WESTIN

R5 M-SERIES XD WHEEL-TO-WHEEL NERF STEP BARS 304 STAINLESS STEEL / TEXTURED BLACK ALUMINUM

- › Stylish Wheel-To-Wheel (W2W) length step bars
- › Provides lower step-up surface for safe and easy cab access
- › Protects vehicle rocker panels from potential damage
- › Extra drop is 3 inches lower to the ground
- › Modular design saves you money on shipping
- › Includes third step for easy truck bed access
- › Injection molded polymer step pad
- › 5" wide step area
- › Rocker panel mounted
- › Injection molded bracket covers included
- › Includes Westin exclusive isolator bracket and mount kit
- › Optional light kit for end caps (part no. 28-51003)
- › Registered U.S. Patent

FINISH: Polished
MATERIAL: 304 Stainless Steel
WARRANTY: Lifetime

FINISH: Textured Black Powder Coat
MATERIAL: Aluminum
WARRANTY: 3-Year

R5 M-SERIES: PARCEL FRIENDLY
**3-PIECE
 MODULAR
 DESIGN**

**EXTRA 3" OF DROP
 PROVIDES LOWER STEP-UP SURFACE
 FOR SAFE AND EASY CAB ACCESS**

**5" WIDE
 STEP AREA**

**INJECTION MOLDED
 POLYMER STEP PAD**

**TRIANGULAR INTERNAL BOARD
 DESIGN CONCEALS BRACKETS
 FOR A CLEAN LOOK**

**WESTIN EXCLUSIVE
 ISOLATOR BRACKET**



**OPTIONAL LED LIGHT KIT
 PN# 28-51003**



**MOLDED POLYMER STEP PAD
 REPLACEMENT PN#
 28-50001 (20.5") 28-50002 (28.5")**



Westin's exclusive Isolator Bracket supports the step bar post the truck cab, which competitors do not offer. Our unique design provides extra bed support without annoying creaking sounds.

START	END	MAKE	MODEL	POLISHED	TEXTURED BLACK
2020	2020	Chevrolet	Silverado 2500/3500 Crew Cab (5.8' Bed)	28-5234760	28-5234765
2020	2020	Chevrolet	Silverado 2500/3500 Crew Cab (8' Bed)	28-5234770	28-5234775
2020	2020	GMC	Sierra 2500/3500 Crew Cab (5.8' Bed)	28-5234760	28-5234765
2020	2020	GMC	Sierra 2500/3500 Crew Cab (8' Bed)	28-5234770	28-5234775

WESTIN[®] | NERF STEP BARS

R5 XD NERF STEP BARS 304 STAINLESS STEEL / TEXTURED BLACK ALUMINUM

- » Provides lower step-up surface for safe and easy cab access
- » Extra drop is 3 inches lower to the ground
- » Protects vehicle rocker panels from potential damage
- » Injection molded polymer step pad
- » 5" wide step area
- » Rocker panel mounted
- » Injection molded bracket covers included
- » Optional light kit for end caps (part no. 28-51003)
- » Registered U.S. Patent

FINISH: Polished

MATERIAL: 304 Stainless Steel

WARRANTY: Lifetime

FINISH: Textured Black

MATERIAL: Aluminum

WARRANTY: 3 Year

EXTRA 3" OF DROP
PROVIDES LOWER STEP-UP SURFACE
FOR SAFE AND EASY CAB ACCESS

5" WIDE
STEP AREA

INJECTION MOLDED
POLYMER STEP PAD



OPTIONAL LED LIGHT KIT
PN# 28-51003



MOLDED POLYMER STEP PAD
REPLACEMENT PN#
28-50001 (30.5") 28-50002 (28.5")

START	END	MAKE	MODEL	POLISHED	TEXTURED BLACK
2019	2023	Chevrolet	Silverado 1500 Crew Cab	28-521270	28-521278
2020	2023	Chevrolet	Silverado 2500/3500 Crew Cab	28-521270	28-521278
2009	2019	Dodge	Ram 1500 Crew Cab	28-521050	28-521055
2010	2023	Dodge	Ram 2500/3500 Crew Cab	28-521050	28-521055
2016	2023	Ford	F-150 SuperCrew	—	28-521095
2017	2023	Ford	F-250/350 Crew Cab	—	28-521095
2019	2023	GMC	Sierra 1500 Crew Cab	28-521270	28-521278
2020	2023	GMC	Sierra 2500/3500 Crew Cab	28-521270	28-521278
2009	2019	Ram	1500 Crew Cab	28-521050	28-521055
2019	2023	Ram	1500 Classic Crew Cab	28-521050	28-521055
2010	2023	Ram	2500-3500 Crew Cab	28-521050	28-521055

R5 NERF STEP BARS

304 STAINLESS STEEL / TEXTURED BLACK ALUMINUM

- ▶ Mount kit included
- ▶ Injection molded polymer step pad
- ▶ Protects vehicle rocker panels from potential damage
- ▶ 5" wide step area
- ▶ Triangular internal board design conceals brackets for a clean look
- ▶ Injection molded bracket covers included - on some applications
- ▶ Optional light kit for end caps (part no. 28-51003)

FINISH: Polished
MATERIAL: 304 Stainless Steel
WARRANTY: Lifetime

FINISH: Textured Black Powder Coat
MATERIAL: Aluminum
WARRANTY: 3-Year

5" WIDE
STEP AREA

TRIANGULAR INTERNAL BOARD
DESIGN CONCEALS BRACKETS
FOR A CLEAN LOOK

INCLUDES INJECTION MOLDED
BRACKET COVERS

OPTIONAL LED LIGHT KIT
PN# 28-51003

MOLDED POLYMER STEP PAD
REPLACEMENT PN#
28-50001 (30.5") 28-50002 (20.5")

START	END	MAKE	MODEL	BRACKET CVR	LENGTH (IN)	POLISHED	TEXTURED BLACK
2016	2023	Chevrolet	Colorado Crew Cab	Yes	77	28-51010	28-51015
2016	2022	Chevrolet	Colorado Ext Cab	Yes	87	28-51000	28-51005
2007	2018	Chevrolet	Silverado 1500 Crew Cab (Excl. 2007 Classic)	Yes	87	28-51030	28-51035
2019	2023	Chevrolet	Silverado 1500 Crew Cab	Yes	87	28-51279	28-51279
2019	2023	Chevrolet	Silverado 1500 Double Cab (Excl. 2019 LD)	Yes	77	28-51260	28-51265
2007	2018	Chevrolet	Silverado 1500 Double/Ext Cab (Excl. 2007 Classic)	Yes	77	28-51020	28-51025
2007	2019	Chevrolet	Silverado 2500/3500HD Crew Cab (Excl. 2007 Classic)	Yes	87	28-51030	28-51035
2020	2023	Chevrolet	Silverado 2500/3500 Crew Cab	Yes	87	28-51279	28-51279
2007	2019	Chevrolet	Silverado 2500/3500HD Double/Ext Cab (Excl. 2007 Classic)	Yes	77	28-51020	28-51025
2020	2023	Chevrolet	Silverado 2500/3500 Double Cab	Yes	77	28-51260	28-51265
2019	2019	Chevrolet	Silverado LD Double Cab	Yes	77	28-51020	28-51025
2009	2018	Dodge	Ram 1500 Crew Cab	Yes	86	28-51050	28-51055
2009	2018	Dodge	Ram 1500 Quad Cab	Yes	76	28-51040	28-51045
2010	2023	Dodge	Ram 2500/3500 Crew Cab ¹	Yes	86	28-51050	28-51055
2020	2023	Ford	Explorer	Yes	81	28-51250	28-51255
2016	2023	Ford	F-150 SuperCab	Yes	76	28-51000	28-51005
2016	2023	Ford	F-150 SuperCrew	Yes	90	28-51090	28-51095
2017	2023	Ford	F-250/350 Crew Cab	Yes	90	28-51090	28-51095
2017	2023	Ford	F-250/350 SuperCab	Yes	76	28-51000	28-51005
2019	2023	Ford	Ranger SuperCab	Yes	87	—	28-51005
2019	2023	Ford	Ranger SuperCrew	Yes	—	28-51290	28-51295
2016	2023	GMC	Canyon Crew Cab	Yes	77	28-51010	28-51015

CONTINUED ON NEXT PAGE

R5 NERF STEP BARS CONTINUED

304 STAINLESS STEEL / TEXTURED BLACK ALUMINUM

START	END	MAKE	MODEL	BRACKET CVR	LENGTH (IN)	POLISHED	TEXTURED BLACK
2016	2023	GMC	Canyon Ext Cab	Yes	67	28-51000	28-51009
2007	2018	GMC	Sierra 1500 Crew Cab (Excl. 2007 Classic)	Yes	67	28-51030	28-51039
2019	2023	GMC	Sierra 1500 Crew Cab	Yes	67	28-51270	28-51279
2019	2023	GMC	Sierra 1500 Double Cab (Excl. 2019 Limited)	Yes	77	28-51260	28-51269
2007	2018	GMC	Sierra 1500 Double Ext Cab (Excl. 2007 Classic)	Yes	77	28-51020	28-51029
2019	2019	GMC	Sierra 1500 Limited Double Cab	Yes	77	28-51020	28-51029
2007	2019	GMC	Sierra 2500/3500HD Crew Cab (Excl. 2007 Classic)	Yes	67	28-51030	28-51039
2020	2023	GMC	Sierra 2500/3500 Crew Cab	Yes	67	28-51270	28-51279
2007	2019	GMC	Sierra 2500/3500HD Double Ext Cab (Excl. 2007 Classic)	Yes	77	28-51020	28-51029
2020	2023	GMC	Sierra 2500/3500 Double Cab	Yes	77	28-51260	28-51269
2020	2023	Jeep	Gladator	No	—	—	28-51329
2018	2023	Jeep	Wrangler JL Unlimited 4Dr	No	—	—	28-51319
2005	2021	Nissan	Frontier Crew Cab	Yes	60	28-51170	28-51179
2005	2021	Nissan	Frontier Ext King Cab	Yes	67	28-51180	28-51189
2017	2023	Nissan	Titan Crew Cab	Yes	67	28-51160	28-51169
2016	2023	Nissan	Titan XD Crew Cab	Yes	67	28-51160	28-51169
2019	2023	Ram	1500 Classic Crew Cab	Yes	65	28-51040	28-51049
2019	2023	Ram	1500 Classic Quad Cab	Yes	76	28-51040	28-51049
2009	2019	Ram	1500 Crew Cab	Yes	65	28-51030	28-51039
2019	2023	Ram	1500 Crew Cab (Excl. Classic)	Yes	65	28-51220	28-51229
2009	2018	Ram	1500 Quad Cab	Yes	76	28-51040	28-51049
2019	2023	Ram	1500 Quad Cab (Excl. Classic)	Yes	65	28-51230	28-51239
2010	2023	Ram	2500/3500 Crew Cab 2	Yes	65	28-51050	28-51059
2010	2019	Toyota	4Runner (Excl. Trail)	Yes	66	28-51200	28-51209
2010	2023	Toyota	4Runner Limited Nightshade/TRD Sport (Excl. 40th Anni/SR5 & Premium/TRD Off-Road & Pro/Trail/Venture)	Yes	66	28-51200	28-51209
2014	2023	Toyota	4Runner Limited Nightshade/TRD Sport (Excl. 40th Anni/SR5 & Premium/TRD Off-Road & Pro/Trail/Venture (Excl. Limited/Nightshade/TRD Sport)	Yes	67	28-51190	28-51199
2010	2017	Toyota	4Runner Trail (Excl. Limited & Nightshade)	Yes	67	28-51190	28-51199
2006	2023	Toyota	Tacoma Access Cab	Yes	68	—	28-51129
2005	2023	Toyota	Tacoma Double Cab	Yes	60	28-51130	28-51139
2007	2021	Toyota	Tundra CrewMax	Yes	94	28-51150	28-51159
2022	2023	Toyota	Tundra CrewMax	Yes	86	28-51340	28-51349
2007	2021	Toyota	Tundra Double Cab	Yes	81	28-51140	28-51149
2022	2023	Toyota	Tundra Double Cab	Yes	76	28-51330	28-51339

FOOTNOTES: 2. Excludes Chassis Cab With Diesel Exhaust Fluid (DEF) Tank Vehicles



NERF STEP BARS

WESTIN

PRO TRAXX 4 OVAL NERF STEP BARS

304 STAINLESS STEEL / BLACK POWDER COAT

- › Mount kit included
- › 4" oval tube
- › Protects vehicle rocker panels from potential damage
- › 30" factory style bends at each end of the tube
- › Fully welded domed ends
- › Injection molded polymer step pad
- › Injection molded bracket covers included - on some applications
- › 4" wide step area with Westin logo
- › Bolt-on installation - no drilling required on most applications

FINISH: Polished
MATERIAL: 304 Stainless Steel
WARRANTY: Lifetime

FINISH: Black Powder Coat
MATERIAL: E-Coated Steel
WARRANTY: 3-Year



INCLUDES INJECTION MOLDED BRACKET COVERS



MOLDED POLYMER STEP PAD
 REPLACEMENT PN#
 21-20001 (6 STUD), 21-20002-5 (5 STUD)

START	END	MAKE	MODEL	BRACKET CVR	MOUNTING	POLISHED	BLACK
2015	2023	Chevrolet	Colorado Crew Cab (Incl. Diesel)	No	Rocker Pnl	21-24010	21-24015
2015	2022	Chevrolet	Colorado Ext Cab (Incl. Diesel)	Yes	Rocker Pnl	21-24000	21-24005
2007	2013	Chevrolet	Silverado 1500 Crew Cab (Excl. 2007 Classic)	Yes	Rocker Pnl	21-21980	21-21985
2014	2018	Chevrolet	Silverado 1500 Crew Cab (Incl. Diesel)	Yes	Rocker Pnl	21-23720	21-23725
2019	2023	Chevrolet	Silverado 1500 Crew Cab	Yes	Rocker Pnl	21-24130	21-24135
2014	2018	Chevrolet	Silverado 1500 Double Cab	Yes	Rocker Pnl	21-23710	21-23715
2019	2023	Chevrolet	Silverado 1500 Double Cab (Excl. 2019 LD)	Yes	Rocker Pnl	21-24120	21-24125
2007	2013	Chevrolet	Silverado 1500 Ext Cab (Excl. 2007 Classic)	Yes	Rocker Pnl	21-21680	21-21685
2007	2013	Chevrolet	Silverado 1500 Reg Cab (Excl. 2007 Classic)	Yes	Rocker Pnl	21-21400	21-21405
2014	2018	Chevrolet	Silverado 1500 Reg Cab	No	Rocker Pnl	21-23700	21-23705
2019	2023	Chevrolet	Silverado 1500 Reg Cab	Yes	Rocker Pnl	21-24110	21-24115
2020	2023	Chevrolet	Silverado 2500/3500 Crew Cab	Yes	Rocker Pnl	21-24130	21-24135
2020	2023	Chevrolet	Silverado 2500/3500 Double Cab	Yes	Rocker Pnl	21-24120	21-24125
2020	2023	Chevrolet	Silverado 2500/3500 Reg Cab	Yes	Rocker Pnl	21-24110	21-24115
2007	2010	Chevrolet	Silverado 2500/3500HD	Yes	Rocker Pnl	21-21680	21-21685
2011	2014	Chevrolet	Silverado 2500/3500HD Crew Cab (Excl. 2007 Classic)(Excl. Diesel)	Yes	Rocker Pnl	21-21950	21-21955
2015	2019	Chevrolet	Silverado 2500/3500HD Crew Cab (Incl. Diesel)	Yes	Rocker Pnl	21-23720	21-23725
2015	2019	Chevrolet	Silverado 2500/3500HD Double Cab (Incl. Diesel)	Yes	Rocker Pnl	21-23700	—
2015	2019	Chevrolet	Silverado 2500/3500HD Double Cab (Incl. Diesel)	Yes	Rocker Pnl	21-23710	21-23715
2011	2014	Chevrolet	Silverado 2500/3500HD Ext Cab (Excl. 2007 Classic)(Excl. Diesel)	Yes	Rocker Pnl	21-21680	21-21685
2007	2014	Chevrolet	Silverado 2500/3500HD Reg Cab (Excl. 2007 Classic)(Excl. 2011-2014 Diesel)	Yes	Rocker Pnl	21-21400	21-21405
2015	2019	Chevrolet	Silverado 2500/3500HD Reg Cab (Excl. Diesel)	Yes	Rocker Pnl	21-23700	21-23705

CONTINUED ON NEXT PAGE

PRO TRAXX 4 OVAL NERF STEP BARS CONTINUED

304 STAINLESS STEEL / BLACK POWDER COAT

START	END	MAKE	MODEL	BRACKET CVR	MOUNTING	POLISHED	BLACK
2015	2019	Chevrolet	Silverado 2500/3500HD Reg Cab (Incl. Diesel)	Yes	Rocker Pkt	21-23840	—
2019	2019	Chevrolet	Silverado LD Double Cab	Yes	Rocker Pkt	21-23710	21-23710
2009	2016	Dodge	Ram 1500 Crew Cab	Yes	Rocker Pkt	21-23560	21-23565
2009	2016	Dodge	Ram 1500 Quad Cab	Yes	Rocker Pkt	21-23550	21-23555
2010	2023	Dodge	Ram 2500/3500 Crew Cab ⁷	No	Rocker Pkt	21-23660	21-23665
2021	2023	Ford	Bronco 2Dr (Excl. Bronco Sport)	Yes	Rocker Pkt	21-24180	21-24185
2021	2023	Ford	Bronco 4Dr (Excl. Bronco Sport [™])	Yes	Rocker Pkt	21-24190	21-24195
2020	2023	Ford	Explorer [®]	Yes	Rocker Pkt	21-24170	21-24175
2009	2014	Ford	F-150 SuperCab (Excl. Harley Davidson & Raptor)	Yes	Rocker Pkt	21-23510	21-23515
2015	2023	Ford	F-150 SuperCab	Yes	Rocker Pkt	21-23930	21-23935
2009	2014	Ford	F-150 SuperCrew (Excl. Harley Davidson & Raptor)	Yes	Rocker Pkt	21-23520	21-23525
2016	2023	Ford	F-150 SuperCrew	Yes	Rocker Pkt	21-23940	21-23945
2017	2023	Ford	F-250/350 Crew Cab	Yes	Rocker Pkt	21-23940	21-23945
2017	2023	Ford	F-250/350 SuperCab	Yes	Rocker Pkt	21-23930	21-23935
1999	2016	Ford	F-250/350/450/550 Crew Cab	Yes	Rocker Pkt	21-21330	21-21335
1999	2016	Ford	F-250/350/450/550 SuperCab	Yes	Rocker Pkt	21-21210	21-21215
2019	2023	Ford	Ranger SuperCab	Yes	Rocker Pkt	21-24140	21-24145
2019	2023	Ford	Ranger SuperCrew	Yes	Rocker Pkt	21-24150	21-24155
2016	2023	GMC	Canyon Crew Cab (Incl. Diesel)	Yes	Rocker Pkt	21-24010	21-24015
2016	2023	GMC	Canyon Ext Cab (Incl. Diesel)	Yes	Rocker Pkt	21-24000	21-24005
2007	2015	GMC	Sierra 1500 Crew Cab (Excl. 2007 Classic)	Yes	Rocker Pkt	21-21950	21-21955
2014	2016	GMC	Sierra 1500 Crew Cab (Incl. Diesel)	Yes	Rocker Pkt	21-23720	21-23725
2019	2023	GMC	Sierra 1500 Crew Cab (Excl. 2019 Limited)	Yes	Rocker Pkt	21-24130	21-24135
2014	2016	GMC	Sierra 1500 Double Cab	Yes	Rocker Pkt	21-23710	21-23715
2019	2023	GMC	Sierra 1500 Double Cab (Excl. 2019 Limited)	Yes	Rocker Pkt	21-24120	21-24125
2007	2015	GMC	Sierra 1500 Ext Cab (Excl. 2007 Classic)	Yes	Rocker Pkt	21-21680	21-21685
2019	2019	GMC	Sierra 1500 Limited Double Cab	Yes	Rocker Pkt	21-23710	21-23715
2007	2019	GMC	Sierra 1500 Reg Cab (Excl. 2007 Classic)	Yes	Rocker Pkt	21-21400	21-21405
2014	2016	GMC	Sierra 1500 Reg Cab	No	Rocker Pkt	21-23700	21-23705
2019	2023	GMC	Sierra 1500 Reg Cab	Yes	Rocker Pkt	21-24110	21-24115
2020	2023	GMC	Sierra 2500/3500 Crew Cab	Yes	Rocker Pkt	21-24130	21-24135
2020	2023	GMC	Sierra 2500/3500 Double Cab	Yes	Rocker Pkt	21-24120	21-24125
2020	2023	GMC	Sierra 2500/3500 Reg Cab	Yes	Rocker Pkt	21-24110	21-24115
2007	2010	GMC	Sierra 2500/3500HD (Incl. Diesel)	Yes	Rocker Pkt	21-21690	21-21695
2011	2014	GMC	Sierra 2500/3500HD Crew Cab (Excl. 2007 Classic)(Excl. Diesel)	Yes	Rocker Pkt	21-21960	21-21965
2016	2019	GMC	Sierra 2500/3500HD Crew Cab (Incl. Diesel)	Yes	Rocker Pkt	21-23730	21-23735
2016	2019	GMC	Sierra 2500/3500HD Double Cab (Incl. Diesel)	Yes	Rocker Pkt	21-23850	—
2016	2019	GMC	Sierra 2500/3500HD Double Cab (Incl. Diesel)	Yes	Rocker Pkt	21-23710	21-23715
2011	2014	GMC	Sierra 2500/3500HD Ext Cab (Excl. 2007 Classic)(Excl. Diesel)	Yes	Rocker Pkt	21-21680	21-21685
2007	2014	GMC	Sierra 2500/3500HD Reg Cab (Excl. 2007 Classic)(Excl. 2011-2014 Diesel)	Yes	Rocker Pkt	21-21400	21-21405
2016	2019	GMC	Sierra 2500/3500HD Reg Cab (Excl. Diesel)	Yes	Rocker Pkt	21-23700	21-23705
2016	2019	GMC	Sierra 2500/3500HD Reg Cab (Incl. Diesel)	Yes	Rocker Pkt	21-23840	—
2020	2023	Jeep	Gladator	Yes	Rocker Pkt	21-24160	21-24165
2007	2018	Jeep	Wrangler JK 2Dr	Yes	Rocker Pkt	21-23310	21-23315
2007	2018	Jeep	Wrangler JK Unlimited 4Dr	No	Rocker Pkt	21-23290	21-23295
2018	2023	Jeep	Wrangler JL 2Dr	No	Rocker Pkt	21-24080	21-24085
2018	2023	Jeep	Wrangler JL Unlimited 4Dr	No	Rocker Pkt	21-24060	21-24065
2022	2023	Nissan	Frontier Crew Cab	Yes	Rocker Pkt	21-24210	21-24215
2017	2023	Nissan	Titan Crew Cab	No	Rocker Pkt	21-24020	21-24025
2016	2023	Nissan	Titan XD Crew Cab	Yes	Rocker Pkt	21-24020	21-24025
2016	2023	Ram	1500 Classic Crew Cab	Yes	Rocker Pkt	21-23560	21-23565
2019	2023	Ram	1500 Classic Quad Cab	Yes	Rocker Pkt	21-23550	21-23555
2009	2016	Ram	1500 Crew Cab	Yes	Rocker Pkt	21-23560	21-23565
2019	2023	Ram	1500 Crew Cab (Excl. Classic)	Yes	Rocker Pkt	21-24080	21-24085
2009	2016	Ram	1500 Quad Cab	Yes	Rocker Pkt	21-23550	21-23555
2019	2023	Ram	1500 Quad Cab (Excl. Classic)	Yes	Rocker Pkt	21-24090	21-24095
2010	2023	Ram	2500/3500 Crew Cab ⁷	Yes	Rocker Pkt	21-23660	21-23665
2010	2023	Toyota	4Runner Limited/Nightside/TRD Sport (Excl. 40th Anniversary & Premium/TRD Off-Road & Pro-Traill/Venture)	Yes	Rocker Pkt	21-23680	21-23685
2010	2019	Toyota	4Runner SR5 (Excl. Trail)	Yes	Rocker Pkt	21-23680	21-23685
2014	2023	Toyota	4Runner 40th Anniversary & Premium/TRD Off-Road & Pro-Traill/Venture (Excl. Limited/Nightside/TRD Sport)	Yes	Rocker Pkt	21-23630	21-23635
2010	2017	Toyota	4Runner Trail (Excl. Limited)	Yes	Rocker Pkt	21-23630	21-23635
2005	2023	Toyota	Tacoma Access Cab	Yes	Rocker Pkt	21-22670	21-22675
2005	2023	Toyota	Tacoma Double Cab	No	Rocker Pkt	21-22770	21-22775
2007	2021	Toyota	Tundra CrewMax	Yes	Rocker Pkt	21-24250	21-24255
2022	2023	Toyota	Tundra CrewMax	Yes	Rocker Pkt	21-24230	21-24235
2007	2021	Toyota	Tundra Double Cab	Yes	Rocker Pkt	21-23240	21-23245
2022	2023	Toyota	Tundra Double Cab	Yes	Rocker Pkt	21-24220	21-24225

FOOTNOTES: 7. Excludes Chassis Cab With Diesel Exhaust Fluid (DEF) Tank Vehicles. 8. No Drilling Required. 100. Requires Removal Of Rock Sliders If Equipped.



PRO TRAXX 5 OVAL NERF STEP BARS

304 STAINLESS STEEL / BLACK POWDER COAT

- ▶ Mount kit included
- ▶ 5" oval tube
- ▶ Protects vehicle rocker panels from potential damage
- ▶ 30" factory style bends at each end of the tube
- ▶ Fully welded domed ends
- ▶ Injection molded polymer step pad
- ▶ Injection molded bracket covers included - on some applications
- ▶ 5" wide step area with Westin logo
- ▶ Bolt-on installation - no drilling required on most applications

FINISH: Polished
MATERIAL: 304 Stainless Steel
WARRANTY: Lifetime

FINISH: Black Powder Coat
MATERIAL: E-Coated Steel
WARRANTY: 3-Year



INCLUDES INJECTION MOLDED BRACKET COVERS



MOLDED POLYMER STEP PAD
REPLACEMENT P/N#
21-50001 (24") 21-50002 (24")

START	END	MAKE	MODEL	BRACKET CVR	MOUNTING	POLISHED	BLACK
2015	2025	Chevrolet	Colorado Crew Cab (Incl. Diesel)	Yes	Rocker Pnl	21-54010	21-54015
2015	2022	Chevrolet	Colorado Ext Cab (Incl. Diesel)	Yes	Rocker Pnl	21-54000	21-54005
2020	2025	Chevrolet	Silverado 2500/3500 Double Cab	Yes	Rocker Pnl	21-54120	21-54125
2007	2013	Chevrolet	Silverado 1500 Crew Cab (Excl. 2007 Classic)	Yes	Rocker Pnl	21-51950	21-51955
2014	2018	Chevrolet	Silverado 1500 Crew Cab	Yes	Rocker Pnl	21-53720	21-53725
2019	2025	Chevrolet	Silverado 1500 Crew Cab (Excl. 2019 LD)	Yes	Rocker Pnl	21-54100	21-54105
2014	2018	Chevrolet	Silverado 1500 Double Cab	Yes	Rocker Pnl	21-53710	21-53715
2019	2025	Chevrolet	Silverado 1500 Double Cab (Excl. 2019 LD)	Yes	Rocker Pnl	21-54120	21-54125
2007	2013	Chevrolet	Silverado 1500 Ext Cab (Excl. 2007 Classic)	Yes	Rocker Pnl	21-51680	21-51685
2007	2013	Chevrolet	Silverado 1500 Reg Cab (Excl. 2007 Classic)	Yes	Rocker Pnl	21-51400	—
2014	2018	Chevrolet	Silverado 1500 Reg Cab	Yes	Rocker Pnl	—	21-53705
2020	2025	Chevrolet	Silverado 2500/3500 Crew Cab	Yes	Rocker Pnl	21-54120	21-54125
2011	2014	Chevrolet	Silverado 2500/3500HD Crew Cab (Excl. Diesel)	Yes	Rocker Pnl	21-51950	21-51955
2015	2019	Chevrolet	Silverado 2500/3500HD Crew Cab (Incl. Diesel)	Yes	Rocker Pnl	21-53720	21-53725
2015	2019	Chevrolet	Silverado 2500/3500HD Double Cab (Incl. Diesel)	Yes	Rocker Pnl	21-53710	21-53715
2011	2014	Chevrolet	Silverado 2500/3500HD Ext Cab (Excl. Diesel)	Yes	Rocker Pnl	21-51680	21-51685
2011	2014	Chevrolet	Silverado 2500/3500HD Reg Cab (Excl. Diesel)	Yes	Rocker Pnl	21-51400	—
2015	2019	Chevrolet	Silverado 2500/3500HD Reg Cab (Incl. Diesel)	Yes	Rocker Pnl	—	21-53705
2015	2019	Chevrolet	Silverado 2500/3500HD Reg Cab (Incl. Diesel)	Yes	Rocker Pnl	21-53840	21-53845
2019	2019	Chevrolet	Silverado LD Double Cab	Yes	Rocker Pnl	21-53710	21-53715
2009	2015	Dodge	Ram 1500 Crew Cab	Yes	Rocker Pnl	21-53560	21-53565
2009	2015	Dodge	Ram 1500 Quad Cab	Yes	Rocker Pnl	21-53550	21-53555

CONTINUED ON NEXT PAGE

PRO TRAXX 5 OVAL NERF STEP BARS CONTINUED

304 STAINLESS STEEL / BLACK POWDER COAT

START	END	MAKE	MODEL	BRACKET CVR	MOUNTING	POLISHED	BLACK
2010	2023	Dodge	Ram 2500/3500 Crew Cab 7	Yes	Rocker Pnl	21-53960	21-53969
2021	2023	Ford	Bronco 4Dr (Excl. Bronco Sport)™	Yes	Rocker Pnl	—	21-54195
2020	2023	Ford	Explorer*	Yes	Rocker Pnl	21-54170	21-54175
2009	2014	Ford	F-150 SuperCab (Excl. Harley Davidson & Raptor)	Yes	Rocker Pnl	—	21-53916
2016	2023	Ford	F-150 SuperCab	Yes	Rocker Pnl	21-53910	21-53919
2009	2014	Ford	F-150 SuperCrew (Excl. Harley Davidson & Raptor)	Yes	Rocker Pnl	21-53920	21-53929
2016	2023	Ford	F-150 SuperCrew	Yes	Rocker Pnl	21-53940	21-53949
2017	2023	Ford	F-250/350 Crew Cab	Yes	Rocker Pnl	21-53940	21-53949
2017	2023	Ford	F-250/350 SuperCab	Yes	Rocker Pnl	21-53910	21-53919
1999	2016	Ford	F-250/350/450/550 Crew Cab	Yes	Rocker Pnl	21-51330	21-51339
1999	2016	Ford	F-250/350/450/550 SuperCab	Yes	Rocker Pnl	21-51310	21-51319
2019	2023	Ford	Ranger SuperCab	Yes	Rocker Pnl	21-54140	21-54149
2019	2023	Ford	Ranger SuperCrew	Yes	Rocker Pnl	21-54150	21-54159
2016	2023	GMC	Canyon Crew Cab (Incl. Diesel)	Yes	Rocker Pnl	21-54010	21-54019
2016	2022	GMC	Canyon Ext Cab (Incl. Diesel)	Yes	Rocker Pnl	21-54000	21-54009
2007	2010	GMC	Sierra 1500 Crew Cab (Excl. 2007 Classic)	Yes	Rocker Pnl	21-51960	21-51969
2014	2018	GMC	Sierra 1500 Crew Cab	Yes	Rocker Pnl	21-53720	21-53729
2019	2023	GMC	Sierra 1500 Crew Cab (Excl. 2019 Limited)	Yes	Rocker Pnl	21-54130	21-54139
2014	2018	GMC	Sierra 1500 Double Cab	Yes	Rocker Pnl	21-53710	21-53719
2019	2023	GMC	Sierra 1500 Double Cab (Excl. 2019 Limited)	Yes	Rocker Pnl	21-54120	21-54129
2007	2013	GMC	Sierra 1500 Ext Cab (Excl. 2007 Classic)	Yes	Rocker Pnl	21-51680	21-51689
2019	2019	GMC	Sierra 1500 Limited Double Cab	Yes	Rocker Pnl	21-53710	21-53719
2007	2013	GMC	Sierra 1500 Reg Cab (Excl. 2007 Classic)	Yes	Rocker Pnl	21-51400	—
2014	2018	GMC	Sierra 1500 Reg Cab	Yes	Rocker Pnl	—	21-53709
2020	2023	GMC	Sierra 2500/3500 Crew Cab	Yes	Rocker Pnl	21-54130	21-54139
2020	2023	GMC	Sierra 2500/3500 Double Cab	Yes	Rocker Pnl	21-54120	21-54129
2011	2014	GMC	Sierra 2500/3500HD Crew Cab (Excl. Diesel)	Yes	Rocker Pnl	21-51960	21-51969
2016	2019	GMC	Sierra 2500/3500HD Crew Cab (Incl. Diesel)	Yes	Rocker Pnl	21-53720	21-53729
2016	2019	GMC	Sierra 2500/3500HD Double Cab (Incl. Diesel)	Yes	Rocker Pnl	21-53710	21-53719
2011	2014	GMC	Sierra 2500/3500HD Ext Cab (Excl. Diesel)	Yes	Rocker Pnl	21-51680	21-51689
2011	2014	GMC	Sierra 2500/3500HD Reg Cab (Excl. Diesel)	Yes	Rocker Pnl	21-51400	—
2016	2019	GMC	Sierra 2500/3500HD Reg Cab (Incl. Diesel)	Yes	Rocker Pnl	—	21-53709
2016	2019	GMC	Sierra 2500/3500HD Reg Cab (Incl. Diesel)	Yes	Rocker Pnl	21-53840	21-53849
2020	2023	Jeep	Gladiator	No	Rocker Pnl	21-54160	21-54169
2016	2023	Jeep	Wrangler JL Unlimited 4Dr	No	Rocker Pnl	21-54060	21-54069
2017	2023	Nissan	Titan Crew Cab	Yes	Rocker Pnl	21-54020	21-54029
2016	2023	Nissan	Truck XD Crew Cab	Yes	Rocker Pnl	21-54020	21-54029
2019	2023	Ram	1500 Classic Crew Cab	Yes	Rocker Pnl	21-53960	21-53969
2019	2023	Ram	1500 Classic Quad Cab	Yes	Rocker Pnl	21-53550	21-53559
2009	2018	Ram	1500 Crew Cab	Yes	Rocker Pnl	21-53960	21-53969
2019	2023	Ram	1500 Crew Cab (Excl. Classic)	Yes	Rocker Pnl	21-54080	21-54089
2009	2018	Ram	1500 Quad Cab	Yes	Rocker Pnl	21-53960	21-53969
2019	2023	Ram	1500 Quad Cab (Excl. Classic)	Yes	Rocker Pnl	21-54090	21-54099
2010	2023	Ram	2500/3500 Crew Cab 7	Yes	Rocker Pnl	21-53960	21-53969
2010	2023	Toyota	4Runner Limited Nightshade TRD Sport (Excl. 40th Anniversary & Premium TRD Off-Road & Pro-Trail Venture)	Yes	Rocker Pnl	21-53680	21-53689
2010	2019	Toyota	4Runner SR5 (Excl. Trail)	Yes	Rocker Pnl	21-53680	21-53689
2014	2023	Toyota	4Runner 40th Anniversary SR5 & Premium TRD Off-Road & Pro-Trail Venture (Excl. Limited Nightshade TRD Sport)	Yes	Rocker Pnl	21-53610	21-53619
2010	2017	Toyota	4Runner Trail (Excl. Limited)	Yes	Rocker Pnl	21-53830	21-53839
2005	2023	Toyota	Tacoma Double Cab	Yes	Rocker Pnl	21-52770	21-52779
2007	2021	Toyota	Tundra CrewMax	Yes	Rocker Pnl	21-53250	21-53259
2007	2021	Toyota	Tundra Double Cab	Yes	Rocker Pnl	21-53240	21-53249

FOOTNOTES: 7. Excludes Chassis Cab With Diesel Exhaust Fluid (DEF) Tank Vehicles. 8. No Drilling Required. 196. Requires Removal Of Rock Sliders If Equipped.



PRO TRAXX 5 OVAL WHEEL-TO-WHEEL NERF STEP BARS

304 STAINLESS STEEL / BLACK POWDER COAT

- ▶ Mount kit included
- ▶ Wheel-To-Wheel (W2W) length step bars
- ▶ Protects vehicle rocker panels from potential damage
- ▶ 5" oval tube
- ▶ Third step for easy truck bed access
- ▶ 30° factory style bends at each end of the tube
- ▶ Fully welded domed ends
- ▶ Isolator bracket included - on some applications
- ▶ Injection molded polymer step pad
- ▶ Injection molded bracket covers included - on some applications
- ▶ Bolt-on installation - no drilling required on most applications

FINISH: Polished

MATERIAL: 304 Stainless Steel

WARRANTY: Lifetime

FINISH: Black Powder Coat

MATERIAL: E-Coated Steel

WARRANTY: 3-Year



WESTIN EXCLUSIVE ISOLATOR BRACKET



Westin's exclusive Isolator Bracket supports the step bar past the truck cab, which competitors do not offer. Our unique design provides extra bed support without annoying creaking sounds.



INCLUDES INJECTION MOLDED BRACKET COVERS



MOLDED POLYMER STEP PAD REPLACEMENT PART
21-50001 (24") 21-50002 (14")

START	END	MAKE	MODEL	BRACKET CVR	ISOLATOR INCLUDED	POLISHED	BLACK
2007	2018	Chevrolet	Silverado 1500 Crew Cab (6.5' Bed)(Excl. 2007 Classic)	Yes	No	21-534860	21-534865
2019	2020	Chevrolet	Silverado 1500 Crew Cab (6.5' Bed)(Excl. 2019 LD)	Yes	No	21-534680	21-534685
2007	2018	Chevrolet	Silverado 1500 Crew Cab (6.5' Bed)	Yes	Yes	21-534570	21-534575
2019	2020	Chevrolet	Silverado 1500 Crew Cab (6.5' Bed)(Excl. 2019 LD)	Yes	Yes	21-534690	21-534695
2007	2018	Chevrolet	Silverado 1500 Double Cab (6.5' Bed)	Yes	Yes	21-534590	21-534595
2019	2020	Chevrolet	Silverado 1500 Double Cab (6.5' Bed)(Excl. 2019 LD)	Yes	Yes	21-534710	21-534715
2007	2018	Chevrolet	Silverado 1500 Ext Cab (6.5' Bed)(Excl. 2007 Classic)	Yes	Yes	21-534590	21-534595
2007	2019	Chevrolet	Silverado 1500 Ext Cab (8' Bed)(Excl. 2007 Classic)(Excl. Dually)	Yes	Yes	21-534600	21-534605
2020	2020	Chevrolet	Silverado 2500/3500 Crew Cab (6.5' Bed)	Yes	Yes	21-534760	21-534765
2020	2020	Chevrolet	Silverado 2500/3500 Crew Cab (8' Bed)	Yes	Yes	21-534770	21-534775
2020	2020	Chevrolet	Silverado 2500/3500 Double Cab (8' Bed)	Yes	Yes	21-534780	21-534785
2007	2019	Chevrolet	Silverado 2500/3500HD Crew Cab (6.5' Bed) & Dually (8' Bed)(Excl. 2007 Classic)	Yes	Yes	21-534870	21-534875
2007	2019	Chevrolet	Silverado 2500/3500HD Crew Cab (8' Bed)(Excl. 2007 Classic)(Excl. Dually)	Yes	Yes	21-534880	21-534885
2007	2019	Chevrolet	Silverado 2500/3500HD Double Cab (6.5' Bed) & Dually (8' Bed)	Yes	Yes	21-534590	21-534595
2007	2019	Chevrolet	Silverado 2500/3500HD Double Cab (8' Bed)(Excl. Dually)	Yes	Yes	21-534600	21-534605
2007	2019	Chevrolet	Silverado 2500/3500HD Ext Cab (6.5' Bed) & Dually (8' Bed)(Excl. 2007 Classic)	Yes	Yes	21-534590	21-534595
2007	2019	Chevrolet	Silverado 2500/3500HD Ext Cab (8' Bed)(Excl. 2007 Classic)(Excl. Dually)	Yes	Yes	21-534600	21-534605
2019	2019	Chevrolet	Silverado LD Double Cab (6.5' Bed)	Yes	Yes	21-534590	21-534595
2009	2018	Dodge	Ram 1500 Crew Cab (6.5' Bed)	No	No	21-534310	21-534315
2009	2018	Dodge	Ram 1500 Crew Cab (6.5' Bed) ¹	Yes	No	21-534320	21-534325
2009	2018	Dodge	Ram 1500 Quad Cab (6.5' Bed)	No	No	21-534310	21-534315
2010	2020	Dodge	Ram 2500/3500 Crew Cab (6.5' Bed) ¹	Yes	No	21-534320	21-534325

CONTINUED ON NEXT PAGE

PRO TRAXX 5 OVAL WHEEL-TO-WHEEL NERF STEP BARS CONTINUED

304 STAINLESS STEEL / BLACK POWDER COAT

START	END	MAKE	MODEL	BRACKET CVR	ISOLATOR INCLUDED	POLISHED	BLACK
2010	2018	Dodge	Ram 2500/3500 Crew Cab (8' Bed)(Excl. Dually) 1,2	Yes	Yes	21-934330	21-934335
2009	2014	Ford	F-150 SuperCab (6.5' Bed)	Yes	No	21-934610	—
2015	2020	Ford	F-150 SuperCab (6.5' Bed)	Yes	Yes	21-934610	21-934615
2015	2020	Ford	F-150 SuperCrew (6.5' Bed)	Yes	Yes	21-934630	21-934635
2017	2023	Ford	F-250/350 Crew Cab (6.75' Bed)	Yes	No	—	21-934645
2017	2022	Ford	F-250/350 Crew Cab (8' Bed)	Yes	Yes	—	21-934655
2017	2023	Ford	F-250/350 SuperCab (6.75' Bed)	Yes	No	—	21-934665
2017	2022	Ford	F-250/350 SuperCab (8' Bed)	Yes	Yes	—	21-934675
1999	2016	Ford	F-250/350/450/550 Crew Cab (6.75' Bed)	Yes	No	—	21-934015
1999	2016	Ford	F-250/350/450/550 Crew Cab (8' Bed)(Excl. Dually)	Yes	Yes	21-934220	21-934235
1999	2016	Ford	F-250/350/450/550 SuperCab (6.75' Bed)	Yes	No	21-934250	21-934255
1999	2016	Ford	F-250/350/450/550 SuperCab (8' Bed)(Excl. Dually)	Yes	Yes	—	21-934515
2007	2018	GMC	Sierra 1500 Crew Cab (6.5' Bed)(Excl. 2007 Classic)	Yes	No	21-934590	21-934595
2019	2023	GMC	Sierra 1500 Crew Cab (6.5' Bed)(Excl. 2019 Limited)	Yes	No	21-934600	21-934605
2007	2018	GMC	Sierra 1500 Crew Cab (6.5' Bed)	Yes	Yes	21-934570	21-934575
2019	2023	GMC	Sierra 1500 Crew Cab (6.5' Bed)(Excl. 2019 Limited)	Yes	Yes	21-934690	21-934695
2007	2018	GMC	Sierra 1500 Double Cab (6.5' Bed)	Yes	Yes	21-934590	21-934595
2019	2023	GMC	Sierra 1500 Double Cab (6.5' Bed)(Excl. 2019 Limited)	Yes	Yes	21-934710	21-934715
2007	2018	GMC	Sierra 1500 Ext Cab (6.5' Bed)(Excl. 2007 Classic)	Yes	Yes	21-934590	21-934595
2007	2018	GMC	Sierra 1500 Ext Cab (8' Bed)(Excl. 2007 Classic)(Excl. Dually)	Yes	Yes	21-934690	21-934695
2019	2019	GMC	Sierra 1500 Limited Double Cab (6.5' Bed)	Yes	Yes	21-934590	21-934595
2020	2023	GMC	Sierra 2500/3500 Crew Cab (6.5' Bed)	Yes	Yes	21-934760	21-934765
2020	2023	GMC	Sierra 2500/3500 Crew Cab (8' Bed)	Yes	Yes	21-934770	21-934775
2020	2023	GMC	Sierra 2500/3500 Double Cab (8' Bed)	Yes	Yes	21-934750	21-934755
2007	2019	GMC	Sierra 2500/3500HD Crew Cab (6.5' Bed) & Dually (8' Bed)(Excl. 2007 Classic)	Yes	Yes	21-934570	21-934575
2007	2019	GMC	Sierra 2500/3500HD Crew Cab (8' Bed)(Excl. 2007 Classic)(Excl. Dually)	Yes	Yes	21-934590	21-934595
2007	2019	GMC	Sierra 2500/3500HD Double Cab (6.5' Bed) & Dually (8' Bed)	Yes	Yes	21-934590	21-934595
2007	2019	GMC	Sierra 2500/3500HD Double Cab (8' Bed)(Excl. Dually)	Yes	Yes	21-934600	21-934605
2007	2019	GMC	Sierra 2500/3500HD Ext Cab (6.5' Bed) & Dually (8' Bed)(Excl. 2007 Classic)	Yes	Yes	21-934590	21-934595
2007	2019	GMC	Sierra 2500/3500HD Ext Cab (8' Bed)(Excl. 2007 Classic)(Excl. Dually)	Yes	Yes	21-934600	21-934605
2019	2023	Ram	1500 Classic Crew Cab (6.5' Bed)	No	No	21-934310	21-934315
2019	2023	Ram	1500 Classic Crew Cab (6.5' Bed) 1	Yes	No	21-934320	21-934325
2019	2023	Ram	1500 Classic Quad Cab (6.5' Bed)	No	No	21-934310	21-934315
2009	2018	Ram	1500 Crew Cab (6.5' Bed)	No	No	21-934310	21-934315
2019	2023	Ram	1500 Crew Cab (6.5' Bed)(Excl. Classic)	Yes	Yes	21-934700	21-934705
2009	2018	Ram	1500 Crew Cab (8.5' Bed) 1	Yes	No	21-934320	21-934325
2019	2023	Ram	1500 Crew Cab (6.5' Bed)(Excl. Classic)	Yes	Yes	21-934720	21-934725
2009	2018	Ram	1500 Quad Cab (6.5' Bed)	No	No	21-934310	21-934315
2019	2023	Ram	1500 Quad Cab (6.5' Bed)(Excl. Classic)	Yes	Yes	21-934730	21-934735
2010	2020	Ram	2500/3500 Crew Cab (6.5' Bed) 1	Yes	No	21-934320	21-934325
2010	2018	Ram	2500/3500 Crew Cab (8' Bed)(Excl. Dually) 1,2	Yes	Yes	21-934330	21-934335
2019	2023	Ram	2500/3500 Crew Cab (8' Bed)(Excl. Dually) 1	Yes	Yes	21-934340	21-934345
2007	2021	Toyota	Tundra Double Cab (6.5' Bed)	Yes	No	21-934170	21-934175

FOOTNOTES: 1. Requires Minor Drilling. 2. Excludes Chassis Cab With Diesel Exhaust Fluid (DEF) Tank Vehicles.



PRO TRAXX 6 OVAL NERF STEP BARS

304 STAINLESS STEEL / BLACK POWDER COAT

- ▶ Mount kit included
- ▶ 6" oval tube
- ▶ Protects vehicle rocker panels from potential damage
- ▶ Straight tube design
- ▶ Fully welded domed ends
- ▶ Injection molded polymer step pad
- ▶ Injection molded bracket covers included on some applications
- ▶ Bolt-on installation – no drilling required on most applications

FINISH: Polished
MATERIAL: 304 Stainless Steel
WARRANTY: Lifetime

FINISH: Black Powder Coat
MATERIAL: E-Coated Steel
WARRANTY: 3-Year

FULLY WELDED
DOMED ENDS

6" WIDE
OVAL TUBE

POLYMER
STEP PAD



**MOLDED POLYMER STEP PAD
REPLACEMENT P/N#**
 21-50001 (14") 21-50002 (24")

START	END	MAKE	MODEL	BRACKET CVR	MOUNTING	POLISHED	BLACK
2019	2023	Chevrolet	Silverado 1500 Crew Cab (Excl. 2019 LD)	Yes	Rocker Pkt	21-64130	21-64135
2014	2018	Chevrolet	Silverado 1500 Double Cab/Ext Cab (Excl. Classic)(Excl. Diesel)	No	Rocker Pkt	21-63710	—
2020	2023	Chevrolet	Silverado 2500/3500 Crew Cab	Yes	Rocker Pkt	21-64130	21-64135
2019	2019	Chevrolet	Silverado LD Double Cab (Excl. Diesel)	No	Rocker Pkt	21-63710	—
2009	2018	Dodge	Ram 1500 Crew Cab	No	Rocker Pkt	21-63560	21-63565
2010	2023	Dodge	Ram 2500/3500 Crew Cab ¹	No	Rocker Pkt	21-63660	21-63665
2009	2014	Ford	F-150 SuperCab (Excl. Harley Davidson & Raptor)	No	Rocker Pkt	21-63510	—
2015	2023	Ford	F-150 SuperCab	No	Rocker Pkt	21-63930	—
2017	2023	Ford	F-250/350 SuperCab	No	Rocker Pkt	21-63930	—
1999	2016	Ford	F-250/350/450/650 SuperCab	No	Rocker Pkt	21-61210	—
2019	2023	GMC	Sierra 1500 Crew Cab (Excl. 2019 Limited)	Yes	Rocker Pkt	21-64130	21-64135
2014	2018	GMC	Sierra 1500 Double Cab/Ext Cab (Excl. Classic)(Excl. Diesel)	No	Rocker Pkt	21-63710	—
2019	2019	GMC	Sierra 1500 Limited Double Cab (Excl. Classic)(Excl. Diesel)	No	Rocker Pkt	21-63710	—
2020	2023	GMC	Sierra 2500/3500 Crew Cab	Yes	Rocker Pkt	21-64130	21-64135
2015	2019	GMC	Sierra 2500/3500 Double Cab/Ext Cab (Excl. Classic)(Excl. Diesel)	No	Rocker Pkt	21-63710	—
2019	2023	Ram	1500 Classic Crew Cab	No	Rocker Pkt	21-63560	21-63565
2009	2018	Ram	1500 Crew Cab	No	Rocker Pkt	21-63560	21-63565
2019	2023	Ram	1500 Crew Cab (Excl. Classic)	Yes	Rocker Pkt	—	21-64095
2019	2023	Ram	1500 Quad Cab (Excl. Classic)	Yes	Rocker Pkt	21-64090	21-64095
2010	2023	Ram	2500/3500 Crew Cab ¹	No	Rocker Pkt	21-63660	21-63665
2007	2021	Toyota	Tundra CrewMax	No	Rocker Pkt	21-63250	—
2007	2021	Toyota	Tundra Double Cab	No	Rocker Pkt	21-63240	—

FOOTNOTES: 5. Excludes Chassis Cab With Diesel Exhaust Fluid (DEF) Tank Vehicles.

WESTIN[®] NERF STEP BARS

R7 NERF STEP BARS

304 STAINLESS STEEL / BLACK ALUMINUM POWDER COAT

- ▶ Mount kit included
- ▶ 7" wide step area
- ▶ Protects vehicle rocker panels from potential damage
- ▶ Factory style design
- ▶ Injection molded bracket covers included - on some applications
- ▶ Step design conceals brackets for a clean look
- ▶ Includes injection molded bracket covers (most applications)

FINISH: Polished

MATERIAL: 304 Stainless Steel

WARRANTY: Lifetime

FINISH: Black Powder Coat

MATERIAL: Aluminum

WARRANTY: 3-Year



7" WIDE STEP AREA

POLYMER STEP PAD

FACTORY STYLE DESIGN



INCLUDES INJECTION MOLDED BRACKET COVERS



MOLDED POLYMER STEP PAD
REPLACEMENT P/N#
28-70002 (21.5") 28-70002 (22")

START	END	MAKE	MODEL	BRACKET CVR	LENGTH (IN.)	POLISHED	BLACK
2015	2023	Chevrolet	Colorado Crew Cab	Yes	77	28-71010	28-71019
2019	2023	Chevrolet	Silverado 1500 Crew Cab (Excl. 2019 LD)	Yes	87	28-71270	28-71275
2007	2018	Chevrolet	Silverado 1500 Crew Cab (Excl. 2007 Classic)	Yes	87	28-71030	28-71035
2019	2023	Chevrolet	Silverado 1500 Double Cab (Excl. 2019 LD)	Yes	77	28-71260	28-71265
2019	2019	Chevrolet	Silverado LD Double Cab	Yes	77	28-71020	28-71025
2007	2018	Chevrolet	Silverado 1500 Double/Ext Cab (Excl. 2007 Classic)	Yes	77	28-71020	28-71025
2019	2023	Chevrolet	Silverado 1500 Reg Cab	No		28-71250	28-71255
2007	2019	Chevrolet	Silverado 2500/3500HD Crew Cab (Excl. 2007 Classic)	Yes	87	28-71030	28-71035
2020	2023	Chevrolet	Silverado 2500/3500 Crew Cab	Yes	87	28-71270	28-71275
2007	2019	Chevrolet	Silverado 2500/3500HD Double/Ext Cab (Excl. 2007 Classic)	Yes	77	28-71020	28-71025
2020	2023	Chevrolet	Silverado 2500/3500 Double Cab	Yes	77	28-71260	28-71265
2020	2023	Chevrolet	Silverado 2500/3500 Reg Cab	No		28-71250	28-71255
2009	2018	Dodge	Ram 1500 Crew Cab	Yes	85	28-71050	28-71055
2009	2018	Dodge	Ram 1500 Quad Cab	Yes	75	28-71040	28-71045
2010	2023	Dodge	Ram 2500/3500 Crew Cab †	Yes	85	28-71050	28-71055

CONTINUED ON NEXT PAGE

R7 NERF STEP BARS CONTINUED

304 STAINLESS STEEL / BLACK ALUMINUM POWDER COAT

START	END	MAKE	MODEL	BRACKET CVR	LENGTH (IN.)	POLISHED	BLACK
2016	2020	Ford	F-150 SuperCrew	Yes	90	20-71090	20-71096
2009	2014	Ford	F-150 SuperCrew (Excl. Harley Davidson & Raptor)(Excl. 2004 Heritage)	Yes	89	—	20-71075
2016	2020	Ford	F-150 SuperCab	Yes	76	—	20-71065
2017	2020	Ford	F-250/350 Crew Cab	Yes	90	20-71090	20-71096
1999	2016	Ford	F-250/350/450/550 Crew Cab	Yes	90	—	20-71116
2017	2020	Ford	F-250/350 SuperCab	Yes	76	—	20-71065
2019	2020	Ford	Ranger SuperCrew	Yes	—	—	20-71295
2015	2020	GMC	Canyon Crew Cab	Yes	77	20-71010	20-71015
2019	2020	GMC	Sierra 1500 Crew Cab (Excl. 2019 Limited)	Yes	87	20-71270	20-71276
2007	2018	GMC	Sierra 1500 Crew Cab (Excl. 2007 Classic)	Yes	87	20-71030	20-71036
2019	2020	GMC	Sierra 1500 Double Cab (Excl. 2019 Limited)	Yes	—	20-71260	20-71266
2019	2019	GMC	Sierra 1500 Limited Double Cab (Excl. 2007 Classic)	Yes	77	20-71020	20-71026
2007	2018	GMC	Sierra 1500 Double/Ext Cab (Excl. 2007 Classic)	Yes	77	20-71020	20-71026
2019	2020	GMC	Sierra 1500 Reg Cab	No	—	20-71250	20-71256
2007	2019	GMC	Sierra 2500/3500HD Crew Cab (Excl. 2007 Classic)	Yes	87	20-71030	20-71036
2020	2020	GMC	Sierra 2500/3500 Crew Cab	Yes	87	20-71270	20-71276
2007	2019	GMC	Sierra 2500/3500HD Double/Ext Cab (Excl. 2007 Classic)	Yes	77	20-71020	20-71026
2020	2020	GMC	Sierra 2500/3500 Double Cab	Yes	87	20-71260	20-71266
2020	2020	GMC	Sierra 2500/3500 Reg Cab	No	—	20-71250	20-71256
2017	2020	Nissan	Titan Crew Cab	No	—	—	20-71165
2016	2020	Nissan	Titan XD Crew Cab	No	83	—	20-71165
2019	2020	Ram	1500 Crew Cab (Excl. Classic)	Yes	66	20-71220	20-71226
2019	2020	Ram	1500 Classic Crew Cab	Yes	66	20-71080	20-71086
2009	2018	Ram	1500 Crew Cab	Yes	66	20-71080	20-71086
2019	2020	Ram	1500 Quad Cab (Excl. Classic)	Yes	66	20-71030	—
2019	2020	Ram	1500 Classic Quad Cab	Yes	76	20-71040	20-71046
2009	2018	Ram	1500 Quad Cab	Yes	76	20-71040	20-71046
2010	2020	Ram	2500/3500 Crew Cab ¹	Yes	66	20-71060	20-71066
2016	2020	Toyota	Tacoma Access Cab	Yes	68	—	20-71126
2007	2021	Toyota	Tundra CrewMax	Yes	94	—	20-71156

FOOTNOTES: 1. Excludes Chassis Cab With Diesel Exhaust Fluid (DEF) Tank Vehicles.



WESTIN[®] NERF STEP BARS

OUTLAW NERF STEP BAR TEXTURED BLACK

- » 2" diameter wall tubing for maximum durability
- » 16 gauge steel top step surface plate
- » Protects vehicle rocker panels from potential damage
- » Provides 4 3/4" of step area
- » Protects vehicle rocker panels from potential damage
- » Fits tight to rocker panel for a solid fit and rugged look
- » Coarse textured step area for slip resistance
- » Silicon sealed to reduce vibration
- » Welded stamped flange for added structure and strength
- » Unique dimple stamped top plate
- » Custom die-cast riveted logo badge
- » Bolt-on installation - no drilling required
- » Hardware and mounting brackets included
- » E-Coated base coat provides long lasting corrosion protection
- » Available in textured black finish

FINISH: Textured Black Powder Coat
MATERIAL: E-Coated Steel
WARRANTY: 3-Year



START	END	MAKE	MODEL	TEXTURED BLACK
2014	2018	Chevrolet	Silverado 1500 Crew Cab	98-93729
2019	2023	Chevrolet	Silverado 1500 Crew Cab (Excl. 2019 LD)	98-94138
2014	2018	Chevrolet	Silverado 1500 Double Cab	98-93719
2015	2019	Chevrolet	Silverado 2500/3500 Crew Cab	98-93729
2020	2023	Chevrolet	Silverado 2500/3500 Crew Cab	98-94138
2015	2019	Chevrolet	Silverado 2500/3500 Double Cab	98-93719
2015	2019	Chevrolet	Silverado LD Double Cab	98-93719
2009	2018	Dodge	Ram 1500 Crew Cab	98-93569
2010	2023	Dodge	Ram 2500/3500 Crew Cab	98-93669
2014	2018	GMC	Sierra 1500 Crew Cab	98-93729
2015	2023	GMC	Sierra 1500 Crew Cab (Excl. 2019 Limited)	98-94138
2014	2018	GMC	Sierra 1500 Double Cab	98-93719
2015	2019	GMC	Sierra 1500 Limited Double Cab	98-93719
2015	2019	GMC	Sierra 2500/3500 Crew Cab	98-93729
2020	2023	GMC	Sierra 2500/3500 Crew Cab	98-94138
2015	2019	GMC	Sierra 2500/3500 Double Cab	98-93719
2020	2023	Jeep	Gladiator	98-94169
2019	2023	Ram	1500 Classic Crew Cab	98-93669
2009	2018	Ram	1500 Crew Cab	98-93669
2019	2023	Ram	1500 Crew Cab (Excl. Classic)	98-94089
2010	2023	Ram	2500/3500 Crew Cab	98-93669
2014	2023	Toyota	4Runner 40th Anniversary & Premium/TRD Off-Road & Pro Trail Venture (Excl. Limited/Nightshade/TRD Sport)	98-93839
2010	2017	Toyota	4Runner Trail (Excl. Limited)	98-93839
2005	2023	Toyota	Tacoma Double Cab	98-92779
2010	2017	Toyota	4Runner Trail (Excl. Limited)	98-93839
2005	2023	Toyota	Tacoma Double Cab	98-92779
2010	2017	Toyota	4Runner Trail (Excl. Limited)	98-93839
2005	2023	Toyota	Tacoma Double Cab	98-92779

PLATINUM 4 OVAL NERF STEP BARS

304 STAINLESS STEEL / BLACK POWDER COAT

- ▶ Mount kit included
- ▶ 4" oval tube
- ▶ Protects vehicle rocker panels from potential damage

FINISH: Polished
MATERIAL: 304 Stainless Steel
WARRANTY: Lifetime

FINISH: Black Powder Coat
MATERIAL: E-Coated Steel
WARRANTY: 3-Year

- ▶ 90° mandrel bends*
- ▶ Injection molded polymer step pad
- ▶ Recessed step area
- ▶ Bolt-on installation – no drilling required on

most applications

*Some applications may feature ends with 30° bends

POLYMER STEP PAD

4" WIDE OVAL TUBE

90° FACTORY STYLE BENDS*

90° FRONT

30° FRONT

90° FRONT

90° REAR

30° REAR

30° REAR

90°/90° BEND STYLE

30°/30° BEND STYLE

90°/30° BEND STYLE



MOLDED POLYMER STEP PAD
REPLACEMENT PN# 22-0002 (24")

START	END	MAKE	MODEL	MOUNTING	BEND STYLES	POLISHED	BLACK
2000	2013	Chevrolet	Avalanche 1500 (w/o Cladding)	Body Mnt	90°	—	21-2996
2016	2023	Chevrolet	Colorado Crew Cab	Rocker Pnl	90°	—	21-4016
2015	2022	Chevrolet	Colorado Ext Cab	Rocker Pnl	90°	—	21-4005
1999	2013	Chevrolet	Silverado 1500 Crew Cab	Body Mnt	90°	21-1950	21-1955
2014	2018	Chevrolet	Silverado 1500 Crew Cab	Body Mnt	90°	—	21-3026
2019	2023	Chevrolet	Silverado 1500 Crew Cab (Excl. 2019 LD)	Body Mnt	90°	21-4120	21-4126
2014	2018	Chevrolet	Silverado 1500 Double Cab	Body Mnt	90°	21-3810	21-3816
2019	2023	Chevrolet	Silverado 1500 Double Cab (Excl. 2019 LD)	Body Mnt	90°	21-4120	21-4126
1999	2013	Chevrolet	Silverado 1500 Ext Cab (Excl. 85)	Body Mnt	90°	21-1680	21-1686
1999	2013	Chevrolet	Silverado 1500 Reg Cab (Excl. 85)	Body Mnt	90°	21-1400	21-1406
2001	2007	Chevrolet	Silverado 1500HD Crew Cab	Body Mnt	90°	21-1950	21-1956
2015	2019	Chevrolet	Silverado 2500/3500 Crew Cab	Body Mnt	90°	21-3360	21-3366
2015	2019	Chevrolet	Silverado 2500/3500 Double Cab	Body Mnt	90°	21-3350	21-3356
2001	2014	Chevrolet	Silverado 2500/3500HD Crew Cab (Excl. Canadian Diesel)	Body Mnt	90°	21-1960	21-1966
2001	2014	Chevrolet	Silverado 2500/3500HD Ext Cab	Body Mnt	90°	21-1690	21-1696
2001	2014	Chevrolet	Silverado 2500/3500HD Reg Cab	Body Mnt	90°	21-1400	21-1406
2015	2019	Chevrolet	Silverado 2500/3500HD Reg Cab	Body Mnt	90°	—	21-3344
1999	2004	Chevrolet	Silverado 2500LD Ext Cab	Body Mnt	90°	21-1680	21-1686
1999	2004	Chevrolet	Silverado 2500LD Reg Cab	Body Mnt	90°	21-1400	21-1406
2015	2019	Chevrolet	Silverado LD Double Cab	Body Mnt	90°	21-3810	21-3816
2000	2014	Chevrolet	Suburban 1500 (Excl. 2004-2006 27")	Body Mnt	90°	—	21-2996
2000	2014	Chevrolet	Tahoe (Excl. 2002-2008 27")	Body Mnt	90°	—	21-3005
2011	2017	Dodge	Durango 4x4	Rocker Pnl	90°	—	21-3625
2009	2018	Dodge	Ram 1500 Crew Cab	Rocker Pnl	90°	21-3560	21-3566
2009	2018	Dodge	Ram 1500 Quad Cab	Rocker Pnl	90°	21-3550	21-3556
2002	2008	Dodge	Ram 1500 Quad Cab (Excl. Daytona, Rumble Bee, & SRT-10)	Body Mnt	90°	21-2310	21-2316

CONTINUED ON NEXT PAGE →

PLATINUM 4 OVAL NERF STEP BARS CONTINUED

304 STAINLESS STEEL / BLACK POWDER COAT

START	END	MAKE	MODEL	MOUNTING	BEND STYLES	POLISHED	BLACK
2002	2008	Dodge	Ram 1500 Reg Cab (Excl. Daytona, Rumble Bee, & SRT-10)	Body Mnt	90°	—	21-2325
2009	2018	Dodge	Ram 1500 Reg Cab	Rocker Pnt	90°	21-3540	21-3548
2009	2009	Dodge	Ram 1500/2500/3500 Mega Cab ¹	Body Mnt	90°	—	21-2905
2010	2023	Dodge	Ram 2500/3500 Crew Cab ¹	Rocker Pnt	90°	21-3560	21-3565
2010	2023	Dodge	Ram 2500/3500 Mega Cab ¹	Rocker Pnt	90°	—	21-3675
2008	2009	Dodge	Ram 2500/3500 Quad Cab (Excl. Daytona, Rumble Bee, & SRT-10) ¹	Body Mnt	90°	21-2310	21-2315
2008	2009	Dodge	Ram 2500/3500 Reg Cab (Excl. Daytona, Rumble Bee, & SRT-10) ¹	Body Mnt	90°	—	21-2325
2010	2023	Dodge	Ram 2500/3500 Reg Cab (Excl. Daytona, Rumble Bee, & SRT-10) ¹	Rocker Pnt	90°	21-3540	21-3545
2008	2009	Dodge	Ram 4500/5500 Quad Cab ¹	Body Mnt	90°	21-2310	21-2315
2008	2009	Dodge	Ram 4500/5500 Reg Cab (Excl. Daytona, Rumble Bee, & SRT-10) ¹	Body Mnt	90°	—	21-2325
2011	2019	Ford	Explorer ¹	Rocker Pnt	90°	—	21-3605
2005	2023	Ford	F-150 Reg Cab	Rocker Pnt	90°	21-3920	21-3925
2004	2008	Ford	F-150 Reg Cab (Excl. 2004 Heritage)	Rocker Pnt	90°	—	21-2345
2009	2014	Ford	F-150 SuperCab	Rocker Pnt	90°	—	21-3815
2015	2023	Ford	F-150 SuperCab	Rocker Pnt	90°	—	21-3935
2004	2008	Ford	F-150 SuperCab (Excl. 2004 Heritage)	Rocker Pnt	90°	—	21-2365
2015	2023	Ford	F-150 SuperCrew	Rocker Pnt	90°	21-3940	21-3945
2004	2008	Ford	F-150 SuperCrew (Excl. 2004 Heritage)	Rocker Pnt	90°	—	21-2365
2009	2014	Ford	F-150 SuperCrew ¹	Rocker Pnt	90°	—	21-3325
2007	2023	Ford	F-250/350 Crew Cab	Rocker Pnt	90°	21-3940	21-3945
2017	2023	Ford	F-250/350 Reg Cab	Rocker Pnt	90°	21-3920	21-3925
2007	2023	Ford	F-250/350 SuperCab	Rocker Pnt	90°	—	21-3935
1999	2016	Ford	F-250/350/450/550 Crew Cab	Rocker Pnt	90°	—	21-1235
1999	2016	Ford	F-250/350/450/550 SuperCab	Rocker Pnt	90°	—	21-1215
2015	2023	GMC	Canyon Crew Cab	Rocker Pnt	90°	—	21-4015
2015	2023	GMC	Canyon Ext Cab	Rocker Pnt	90°	—	21-4005
1999	2013	GMC	Sierra 1500 Crew Cab	Body Mnt	90°	21-1950	21-1955
2014	2018	GMC	Sierra 1500 Crew Cab	Body Mnt	90°	—	21-3825
2019	2023	GMC	Sierra 1500 Crew Cab (Excl. 2019 Limited)	Body Mnt	90°	21-4130	21-4135
2014	2018	GMC	Sierra 1500 Double Cab	Body Mnt	90°	21-3810	21-3815
2019	2023	GMC	Sierra 1500 Double Cab (Excl. 2019 Limited)	Body Mnt	90°	21-4120	21-4125
1999	2013	GMC	Sierra 1500 Ext Cab (Excl. SS)	Body Mnt	90°	21-1680	21-1685
2019	2019	GMC	Sierra 1500 Limited Double Cab	Body Mnt	90°	21-3810	21-3815
1999	2013	GMC	Sierra 1500 Reg Cab (Excl. SS)	Body Mnt	90°	21-1400	21-1405
2001	2007	GMC	Sierra 1500HD Crew Cab	Body Mnt	90°	21-1930	21-1935
2005	2019	GMC	Sierra 2500/3500 Crew Cab	Body Mnt	90°	21-3860	21-3865
2015	2019	GMC	Sierra 2500/3500 Double Cab	Body Mnt	90°	21-3950	21-3955
2001	2014	GMC	Sierra 2500/3500HD Crew Cab (Excl. Canadian Diesel)	Body Mnt	90°	21-1950	21-1955
2001	2014	GMC	Sierra 2500/3500HD Ext Cab	Body Mnt	90°	21-1600	21-1605
2001	2014	GMC	Sierra 2500/3500HD Reg Cab (Excl. SS)	Body Mnt	90°	21-1450	21-1455
2015	2019	GMC	Sierra 2500/3500HD Reg Cab	Body Mnt	90°	—	21-3345
1999	2004	GMC	Sierra 2500LD Ext Cab	Body Mnt	90°	21-1630	21-1635
1999	2004	GMC	Sierra 2500LD Reg Cab (Excl. SS)	Body Mnt	90°	21-1450	21-1455
2000	2014	GMC	Yukon 4Dr (Excl. 2004-2010 Z71)	Body Mnt	90°	—	21-3005
2000	2014	GMC	Yukon XL (Excl. 2004-2010 Z71)	Body Mnt	90°	—	21-2995
2000	2023	Jeep	Gladiator	Rocker Pnt	90°	—	21-4165
2011	2017	Jeep	Grand Cherokee ¹	Rocker Pnt	90°	21-3610	21-3615
2007	2018	Jeep	Wrangler JK 2Dr	Rocker Pnt	90°	—	21-3215
2018	2023	Jeep	Wrangler JL Unlimited 4Dr	Rocker Pnt	90°	—	21-4065
2006	2008	Lincoln	Mark LT	Rocker Pnt	90°	—	21-2385
2016	2023	Nissan	Titan XD Crew Cab	Body Mnt	90°	21-4020	21-4025
2019	2023	Ram	1500 Classic Crew Cab	Rocker Pnt	90°	21-3560	21-3565
2019	2023	Ram	1500 Classic Quad Cab	Rocker Pnt	90°	21-3550	21-3555
2019	2023	Ram	1500 Classic Reg Cab	Rocker Pnt	90°	21-3540	21-3545
2009	2016	Ram	1500 Crew Cab	Rocker Pnt	90°	21-3560	21-3565
2019	2023	Ram	1500 Crew Cab (Excl. Classic)	Rocker Pnt	90°	21-4080	21-4085
2009	2018	Ram	1500 Quad Cab	Rocker Pnt	90°	21-3550	21-3555
2019	2023	Ram	1500 Quad Cab (Excl. Classic)	Rocker Pnt	90°	21-4090	21-4095
2009	2018	Ram	1500 Reg Cab	Rocker Pnt	90°	21-3540	21-3545
2010	2023	Ram	2500/3500 Crew Cab ¹	Rocker Pnt	90°	21-3560	21-3565
2010	2023	Ram	2500/3500 Mega Cab ¹	Rocker Pnt	90°	—	21-3375
2010	2023	Ram	2500/3500 Reg Cab (Excl. Daytona, Rumble Bee, & SRT-10) ¹	Rocker Pnt	90°	21-3540	21-3545
2010	2023	Toyota	4Runner Limited/Nightside TRD Sport (Excl. 40th Annu SR5 & Premium TRD Off-Road & Pro Trail Venture)	Rocker Pnt	90°	—	21-3890
2010	2013	Toyota	4Runner SR5 (Excl. Trail)	Rocker Pnt	90°	—	21-3885
2014	2023	Toyota	4Runner 40th Annu SR5 & Premium TRD Off-Road & Pro Trail Venture (Excl. Limited/Nightside/ TRD Sport)	Rocker Pnt	90°	—	21-3835
2010	2017	Toyota	4Runner Trail (Excl. Limited)	Rocker Pnt	90°	—	21-3835
2005	2023	Toyota	Tacoma Double Cab	Rocker Pnt	90°	21-2770	21-2775
2007	2021	Toyota	Tundra CrewMax	Rocker Pnt	90°	—	21-3255
2007	2021	Toyota	Tundra Double Cab	Rocker Pnt	90°/30°	—	21-3245

FOOTNOTES: 3. Requires Minor Drilling. 6. Excludes Chassis Cab With Diesel Exhaust Fluid (DEF) Tank Vehicles. 7. Not Compatible With OEM Skirt Cladding.

NERF STEP BARS

WESTIN®

PLATINUM 4 OVAL WHEEL-TO-WHEEL NERF STEP BARS

304 STAINLESS STEEL / BLACK POWDER COAT

- ▶ Mount kit included
- ▶ Wheel-To-Wheel (W2W) length step bars
- ▶ Protects vehicle rocker panels from potential damage
- ▶ Third step for easy truck bed access
- ▶ 4" oval tube
- ▶ Front mount features a 90° bend
- ▶ 30" bend at far end
- ▶ Isolator bracket included - some application
- ▶ Bolt-on installation - no drilling required on most applications

*Some applications may feature ends with 30° bends

FINISH: Polished
MATERIAL: 304 Stainless Steel
WARRANTY: Lifetime

FINISH: Black Powder Coat
MATERIAL: E-Coated Steel
WARRANTY: 3-Year

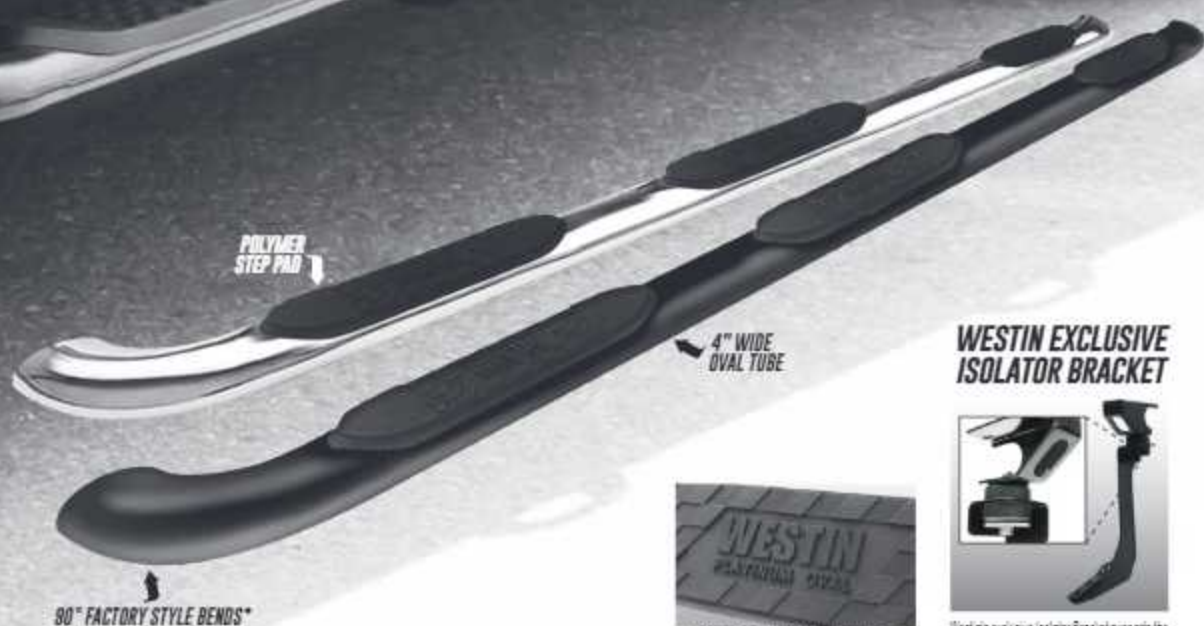

POLYMER STEP PAD

4" WIDE OVAL TUBE

90° FACTORY STYLE BENDS*

WESTIN EXCLUSIVE ISOLATOR BRACKET



MOLDED POLYMER STEP PAD
 24-50014 (14") 24-50020 (20")
 24-50024 (24")

Westin's exclusive Isolator Bracket supports the step bar post the truck cab, which competitors do not offer. Our unique design provides extra bed support without annoying creaking sounds.

START	END	MAKE	MODEL	ISOLATOR INCLUDED	MOUNTING	POLISHED	BLACK
2014	2018	Chevrolet	Silverado 1500 Crew Cab (6.5' Bed)	No	Body Mnt	24-54550	—
2014	2018	Chevrolet	Silverado 1500 Double Cab (6.5' Bed)	No	Body Mnt	—	24-54545
2015	2019	Chevrolet	Silverado 2500/3500HD Crew Cab (8' Bed)(Excl. Dually)	Yes	Body Mnt	24-54590	—
2015	2019	Chevrolet	Silverado 2500/3500HD Double Cab (6.5' Bed) & Dually (8' Bed)	No	Body Mnt	24-54560	24-54565
2019	2019	Chevrolet	Silverado LD Double Cab (6.5' Bed)	No	Body Mnt	—	24-54545
2015	2020	Ford	F-150 SuperCab (6.5' Bed)	Yes	Rocker Pnt	24-54610	—
1999	2016	Ford	F-250/350/450/550 Crew Cab (8' Bed)(Excl. Dually)	No	Rocker Pnt	—	24-54035
2014	2018	GMC	Sierra 1500 Crew Cab (6.5' Bed)	No	Body Mnt	24-54560	—
2014	2018	GMC	Sierra 1500 Double Cab (6.5' Bed)	No	Body Mnt	—	24-54545
2019	2019	GMC	Sierra 1500 Limited Double Cab (6.5' Bed)	No	Body Mnt	—	24-54545
2015	2019	GMC	Sierra 2500/3500HD Crew Cab (8' Bed)(Excl. Dually)	Yes	Body Mnt	24-54590	—
2015	2019	GMC	Sierra 2500/3500HD Double Cab (6.5' Bed) & Dually (8' Bed)	No	Body Mnt	24-54560	24-54565
2007	2021	Toyota	Tundra Double Cab (6.5' Bed)	No	Rocker Pnt	—	24-54175

FOOTNOTES: 1. Requires Minor Drilling. 7. Excludes Chassis Cab With Diesel Exhaust Fluid (DEF) Tank Vehicles.

WESTIN

NERF STEP BARS

PREMIER 4 OVAL NERF STEP BARS

304 STAINLESS STEEL / BLACK POWDER COAT

- » Vehicle specific mounting kit required - sold separately
- » 4" oval tube
- » Protects vehicle rocker panels from potential damage
- » Cradle mounted tubes
- » Injection molded polymer step pad
- » Molded oval end caps
- » Bolt-on installation - no drilling required on most applications

FINISH: Polished
 MATERIAL: 304 Stainless Steel
 WARRANTY: Lifetime

FINISH: Black Powder Coat
 MATERIAL: E-Coated Steel
 WARRANTY: 3-Year



MOLDED OVAL END CAPS

4" WIDE OVAL TUBE

POLYMER STEP PAD



MOLDED POLYMER STEP PAD
22-5001 (26") 22-5002 (28")

START	END	MAKE	MODEL	MOUNTING	LENGTH (IN.)	POLISHED	BLACK	REQUIRED MOUNT KIT
2008	2017	Buick	Enclave	Rocker Pnl	75"	22-5020	22-5025	22-1758
2002	2005	Chevrolet	Riviera (w/ Cladding)	Rocker Pnl	91"	22-5040	22-5045	22-1535
2003	2013	Chevrolet	Avalanche (w/O Cladding)	Rocker Pnl	91"	22-5040	22-5045	22-1535
1988	2000	Chevrolet	C/K 1500/2500/3500 Ext Cab (Excl. 1999-2000 Silverado 1500/2500)	Body Mnt	75"	22-5020	22-5025	22-1129
2004	2012	Chevrolet	Colorado Crew Cab	Body Mnt	75"	22-5020	22-5025	22-1399
2015	2022	Chevrolet	Colorado Crew Cab	Rocker Pnl	75"	22-5020	22-5025	22-2075
2005	2009	Chevrolet	Equinox	Rocker Pnl	75"	22-5020	22-5025	22-1775
2004	2013	Chevrolet	Silverado 1500 Crew Cab (Excl. Canadian Diesel)	Body Mnt	91"	22-5040	22-5045	22-1075
2014	2018	Chevrolet	Silverado 1500 Crew Cab	Rocker Pnl	85"	22-5030	22-5035	22-2015
2019	2023	Chevrolet	Silverado 1500 Crew Cab	Rocker Pnl	85"	22-5030	22-5035	22-2255
2014	2018	Chevrolet	Silverado 1500 Double Cab	Rocker Pnl	75"	22-5020	22-5025	22-2015
2019	2023	Chevrolet	Silverado 1500 Double Cab (Excl. 2019 LD)	Rocker Pnl	85"	22-5030	22-5035	22-2255
1999	2013	Chevrolet	Silverado 1500 Reg Cab	Body Mnt	59"	22-5000	22-5005	22-1085
2014	2018	Chevrolet	Silverado 1500 Reg Cab	Rocker Pnl	59"	22-5000	22-5005	22-2005
1999	2013	Chevrolet	Silverado 1500 2500 LD Ext Cab (Excl. Canadian Diesel)	Body Mnt	75"	22-5020	22-5025	22-1085
2020	2023	Chevrolet	Silverado 2500/3500 Crew Cab	Rocker Pnl	85"	22-5030	22-5035	22-2255
2015	2019	Chevrolet	Silverado 2500/3500 Double Cab	Rocker Pnl	75"	22-5020	22-5025	22-2015
2020	2023	Chevrolet	Silverado 2500/3500 Double Cab	Rocker Pnl	85"	22-5030	22-5035	22-2255
2015	2019	Chevrolet	Silverado 2500/3500 Reg Cab	Rocker Pnl	59"	22-5000	22-5005	22-2005
2001	2014	Chevrolet	Silverado 2500/3500HD Crew Cab (Excl. Canadian Diesel)	Body Mnt	91"	22-5040	22-5045	22-1075
2015	2019	Chevrolet	Silverado 2500/3500HD Crew Cab	Rocker Pnl	85"	22-5030	22-5035	22-2015
1999	2014	Chevrolet	Silverado 2500/3500HD Ext Cab (Excl. Canadian Diesel)	Body Mnt	75"	22-5020	22-5025	22-1085
1999	2014	Chevrolet	Silverado 2500/3500HD Reg Cab (Excl. Canadian Diesel)	Body Mnt	59"	22-5000	22-5005	22-1085
2019	2019	Chevrolet	Silverado LD Double Cab	Rocker Pnl	75"	22-5020	22-5025	22-2015
2005	2014	Chevrolet	Suburban (Excl. Hybrid & Z71)	Rocker Pnl	91"	22-5040	22-5045	22-1535
2000	2014	Chevrolet	Tahoe 4Dr (Excl. 2002-2004 Z71)	Body Mnt	75"	22-5020	22-5025	22-1135

CONTINUED ON NEXT PAGE

PREMIER 4 OVAL NERF STEP BARS CONTINUED

304 STAINLESS STEEL / BLACK POWDER COAT

START	END	MAKE	MODEL	MOUNTING	LENGTH (IN.)	POLISHED	BLACK	REQUIRED MOUNT KIT
2005	2014	Chevrolet	Tahoe 4Dr (Excl. Hybrid & Z71)	Rocker Pnt	75"	22-5020	22-5025	22-1530
2009	2017	Chrysler	Traverse	Rocker Pnt	79"	22-5020	22-5025	22-1795
2006	2009	Chrysler	Aspen	Rocker Pnt	75"	22-5020	22-5025	22-1405
2004	2010	Dodge	Durango	Rocker Pnt	75"	22-5020	22-5025	22-1405
2011	2017	Dodge	Durango	Rocker Pnt	75"	22-5020	22-5025	22-1985
2009	2018	Dodge	Ram 1500 Crew Cab	Rocker Pnt	89"	22-5000	22-5005	22-1905
1990	2001	Dodge	Ram 1500 Quad Cab	Body Mnt	75"	22-5020	22-5025	22-1005
2002	2008	Dodge	Ram 1500 Quad Cab (Excl. Daytona, Rumble Bee, & SRT-10)	Body Mnt	85"	22-5030	22-5035	22-1015
2009	2018	Dodge	Ram 1500 Quad Cab	Rocker Pnt	75"	22-5020	22-5025	22-1905
2002	2008	Dodge	Ram 1500 Reg Cab (Excl. Daytona, Rumble Bee, & SRT-10)	Body Mnt	59"	22-5000	22-5005	22-1025
2009	2018	Dodge	Ram 1500 Reg Cab	Rocker Pnt	59"	22-5000	22-5005	22-1895
2010	2023	Dodge	Ram 2500/3500 Crew Cab 13	Rocker Pnt	85"	22-5030	22-5035	22-1905
1998	2002	Dodge	Ram 2500/3500 Quad Cab	Body Mnt	75"	22-5020	22-5025	22-1005
2000	2009	Dodge	Ram 2500/3500 Quad Cab (Excl. Daytona, Rumble Bee, & SRT-10)	Body Mnt	89"	22-5030	22-5035	22-1015
2009	2009	Dodge	Ram 2500/3500 Reg Cab (Excl. Daytona, Rumble Bee, & SRT-10)	Body Mnt	59"	22-5000	22-5005	22-1025
2010	2023	Dodge	Ram 2500/3500 Reg Cab (Excl. Daytona, Rumble Bee, & SRT-10) ¹	Rocker Pnt	59"	22-5000	22-5005	22-1895
2009	2009	Dodge	Ram 4500/5500 Quad Cab (Excl. Daytona, Rumble Bee, & SRT-10)	Body Mnt	89"	22-5030	22-5035	22-1015
2008	2009	Dodge	Ram 4500/5500 Reg Cab (Excl. Daytona, Rumble Bee, & SRT-10)	Body Mnt	59"	22-5000	22-5005	22-1025
2009	2012	Ford	Escape	Rocker Pnt	61.5"	22-5060	22-5065	22-1705
1997	2014	Ford	Expedition ¹	Rocker Pnt	75"	22-5020	22-5025	22-1105
2007	2014	Ford	Expedition EL ¹	Rocker Pnt	91"	22-5040	22-5045	22-1105
2002	2008	Ford	Explorer 4Dr	Rocker Pnt	75"	22-5020	22-5025	22-1165
2009	2010	Ford	Explorer 4Dr ¹	Frame	75"	22-5020	22-5025	22-1575
2011	2019	Ford	Explorer 4Dr ¹	Rocker Pnt	75"	22-5020	22-5025	22-1975
2007	2010	Ford	Explorer Sport Trac	Frame	89"	22-5030	22-5035	22-1575
2004	2014	Ford	F-150 Reg Cab (Excl. 2004 Heritage)	Rocker Pnt	59"	22-5000	22-5005	22-1885
2015	2023	Ford	F-150 Reg Cab	Rocker Pnt	59"	22-5000	22-5005	22-2055
2004	2014	Ford	F-150 SuperCab (Excl. 2004 Heritage) ¹	Rocker Pnt	89"	22-5030	22-5035	22-1885
2015	2023	Ford	F-150 SuperCab	Rocker Pnt	75"	22-5020	22-5025	22-2055
2001	2004	Ford	F-150 SuperCrew (2004 Heritage Only)	Rocker Pnt	85"	22-5030	22-5035	22-1885
2004	2008	Ford	F-150 SuperCrew (Excl. 2004 Heritage)	Rocker Pnt	85"	22-5030	22-5035	22-1885
2009	2014	Ford	F-150 SuperCrew	Rocker Pnt	91"	22-5040	22-5045	22-1885
2015	2023	Ford	F-150 SuperCrew	Rocker Pnt	91"	22-5040	22-5045	22-2055
1997	2004	Ford	F-150 250LD Reg Cab (2004 Heritage Only)	Rocker Pnt	59"	22-5000	22-5005	22-1885
1997	2004	Ford	F-150 250LD SuperCab (2004 Heritage Only)	Rocker Pnt	75"	22-5020	22-5025	22-1885
2007	2022	Ford	F-250/350 Crew Cab	Rocker Pnt	91"	22-5040	22-5045	22-2055
2017	2022	Ford	F-250/350 Reg Cab	Rocker Pnt	59"	22-5000	22-5005	22-2055
2017	2022	Ford	F-250/350 SuperCab	Rocker Pnt	75"	22-5020	22-5025	22-2055
1999	2016	Ford	F-250/350 450/550 Crew Cab	Rocker Pnt	91"	22-5040	22-5045	22-1835
1999	2016	Ford	F-250/350 450/550 Reg Cab	Rocker Pnt	59"	22-5000	22-5005	22-1835
1999	2016	Ford	F-250/350 450/550 SuperCab	Rocker Pnt	75"	22-5020	22-5025	22-1835
1998	2012	Ford	Ranger Ext Cab 2Dr	Rocker Pnt	61.5"	22-5060	22-5065	22-1445
1998	2012	Ford	Ranger Ext Cab 4Dr	Rocker Pnt	72"	22-5050	22-5055	22-1455
2019	2022	Ford	Ranger SuperCab	Rocker Pnt	72"	22-5050	22-5055	22-2285
2019	2022	Ford	Ranger SuperCrew	Rocker Pnt	78"	22-5020	22-5025	22-2285
2007	2016	GMC	Acadia (Excl. Denali)	Rocker Pnt	75"	22-5020	22-5025	22-1795
1988	2000	GMC	C/K 1500/2500/3500 (Excl. 1999-2000 Sierra 1500/2500)	Body Mnt	75"	22-5020	22-5025	22-1125
2004	2012	GMC	Canyon Crew Cab	Body Mnt	75"	22-5020	22-5025	22-1095
2015	2022	GMC	Canyon Crew Cab	Rocker Pnt	75"	22-5020	22-5025	22-2075
2004	2015	GMC	Sierra 1500 Crew Cab (Excl. Canadian Diesel)	Body Mnt	91"	22-5040	22-5045	22-1075
2014	2018	GMC	Sierra 1500 Crew Cab	Rocker Pnt	85"	22-5030	22-5035	22-2015
2019	2023	GMC	Sierra 1500 Crew Cab	Rocker Pnt	89"	22-5030	22-5035	22-2285
2014	2018	GMC	Sierra 1500 Double Cab	Rocker Pnt	75"	22-5020	22-5025	22-2015
2019	2023	GMC	Sierra 1500 Double Cab (Excl. 2019 Limited)	Rocker Pnt	85"	22-5030	22-5035	22-2285
2019	2019	GMC	Sierra 1500 Limited Double Cab	Rocker Pnt	75"	22-5020	22-5025	22-2015
1998	2019	GMC	Sierra 1500 Reg Cab	Body Mnt	59"	22-5000	22-5005	22-1085
2014	2018	GMC	Sierra 1500 Reg Cab	Rocker Pnt	59"	22-5000	22-5005	22-2005
1998	2013	GMC	Sierra 1500 2500LD Ext Cab (Excl. Canadian Diesel)	Body Mnt	75"	22-5020	22-5025	22-1095
2020	2023	GMC	Sierra 2500/3500 Crew Cab	Rocker Pnt	85"	22-5030	22-5035	22-2295
2015	2019	GMC	Sierra 2500/3500 Double Cab	Rocker Pnt	75"	22-5020	22-5025	22-2015
2020	2023	GMC	Sierra 2500/3500 Double Cab	Rocker Pnt	85"	22-5030	22-5035	22-2295
2015	2019	GMC	Sierra 2500/3500 Reg Cab	Rocker Pnt	59"	22-5000	22-5005	22-2005
2001	2014	GMC	Sierra 2500/3500HD Crew Cab (Excl. Canadian Diesel)	Body Mnt	91"	22-5040	22-5045	22-1075
2015	2019	GMC	Sierra 2500/3500HD Crew Cab	Rocker Pnt	89"	22-5030	22-5035	22-2015
1999	2014	GMC	Sierra 2500/3500HD Ext Cab (Excl. Canadian Diesel)	Body Mnt	75"	22-5020	22-5025	22-1065
1999	2014	GMC	Sierra 2500/3500HD Reg Cab (Excl. Canadian Diesel)	Body Mnt	59"	22-5000	22-5005	22-1065
2000	2004	GMC	Yukon 4Dr (Excl. 2004 Z71)	Body Mnt	75"	22-5020	22-5025	22-1135
2005	2014	GMC	Yukon 4Dr (Excl. Hybrid & Z71)	Rocker Pnt	75"	22-5020	22-5025	22-1535
2005	2014	GMC	Yukon XL (Excl. Hybrid & Z71)	Rocker Pnt	91"	22-5040	22-5045	22-1535
2006	2014	Honda	Ridgeline	Rocker Pnt	85"	22-5020	22-5025	22-1675
2006	2010	Hummer	H3	Frame	72"	22-5050	22-5055	22-1635
2004	2010	Infiniti	QX56	Rocker Pnt	78"	22-5020	22-5025	22-1415
2006	2008	Isuzu	i-Series Crew Cab	Body Mnt	75"	22-5020	22-5025	22-1395
2006	2010	Jeep	Commander	Rocker Pnt	72"	22-5050	22-5055	22-1545
2005	2010	Jeep	Grand Cherokee	Rocker Pnt	72"	22-5050	22-5055	22-1545
2011	2017	Jeep	Grand Cherokee ¹	Rocker Pnt	72"	22-5050	22-5055	22-1985
2007	2018	Jeep	Wrangler JK 2Dr	Frame	59"	22-5000	22-5005	22-1725
2007	2018	Jeep	Wrangler JK Unlimited 4Dr	Frame	72"	22-5050	22-5055	22-1725
2006	2008	Lincoln	Mark LT	Rocker Pnt	85"	22-5030	22-5035	22-1885
2008	2012	Mazda	Tribute	Rocker Pnt	61.5"	22-5060	22-5065	22-1785
2003	2010	Mercury	Manner	Rocker Pnt	61.5"	22-5060	22-5065	22-1785
2008	2010	Mercury	Mountaineer ¹	Frame	75"	22-5020	22-5025	22-1875

CONTINUED ON NEXT PAGE →

WESTIN

NERF STEP BARS

PREMIER 4 OVAL NERF STEP BARS CONTINUED 304 STAINLESS STEEL / BLACK POWDER COAT

START	END	MAKE	MODEL	MOUNTING	LENGTH (IN.)	POLISHED	BLACK	REQUIRED MOUNT KIT
2004	2015	Nissan	Armada	Rocker Pnl	75"	22-9020	22-9025	22-1415
2005	2021	Nissan	Frontier Crew Cab	Rocker Pnl	75"	22-9020	22-9025	22-1525
2005	2021	Nissan	Frontier Ext Cab	Rocker Pnl	61.9"	22-9060	22-9065	22-1525
2005	2012	Nissan	Patrol	Rocker Pnl	72"	22-9050	22-9055	22-1525
2017	2023	Nissan	Titan	Rocker Pnl	85"	22-9030	22-9035	22-2225
2004	2015	Nissan	Titan Crew Cab	Rocker Pnl	85"	22-9030	22-9035	22-1415
2004	2015	Nissan	Titan Ext King Cab	Rocker Pnl	75"	22-9020	22-9025	22-1415
2016	2020	Nissan	Titan XD Crew Cab	Rocker Pnl	85"	22-9030	22-9035	22-2225
2005	2015	Nissan	Xterra	Rocker Pnl	61.9"	22-9060	22-9065	22-1525
2006	2009	Pontiac	Tonant	Rocker Pnl	75"	22-9020	22-9025	22-1775
2009	2018	Ram	1500 Crew Cab	Rocker Pnl	85"	22-9030	22-9035	22-1905
2019	2023	Ram	1500 Crew Cab (Excl. Classic)	Rocker Pnl	85"	22-9030	22-9035	22-2245
2019	2023	Ram	1500 Crew Cab Classic	Rocker Pnl	85"	22-9030	22-9035	22-1905
2009	2018	Ram	1500 Quad Cab	Rocker Pnl	75"	22-9020	22-9025	22-1905
2019	2023	Ram	1500 Quad Cab (Excl. Classic)	Rocker Pnl	75"	22-9020	22-9025	22-2245
2019	2023	Ram	1500 Quad Cab Classic	Rocker Pnl	75"	22-9020	22-9025	22-1905
2009	2018	Ram	1500 Reg Cab	Rocker Pnl	59"	22-9000	22-9005	22-1895
2019	2023	Ram	1500 Reg Cab Classic	Rocker Pnl	59"	22-9000	22-9005	22-1895
2010	2023	Ram	2500/3500 Crew Cab ¹	Rocker Pnl	85"	22-9030	22-9035	22-1905
2010	2023	Ram	2500/3500 Reg Cab (Excl. Daytona, Rumble Bee, & SRT-10) ²	Rocker Pnl	59"	22-9000	22-9005	22-1895
2007	2009	Saturn	Outlook	Rocker Pnl	75"	22-9020	22-9025	22-1795
2008	2007	Saturn	Vue	Rocker Pnl	75"	22-9020	22-9025	22-1775
2010	2012	Toyota	4-Runner (Excl. Trail)	Rocker Pnl	72"	22-9050	22-9055	22-1945
2010	2018	Toyota	4Runner Limited (Excl. Trail) ³	Rocker Pnl	72"	22-9050	22-9055	22-1945
2010	2013	Toyota	4Runner SR5 (Excl. Trail) ⁴	Rocker Pnl	72"	22-9050	22-9055	22-1945
2009	2014	Toyota	FJ Cruiser	Frame	61.9"	22-9060	22-9065	22-1610
2005	2013	Toyota	Highlander	Rocker Pnl	72"	22-9050	22-9055	22-1825
2005	2023	Toyota	Tacoma Access Cab	Rocker Pnl	72"	22-9050	22-9055	22-1475
2005	2023	Toyota	Tacoma Double Cab	Rocker Pnl	85"	22-9030	22-9035	22-1475
1999	2006	Toyota	Tundra Access Cab 4Dr	Frame	75"	22-9020	22-9025	22-1345
2007	2021	Toyota	Tundra CrewMax	Rocker Pnl	91"	22-9040	22-9045	22-1665
2004	2006	Toyota	Tundra Double Cab	Frame	85"	22-9030	22-9035	22-1345
2007	2021	Toyota	Tundra Double Cab	Rocker Pnl	75"	22-9020	22-9025	22-1665

FOOTNOTES: 1. Requires Minor Drilling For 2008 And Older. 2. Not Compatible On Vehicles With Power Retracting Boards If Equipped. 3. Not Compatible With OEM Skirt Cladding. 4. Requires Minor Trimming Of Driver/Left Side Splash Shield. 5. Excludes Chassis Cab With Diesel Exhaust Fluid (DEF) Tank Vehicles.

PREMIER 6 OVAL NERF STEP BARS

304 STAINLESS STEEL / BLACK POWDER COAT

- ▶ Vehicle specific mounting kit required - sold separately
- ▶ Extra wide 6" oval side step tubes
- ▶ Protects vehicle rocker panels from potential damage
- ▶ Injection molded polymer step pad
- ▶ Molded end caps give the steps a finished factory look
- ▶ Solid construction
- ▶ Bolt-on installation - no drilling required on most applications

FINISH: Polished

MATERIAL: 304 Stainless Steel

WARRANTY: Lifetime

FINISH: Black Powder Coat

MATERIAL: E-Coated Steel

WARRANTY: 3-Year

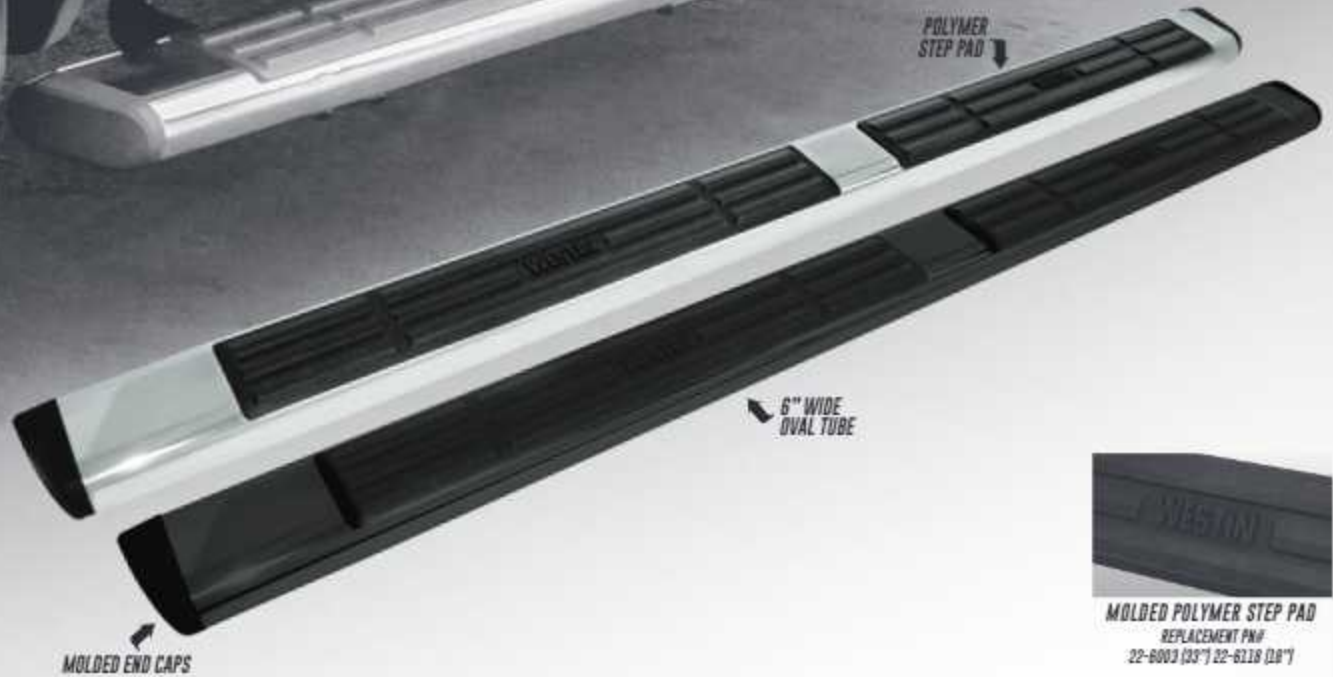

MOLDED POLYMER STEP PAD
REPLACEMENT P/N#
22-6003 (22") 22-6118 (28")

START	END	MAKE	MODEL	MOUNTING	LENGTH (IN.)	POLISHED	BLACK	REQUIRED MOUNT KIT
2008	2017	Buick	Enclave	Rocker Pnl	75"	22-6020	22-6025	22-1795
2002	2006	Chevrolet	Avalanche (w/ Cladding)	Rocker Pnl	91"	22-6040	22-6045	22-1636
2003	2013	Chevrolet	Avalanche (w/o Cladding)	Rocker Pnl	91"	22-6040	22-6045	22-1636
1998	2000	Chevrolet	C/K 1500/2500/3500 Ext Cab (Excl. 1999-2000 Silverado 1500/2500)	Body Mnt	75"	22-6020	22-6025	22-1929
2004	2012	Chevrolet	Colorado Crew Cab	Body Mnt	75"	22-6020	22-6025	22-1396
2015	2022	Chevrolet	Colorado Crew Cab	Rocker Pnl	75"	22-6020	22-6025	22-2078
2005	2009	Chevrolet	Equinox	Rocker Pnl	75"	22-6020	22-6025	22-1775
2004	2015	Chevrolet	Silverado 1500 Crew Cab (Excl. Canadian Diesel)	Body Mnt	91"	22-6040	22-6045	22-1079
2014	2018	Chevrolet	Silverado 1500 Crew Cab	Rocker Pnl	88"	22-6030	22-6035	22-2019
2019	2020	Chevrolet	Silverado 1500 Crew Cab	Rocker Pnl	88"	22-6030	22-6035	22-2258
2014	2018	Chevrolet	Silverado 1500 Double Cab	Rocker Pnl	75"	22-6020	22-6025	22-2015
2019	2020	Chevrolet	Silverado 1500 Double Cab (Excl. 2019 LD)	Rocker Pnl	75"	22-6020	22-6025	22-2258
1999	2013	Chevrolet	Silverado 1500 Reg Cab	Body Mnt	59"	22-6000	22-6005	22-1085
2014	2018	Chevrolet	Silverado 1500 Reg Cab	Rocker Pnl	59"	22-6000	22-6005	22-2005
1999	2013	Chevrolet	Silverado 1500 2500LD Ext Cab (Excl. Canadian Diesel)	Body Mnt	75"	22-6020	22-6025	22-1086
2020	2023	Chevrolet	Silverado 2500/3500 Crew Cab	Rocker Pnl	88"	22-6030	22-6035	22-2258
2020	2023	Chevrolet	Silverado 2500/3500 Double Cab	Rocker Pnl	75"	22-6020	22-6025	22-2258
2001	2014	Chevrolet	Silverado 2500/3500HD Crew Cab (Excl. Canadian Diesel)	Body Mnt	91"	22-6040	22-6045	22-1075
2015	2019	Chevrolet	Silverado 2500/3500HD Crew Cab	Rocker Pnl	89"	22-6030	22-6035	22-2016
2015	2019	Chevrolet	Silverado 2500/3500HD Double Cab	Rocker Pnl	75"	22-6020	22-6025	22-2016
1999	2014	Chevrolet	Silverado 2500/3500HD Ext Cab (Excl. Canadian Diesel)	Body Mnt	75"	22-6020	22-6025	22-1065
1999	2014	Chevrolet	Silverado 2500/3500HD Reg Cab (Excl. Canadian Diesel)	Body Mnt	59"	22-6000	22-6005	22-1065
2015	2019	Chevrolet	Silverado 2500/3500HD Reg Cab	Rocker Pnl	89"	22-6030	22-6035	22-2005
2019	2019	Chevrolet	Silverado LD Double Cab	Rocker Pnl	75"	22-6020	22-6025	22-2016
2005	2014	Chevrolet	Suburban (Excl. Hybrid & Z71)	Rocker Pnl	91"	22-6040	22-6045	22-1535
2000	2014	Chevrolet	Tahoe 40i (Excl. 2002-2004 Z71)	Body Mnt	75"	22-6020	22-6025	22-1133

CONTINUED ON NEXT PAGE →

PREMIER 6 OVAL NERF STEP BARS CONTINUED

304 STAINLESS STEEL / BLACK POWDER COAT

START	END	MAKE	MODEL	MOUNTING	LENGTH (IN.)	POLISHED	BLACK	REQUIRED MOUNT KIT
2006	2014	Chevrolet	Tahoe 4Dr (Excl. Hybrid & Z71)	Rocker Pnl	75"	22-6020	22-6029	22-1536
2009	2017	Chevrolet	Traverse	Rocker Pnl	75"	22-6020	22-6029	22-1794
2006	2009	Chrysler	Aspen	Rocker Pnl	75"	22-6020	22-6029	22-1405
2004	2010	Dodge	Durango	Rocker Pnl	75"	22-6020	22-6029	22-1409
2011	2017	Dodge	Durango	Rocker Pnl	75"	22-6020	22-6029	22-1965
2009	2018	Dodge	Ram 1500 Crew Cab	Rocker Pnl	85"	22-6030	22-6035	22-1905
1998	2001	Dodge	Ram 1500 Quad Cab	Body Mnt	75"	22-6020	22-6029	22-1005
2002	2008	Dodge	Ram 1500 Quad Cab (Excl. Daytona)	Body Mnt	85"	22-6030	22-6035	22-1019
2009	2018	Dodge	Ram 1500 Quad Cab ¹	Rocker Pnl	75"	22-6020	22-6029	22-1909
2002	2008	Dodge	Ram 1500 Reg Cab (Excl. Daytona)	Body Mnt	59"	22-6000	22-6005	22-1029
2009	2018	Dodge	Ram 1500 Reg Cab	Rocker Pnl	59"	22-6000	22-6005	22-1895
2010	2021	Dodge	Ram 2500/3500 Crew Cab ²	Rocker Pnl	85"	22-6030	22-6035	22-1906
1998	2002	Dodge	Ram 2500/3500 Quad Cab	Body Mnt	75"	22-6020	22-6029	22-1009
2003	2009	Dodge	Ram 2500/3500 Quad Cab (Excl. Daytona)	Body Mnt	85"	22-6030	22-6035	22-1015
2003	2009	Dodge	Ram 2500/3500 Reg Cab (Excl. Daytona)	Body Mnt	59"	22-6000	22-6005	22-1023
2010	2021	Dodge	Ram 2500/3500 Reg Cab (Excl. Daytona) ²	Rocker Pnl	85"	22-6030	22-6035	22-1896
2008	2009	Dodge	Ram 4500/5500 Quad Cab (Excl. Daytona)	Body Mnt	85"	22-6030	22-6035	22-1019
2008	2009	Dodge	Ram 4500/5500 Reg Cab (Excl. Daytona)	Body Mnt	59"	22-6000	22-6005	22-1023
1997	2014	Ford	Expedition ¹	Rocker Pnl	75"	22-6020	22-6029	22-1105
2007	2014	Ford	Expedition EL ¹	Rocker Pnl	91"	22-6040	22-6045	22-1105
2002	2009	Ford	Explorer 4Dr	Rocker Pnl	75"	22-6020	22-6029	22-1169
2006	2010	Ford	Explorer 4Dr ¹	Frame	75"	22-6020	22-6029	22-1675
2011	2019	Ford	Explorer 4Dr ¹	Rocker Pnl	75"	22-6020	22-6029	22-1973
2007	2010	Ford	Explorer Sport Trac	Frame	85"	22-6030	22-6035	22-1875
2004	2014	Ford	F-150 Reg Cab (Excl. 2004 Heritage)	Rocker Pnl	59"	22-6000	22-6005	22-1895
2015	2023	Ford	F-150 Reg Cab	Rocker Pnl	59"	22-6000	22-6005	22-2055
2004	2014	Ford	F-150 SuperCab (Excl. 2004 Heritage) ¹	Rocker Pnl	85"	22-6030	22-6035	22-1895
2015	2023	Ford	F-150 SuperCab	Rocker Pnl	75"	22-6020	22-6029	22-2059
2001	2004	Ford	F-150 SuperCrew (2004 Heritage Only) (Excl. New Body Style)	Rocker Pnl	85"	22-6030	22-6035	22-1655
2004	2008	Ford	F-150 SuperCrew (Excl. 2004 Heritage)	Rocker Pnl	85"	22-6030	22-6035	22-1895
2009	2014	Ford	F-150 SuperCrew	Rocker Pnl	91"	22-6040	22-6045	22-1895
2015	2023	Ford	F-150 SuperCrew	Rocker Pnl	91"	22-6040	22-6045	22-2059
1997	2004	Ford	F-150 250LD Reg Cab (2004 Heritage Only)	Rocker Pnl	59"	22-6000	22-6005	22-1849
1997	2004	Ford	F-150 250LD SuperCab (2004 Heritage Only)	Rocker Pnl	75"	22-6020	22-6029	22-1845
2017	2023	Ford	F-250/350 Crew Cab	Rocker Pnl	91"	22-6040	22-6045	22-2055
2017	2023	Ford	F-250/350 Reg Cab	Rocker Pnl	59"	22-6000	22-6005	22-2059
2017	2023	Ford	F-250/350 SuperCab	Rocker Pnl	75"	22-6020	22-6029	22-2055
1999	2016	Ford	F-250/350 480/550 Reg Cab	Rocker Pnl	59"	22-6000	22-6005	22-1925
1999	2016	Ford	F-250/350 450/550 SuperCab	Rocker Pnl	75"	22-6020	22-6029	22-1935
1999	2016	Ford	F-250/350 450/550HD Crew Cab	Rocker Pnl	91"	22-6040	22-6045	22-1939
2019	2023	Ford	Ranger SuperCrew	Rocker Pnl	75"	22-6020	22-6029	22-2265
2007	2016	GMC	Acadia (Excl. Denali)	Rocker Pnl	75"	22-6020	22-6029	22-1799
1998	2000	GMC	CX 1500 2500 3500 Ext Cab (Excl. 1999-2000 Sierra 1500 2500)	Body Mnt	75"	22-6020	22-6029	22-1125
2004	2012	GMC	Canyon Crew Cab	Body Mnt	75"	22-6020	22-6029	22-1299
2015	2022	GMC	Canyon Crew Cab	Rocker Pnl	75"	22-6020	22-6029	22-2075
2004	2013	GMC	Sierra 1500 Crew Cab (Excl. Canadian Diesel)	Body Mnt	91"	22-6040	22-6045	22-1075
2014	2018	GMC	Sierra 1500 Crew Cab	Rocker Pnl	85"	22-6030	22-6035	22-2015
2019	2023	GMC	Sierra 1500 Crew Cab	Rocker Pnl	85"	22-6030	22-6035	22-2269
2014	2018	GMC	Sierra 1500 Double Cab	Rocker Pnl	75"	22-6020	22-6029	22-2015
2019	2023	GMC	Sierra 1500 Double Cab (Excl. 2019 Limited)	Rocker Pnl	85"	22-6030	22-6035	22-2269
2015	2019	GMC	Sierra 1500 Limited Double Cab	Rocker Pnl	75"	22-6020	22-6029	22-2015
1999	2019	GMC	Sierra 1500 Reg Cab	Body Mnt	59"	22-6000	22-6005	22-1085
2014	2018	GMC	Sierra 1500 Reg Cab	Rocker Pnl	59"	22-6000	22-6005	22-2005
1999	2019	GMC	Sierra 1500 2500LD Ext Cab (Excl. Canadian Diesel)	Body Mnt	75"	22-6020	22-6029	22-1095
2020	2023	GMC	Sierra 2500/3500 Crew Cab	Rocker Pnl	85"	22-6030	22-6035	22-2259
2020	2023	GMC	Sierra 2500/3500 Double Cab	Rocker Pnl	85"	22-6030	22-6035	22-2259
2001	2014	GMC	Sierra 2500/3500HD Crew Cab (Excl. Canadian Diesel)	Body Mnt	91"	22-6040	22-6045	22-1075
2015	2019	GMC	Sierra 2500/3500HD Crew Cab	Rocker Pnl	85"	22-6030	22-6035	22-2019
2015	2019	GMC	Sierra 2500/3500HD Double Cab	Rocker Pnl	75"	22-6020	22-6029	22-2019
1999	2014	GMC	Sierra 2500/3500HD Ext Cab (Excl. Canadian Diesel)	Body Mnt	75"	22-6020	22-6029	22-1069
1999	2014	GMC	Sierra 2500/3500HD Reg Cab (Excl. Canadian Diesel)	Body Mnt	59"	22-6000	22-6005	22-1065
2015	2019	GMC	Sierra 2500/3500HD Reg Cab	Rocker Pnl	85"	22-6030	22-6035	22-2005
2000	2004	GMC	Yukon 4Dr (Excl. 2004 Z71)	Body Mnt	75"	22-6020	22-6029	22-1139
2005	2014	GMC	Yukon 4Dr (Excl. Hybrid & Z71)	Rocker Pnl	75"	22-6020	22-6029	22-1536
2005	2014	GMC	Yukon XL (Excl. Hybrid & Z71)	Rocker Pnl	91"	22-6040	22-6045	22-1539
2006	2014	Honda	Ridgeline	Rocker Pnl	85"	22-6030	22-6035	22-1675
2004	2010	Infiniti	QX5 (Excl. Sport)	Rocker Pnl	75"	22-6020	22-6029	22-1419
2006	2008	Isuzu	i-Series Crew Cab	Body Mnt	75"	22-6020	22-6029	22-1399
2011	2017	Jeep	Grand Cherokee	Rocker Pnl	75"	22-6020	22-6029	22-1985
2007	2010	Jeep	Wrangler JK 2Dr	Frame	59"	22-6000	22-6005	22-1725
2006	2008	Lincoln	Mark LT	Rocker Pnl	85"	22-6030	22-6035	22-1889
2006	2010	Mercury	Mountaineer ³	Frame	75"	22-6020	22-6029	22-1675
2004	2015	Nissan	Armada	Rocker Pnl	75"	22-6020	22-6029	22-1419
2005	2021	Nissan	Frontier Crew Cab	Rocker Pnl	75"	22-6020	22-6029	22-1529
2017	2023	Nissan	Titan	Rocker Pnl	85"	22-6030	22-6035	22-2229
2004	2015	Nissan	Titan Crew Cab	Rocker Pnl	85"	22-6030	22-6035	22-1419
2004	2015	Nissan	Titan Ext. King Cab	Rocker Pnl	75"	22-6020	22-6029	22-1419
2017	2023	Nissan	Titan XD Crew Cab	Rocker Pnl	85"	22-6030	22-6035	22-2229
2004	2009	Pontiac	Torrent	Rocker Pnl	75"	22-6020	22-6029	22-1779
2019	2023	Ram	1500 Classic Crew Cab	Rocker Pnl	85"	22-6030	22-6035	22-1985
2019	2023	Ram	1500 Classic Quad Cab ¹	Rocker Pnl	75"	22-6020	22-6029	22-1985
2019	2023	Ram	1500 Classic Reg Cab	Rocker Pnl	59"	22-6000	22-6005	22-1899

CONTINUED ON NEXT PAGE ➔

PREMIER 6 OVAL NERF STEP BARS CONTINUED

304 STAINLESS STEEL / BLACK POWDER COAT

START	END	MAKE	MODEL	MOUNTING	LENGTH (IN.)	POLISHED	BLACK	REQUIRED MOUNT KIT
2009	2018	Ram	1500 Crew Cab	Rocker Pkt	85"	22-6030	22-6035	22-1905
2016	2023	Ram	1500 Crew Cab (Excl. Classic)	Rocker Pkt	89"	22-6030	22-6035	22-2245
2009	2018	Ram	1500 Quad Cab ¹⁰	Rocker Pkt	75"	22-6020	22-6025	22-1905
2019	2023	Ram	1500 Quad Cab (Excl. Classic)	Rocker Pkt	75"	22-6020	22-6025	22-2245
2009	2018	Ram	1500 Reg Cab	Rocker Pkt	53"	22-6000	22-6005	22-1895
2010	2023	Ram	2500/3500 Crew Cab ¹⁰	Rocker Pkt	89"	22-6030	22-6035	22-1905
2010	2023	Ram	2500/3500 Reg Cab (Excl. Daytona) ¹⁰	Rocker Pkt	53"	22-6000	22-6005	22-1895
2007	2009	Saturn	Outlook	Rocker Pkt	75"	22-6020	22-6025	22-1795
2006	2007	Saturn	Vue	Rocker Pkt	75"	22-6020	22-6025	22-1775
2006	2023	Toyota	Tacoma Double Cab	Rocker Pkt	89"	22-6030	22-6035	22-1475
1999	2008	Toyota	Tundra Access Cab	Frame	75"	22-6020	22-6025	22-1345
2007	2021	Toyota	Tundra CrewMax	Rocker Pkt	91"	22-6040	22-6045	22-1665
2004	2008	Toyota	Tundra Double Cab	Frame	85"	22-6030	22-6035	22-1345
2007	2021	Toyota	Tundra Double Cab	Rocker Pkt	75"	22-6020	22-6025	22-1665

FOOTNOTES: 1. Requires Minor Drilling For 2008 And Older. 3. Not Compatible On Vehicles With Power Retracting Boards If Equipped. 9. Not Compatible With OEM Skirt Cladding. 10. Excludes Chassis Cab With Diesel Exhaust Fluid (DEF) Tank Vehicles.



WESTIN[™] NERF STEP BARS

E-SERIES 3 NERF STEP BARS

304 STAINLESS STEEL / BLACK POWDER COAT

- ▶ Mount kit included
- ▶ 3" round step bars
- ▶ Protects vehicle rocker panels from potential damage
- ▶ Economical step-up solution
- ▶ Vehicle specific applications
- ▶ Injection molded polymer step pad
- ▶ Recessed step area
- ▶ Bolt-on installation on most applications

FINISH: Polished

MATERIAL: 304 Stainless Steel

WARRANTY: Lifetime

FINISH: Black Powder Coat

MATERIAL: E-Coated Steel

WARRANTY: 3-Year

RECESSED STEP AREA

INJECTION MOLDED
POLYMER STEP PAD

3" ROUND STEP BARS



MOLDED POLYMER STEP PAD
PN# 23-3002

START	END	MAKE	MODEL	MOUNTING	POLISHED	BLACK
2003	2017	Buick	Enclave	Rocker Pn	23-3380	—
2004	2007	Buick	Rainier	Rocker Pn	23-2920	23-2925
2002	2006	Chevrolet	Avalanche 1500 (W/ Cladding)	Body Mnt	23-3020	—
2003	2019	Chevrolet	Avalanche 1500 (W/D Cladding)	Body Mnt	23-3990	23-3995
1992	1994	Chevrolet	Blazer (Full Size) 2Dr	Body Mnt	23-3500	23-3505
1998	2000	Chevrolet	C/K 1500/2500/3500 Reg Cab (Excl. 1999-2000 Silverado 1500/2500)	Rocker Pn	23-9500	23-9505
2004	2012	Chevrolet	Colorado Crew Cab	Rocker Pn	23-3150	23-3155
2016	2023	Chevrolet	Colorado Crew Cab	Rocker Pn	23-4010	23-4015
2004	2012	Chevrolet	Colorado Ext Cab	Rocker Pn	23-3140	—
2016	2020	Chevrolet	Colorado Ext Cab	Rocker Pn	23-4000	23-4005
2004	2012	Chevrolet	Colorado Reg Cab	Rocker Pn	23-3130	23-3135
1999	2019	Chevrolet	Silverado 1500 Crew Cab	Body Mnt	23-1950	23-1955
2014	2018	Chevrolet	Silverado 1500 Crew Cab	Body Mnt	23-3820	23-3825
2014	2018	Chevrolet	Silverado 1500 Crew Cab	Rocker Pn	23-3720	23-3725
2019	2023	Chevrolet	Silverado 1500 Crew Cab (Excl. 2019 LD)	Body Mnt	23-4130	23-4135
2014	2018	Chevrolet	Silverado 1500 Double Cab	Body Mnt	23-3810	23-3815
2014	2018	Chevrolet	Silverado 1500 Double Cab	Rocker Pn	23-3710	23-3715
2019	2020	Chevrolet	Silverado 1500 Double Cab (Excl. 2019 LD)	Body Mnt	23-4120	23-4125
1999	2013	Chevrolet	Silverado 1500 Ext Cab (Excl. 2002 Body Sold In 2001)	Body Mnt	23-1680	23-1685
1999	2019	Chevrolet	Silverado 1500 Reg Cab	Body Mnt	23-1400	23-1405
2014	2018	Chevrolet	Silverado 1500 Reg Cab	Rocker Pn	—	23-3705
2019	2020	Chevrolet	Silverado 1500 Reg Cab	Body Mnt	23-4110	23-4115
2001	2006	Chevrolet	Silverado 1500HD Crew Cab	Body Mnt	23-3860	23-3865
2001	2014	Chevrolet	Silverado 2500/3500HD Crew Cab	Body Mnt	23-1980	23-1985
2016	2019	Chevrolet	Silverado 2500/3500 Crew Cab	Body Mnt	23-1950	23-1955
2016	2019	Chevrolet	Silverado 2500/3500HD Double Cab	Body Mnt	23-3880	23-3885
2016	2019	Chevrolet	Silverado 2500/3500HD Double Cab	Rocker Pn	23-3710	23-3715

CONTINUED ON NEXT PAGE →

E-SERIES 3 NERF STEP BARS CONTINUED

304 STAINLESS STEEL / BLACK POWDER COAT

START	END	MAKE	MODEL	MOUNTING	POLISHED	BLACK
2001	2014	Chevrolet	Silverado 2500/3500HD Ext Cab	Body Mnt	23-1680	23-1685
2001	2014	Chevrolet	Silverado 2500/3500HD Reg Cab	Body Mnt	23-1400	23-1405
2016	2019	Chevrolet	Silverado 2500/3500HD Reg Cab	Body Mnt	23-3848	23-3845
2016	2019	Chevrolet	Silverado 2500/3500HD Reg Cab	Rocker Pni	—	23-3705
1999	2004	Chevrolet	Silverado 2500LD Ext Cab	Body Mnt	23-1680	23-1685
1999	2004	Chevrolet	Silverado 2500LD Reg Cab	Body Mnt	23-1400	23-1405
2019	2019	Chevrolet	Silverado LD Double Cab	Body Mnt	23-3810	23-3815
2019	2019	Chevrolet	Silverado LD Double Cab	Rocker Pni	23-3710	23-3715
2000	2014	Chevrolet	Suburban 1500 (Excl. 2002-2009 Hybrid & Z71)	Body Mnt	23-2990	23-2995
1995	1999	Chevrolet	Tahoe 2Dr	Body Mnt	23-0500	23-0505
2000	2014	Chevrolet	Tahoe 4Dr (Excl. 2002-2009 Hybrid & Z71)	Body Mnt	23-3000	23-3005
2002	2009	Chevrolet	Trailblazer	Rocker Pni	23-2130	23-2135
2009	2017	Chevrolet	Traverse	Rocker Pni	23-3280	—
2006	2009	Chrysler	Aspen	Body Mnt	23-2630	23-2635
2006	2011	Dodge	Dakota Club Cab	Body Mnt	23-2800	23-2805
2006	2011	Dodge	Dakota Quad Cab	Body Mnt	23-2790	23-2795
2011	2017	Dodge	Durango 4x4	Rocker Pni	23-3620	23-3625
2004	2008	Dodge	Durango 4Dr	Body Mnt	23-2630	23-2635
2007	2012	Dodge	Nitro	Rocker Pni	—	23-3405
2009	2018	Dodge	Ram 1500 Crew Cab	Rocker Pni	23-3560	23-3565
2009	2018	Dodge	Ram 1500 Quad Cab	Rocker Pni	23-3550	23-3555
2002	2008	Dodge	Ram 1500 Quad Cab (Excl. Daytona, Rumble Bee, & SRT-10)	Body Mnt	23-2310	23-2315
2009	2018	Dodge	Ram 1500 Reg Cab	Rocker Pni	23-3540	23-3545
2002	2008	Dodge	Ram 1500 Reg Cab (Excl. Daytona, Rumble Bee, & SRT-10)	Body Mnt	23-2320	23-2325
2010	2018	Dodge	Ram 2500/3500 Crew Cab 4x4	Rocker Pni	23-3860	23-3865
2010	2018	Dodge	Ram 2500/3500 Mega Cab 4x4	Rocker Pni	23-3870	23-3875
2003	2009	Dodge	Ram 2500/3500 Quad Cab 4x4	Body Mnt	23-2310	23-2315
2003	2009	Dodge	Ram 2500/3500 Reg Cab 4x4	Body Mnt	23-2320	23-2325
2010	2018	Dodge	Ram 2500/3500 Reg Cab 4x4	Rocker Pni	23-3840	23-3845
2003	2009	Dodge	Ram 4500/5500 Quad Cab 4x4	Rocker Pni	23-2310	23-2315
2003	2009	Dodge	Ram 4500/5500 Reg Cab 4x4	Rocker Pni	23-2320	23-2325
2006	2009	Dodge	Ram Mega Cab	Body Mnt	23-2900	23-2905
1980	1996	Ford	Bronco (Full Side)	Body Frame	23-0630	23-0635
2007	2014	Ford	Edge (Excl. Sport/Excl. EcoBoost) 4x4	Rocker Pni	23-3440	—
2010	2019	Ford	Escape	Rocker Pni	23-3790	—
1997	2014	Ford	Excursion	Rocker Pni	23-1925	23-1930
2008	2010	Ford	Explorer 4Dr	Rocker Pni	23-3040	23-3045
2011	2019	Ford	Explorer 4Dr 4x4	Rocker Pni	23-3600	23-3605
2009	2014	Ford	F-150 Reg Cab	Rocker Pni	23-3500	23-3505
2016	2023	Ford	F-150 Reg Cab	Rocker Pni	23-3920	23-3925
2004	2008	Ford	F-150 Reg Cab (Excl. Heritage)	Rocker Pni	23-2340	23-2345
2009	2014	Ford	F-150 SuperCab	Rocker Pni	23-3510	23-3515
2016	2023	Ford	F-150 SuperCab	Rocker Pni	23-3930	23-3935
2004	2008	Ford	F-150 SuperCab (Excl. Heritage)	Rocker Pni	23-2350	23-2355
2016	2023	Ford	F-150 SuperCrew	Rocker Pni	23-3940	23-3945
2009	2014	Ford	F-150 SuperCrew	Rocker Pni	23-3520	23-3525
2004	2008	Ford	F-150 SuperCrew (Excl. Heritage)	Rocker Pni	23-2360	23-2365
2001	2004	Ford	F-150 SuperCrew 4Dr (2004 Heritage Only)	Rocker Pni	23-1830	23-1835
1997	2004	Ford	F-150 250LD Reg Cab (2004 Heritage Only)	Rocker Pni	23-1100	23-1105
1999	2004	Ford	F-150 250LD SuperCab 4Dr (2004 Heritage Only) 4x4	Rocker Pni	23-1430	23-1435
1980	1997	Ford	F-150 F-250 F-350 Reg Cab (HD Only)	Body Frame	23-0630	23-0635
2017	2023	Ford	F-250 350 Crew Cab	Rocker Pni	23-3940	23-3945
2017	2023	Ford	F-250 350 Reg Cab	Rocker Pni	23-3920	23-3925
2017	2023	Ford	F-250 350 SuperCab	Rocker Pni	23-3930	23-3935
1999	2016	Ford	F-250 350 450 550 Crew Cab	Rocker Pni	23-1120	23-1125
1999	2016	Ford	F-250 350 450 550 Reg Cab	Rocker Pni	23-1120	23-1125
1999	2016	Ford	F-250 350 450 550 SuperCab 4Dr	Rocker Pni	23-1210	23-1215
1990	2011	Ford	Ranger SuperCab 2Dr 4x4	Rocker Pni	23-2110	23-2115
1999	2011	Ford	Ranger SuperCab 4Dr	Rocker Pni	23-1650	23-1655
2019	2023	Ford	Ranger SuperCrew	Rocker Pni	23-4150	23-4155
2007	2017	GMC	Acadia (Excl. Denali)	Rocker Pni	23-3280	—
2004	2012	GMC	Canyon Crew Cab	Rocker Pni	23-3160	23-3165
2016	2023	GMC	Canyon Crew Cab	Rocker Pni	23-4010	23-4015
2004	2012	GMC	Canyon Ext Cab	Rocker Pni	23-3140	—
2016	2023	GMC	Canyon Ext Cab	Rocker Pni	23-4000	23-4005
2004	2012	GMC	Canyon Reg Cab	Rocker Pni	23-3130	23-3135
2002	2009	GMC	Envoy	Rocker Pni	23-2120	23-2125
2007	2010	GMC	Outlook	Rocker Pni	23-3380	—
1999	2013	GMC	Sierra 1500 Crew Cab	Body Mnt	23-1990	23-1995
2014	2018	GMC	Sierra 1500 Crew Cab	Rocker Pni	23-3720	23-3725
2014	2018	GMC	Sierra 1500 Crew Cab	Body Mnt	23-3820	23-3825
2016	2023	GMC	Sierra 1500 Crew Cab (Excl. 2019 Limited)	Body Mnt	23-4130	23-4135
2014	2018	GMC	Sierra 1500 Double Cab	Rocker Pni	23-3710	23-3715
2014	2018	GMC	Sierra 1500 Double Cab	Body Mnt	23-3810	23-3815
2019	2023	GMC	Sierra 1500 Double Cab (Excl. 2019 Limited)	Body Mnt	23-4120	23-4125
1999	2013	GMC	Sierra 1500 Ext Cab (Excl. 2002 Body Sold in 2001)	Body Mnt	23-1690	23-1695
2016	2019	GMC	Sierra 1500 Limited Double Cab	Rocker Pni	23-3710	23-3715
2016	2019	GMC	Sierra 1500 Limited Double Cab	Body Mnt	23-3810	23-3815
1999	2010	GMC	Sierra 1500 Reg Cab	Body Mnt	23-1400	23-1405
2014	2018	GMC	Sierra 1500 Reg Cab	Rocker Pni	—	23-3705
2019	2023	GMC	Sierra 1500 Reg Cab	Body Mnt	23-4110	23-4115
2001	2006	GMC	Sierra 1500HD Crew Cab	Body Mnt	23-1950	23-1955
2016	2019	GMC	Sierra 2500/3500 Crew Cab	Body Mnt	23-3860	23-3865

CONTINUED ON NEXT PAGE →

E-SERIES 3 NERF STEP BARS CONTINUED

304 STAINLESS STEEL / BLACK POWDER COAT

START	END	MAKE	MODEL	MOUNTING	POLISHED	BLACK
2001	2014	GMC	Sierra 2500/3500HD Crew Cab	Body Mnt	23-1980	23-1985
2015	2019	GMC	Sierra 2500/3500HD Double Cab	Rocker Pnt	23-3710	23-3715
2015	2019	GMC	Sierra 2500/3500HD Double Cab	Body Mnt	23-3850	23-3855
2001	2014	GMC	Sierra 2500/3500HD Ext Cab	Body Mnt	23-1680	23-1685
2001	2014	GMC	Sierra 2500/3500HD Reg Cab	Body Mnt	23-1400	23-1405
2015	2019	GMC	Sierra 2500/3500HD Reg Cab	Rocker Pnt	—	23-3705
2015	2019	GMC	Sierra 2500/3500HD Reg Cab	Body Mnt	23-3840	23-3845
1999	2004	GMC	Sierra 2500LD Ext Cab	Body Mnt	23-1680	23-1685
1999	2004	GMC	Sierra 2500LD Reg Cab	Body Mnt	23-1400	23-1405
1992	1999	GMC	Yukon 2Dr	Rocker Pnt	23-0800	23-0805
2000	2014	GMC	Yukon 4Dr (Excl. 2002-2010 Hybrid & Z71)	Rocker Pnt	23-3000	23-3005
2000	2019	GMC	Yukon XL 1/2 Ton (Excl. 2002-2008 Hybrid & Z71)	Body Mnt	23-2990	23-2995
2005	2014	Honda	Rogue	Rocker Pnt	23-2180	23-2185
2006	2010	Hummer	H3	Frame Mnt	23-2860	23-2865
1999.5	2004	Infiniti	QX4	Frame Mnt	—	23-1555
2003	2008	Isuzu	Ascender (5 Passenger)	Rocker Pnt	23-2130	23-2135
2005	2008	Isuzu	i-Series Crew Cab	Rocker Pnt	23-3150	23-3155
2006	2008	Isuzu	i-Series Ext Cab	Rocker Pnt	23-3140	—
2006	2008	Isuzu	i-Series Reg Cab	Rocker Pnt	23-3130	23-3135
2006	2010	Jeep	Commander	Rocker Pnt	23-2970	23-2975
2005	2010	Jeep	Grand Cherokee	Rocker Pnt	23-2970	23-2975
2011	2017	Jeep	Grand Cherokee 11.5	Rocker Pnt	23-3610	23-3615
2007	2018	Jeep	Wrangler JK 2Dr	Frame Mnt	—	23-3315
2007	2018	Jeep	Wrangler JK Unlimited 4Dr	Frame Mnt	—	23-3295
2013	2023	Jeep	Wrangler JL Unlimited 4Dr	Frame Mnt	—	23-4065
1997	2006	Jeep	Wrangler TJ (Excl. 2004-2006 Unlimited)	Frame Mnt	23-0970	23-0975
2004	2008	Lincoln	Mark LT	Rocker Pnt	23-2360	23-2365
2007	2016	Lincoln	MKX (Excl. EcoBoost SM)	Rocker Pnt	23-3440	—
1998	2010	Mazda	B-Series Pickup Extra Cab 2Dr ¹	Rocker Pnt	23-2110	23-2115
1998	2010	Mazda	B-Series Pickup Extra Cab 4Dr	Rocker Pnt	23-1950	23-1955
2004	2021	Nissan	Frontier Crew Cab	Rocker Pnt	23-2760	23-2765
1999.5	2004	Nissan	Pathfinder	Frame Mnt	—	23-1885
2004	2016	Nissan	Titan Crew Cab	Body Mnt	—	23-2635
2004	2016	Nissan	Titan King Cab	Body Mnt	—	23-2555
2016	2023	Nissan	Titan XD Crew Cab	Rocker Pnt	23-4020	23-4025
2002	2004	Oldsmobile	Bravada 4Dr	Rocker Pnt	23-2130	23-2135
2019	2023	Ram	1500 Classic Crew Cab	Rocker Pnt	23-3860	23-3865
2018	2023	Ram	1500 Classic Quad Cab	Rocker Pnt	23-3850	23-3855
2019	2023	Ram	1500 Classic Reg Cab	Rocker Pnt	23-3540	23-3545
2009	2018	Ram	1500 Crew Cab	Rocker Pnt	23-3560	23-3565
2019	2023	Ram	1500 Crew Cab (Excl. Classic)	Rocker Pnt	23-4000	23-4005
2009	2018	Ram	1500 Quad Cab	Rocker Pnt	23-3550	23-3555
2019	2023	Ram	1500 Quad Cab (Excl. Classic)	Rocker Pnt	23-4090	23-4095
2009	2018	Ram	1500 Reg Cab	Rocker Pnt	23-3540	23-3545
2010	2023	Ram	2500/3500 Crew Cab ¹⁴	Rocker Pnt	23-3860	23-3865
2010	2023	Ram	2500/3500 Reg Cab ¹⁴	Rocker Pnt	23-3540	23-3545
2010	2023	Toyota	4Runner Limited/Nightshade/TRD Sport (Excl. 40th Anniversary & Premium/TRD Off-Road & Pro/Trail Venture)	Rocker Pnt	—	23-3835
2014	2023	Toyota	4Runner 40th Anniversary & Premium/TRD Off-Road & Pro/Trail Venture (Excl. Limited/Nightshade/TRD Sport)	Rocker Pnt	—	23-3835
2010	2017	Toyota	4Runner Trail (Excl. Limited)	Rocker Pnt	—	23-3835
2005	2023	Toyota	Tacoma Access Cab	Rocker Pnt	23-2670	23-2675
2005	2023	Toyota	Tacoma Double Cab	Rocker Pnt	23-2770	23-2775
2005	2023	Toyota	Tacoma Reg Cab	Rocker Pnt	23-3690	23-3695
1999	2006	Toyota	Tundra Access Cab	Frame Mnt	23-2310	23-2315
2007	2021	Toyota	Tundra CrewMax	Rocker Pnt	23-3250	23-3255
2004	2006	Toyota	Tundra Double Cab	Frame Mnt	23-2400	23-2405
2007	2021	Toyota	Tundra Double Cab	Rocker Pnt	23-3240	23-3245
2007	2017	Toyota	Tundra Reg Cab	Rocker Pnt	—	23-3265

FOOTNOTES:

1. Requires Minor Drilling. 4. Requires Relocating The Brake Line For Short Bed Vehicles. 6. Not Compatible On Vehicles With Power Retracting Boards If Equipped. 11. Requires Minor Trimming Of Driver/Left Side Splash Shield. 12. Not Compatible With OEM Skirt Cladding. 13. Excludes Chassis Cab With Diesel Exhaust Fluid (DEF) Tank Vehicles. 14. Includes Bracket Kit Part #25-2716

SIGNATURE 3 NERF STEP BARS

CHROME PLATED STEEL / BLACK GALVANIZED STEEL POWDER COAT

- ▶ Mount kit included
- ▶ Made from corrosion resistant coated steel
- ▶ Protects vehicle rocker panels from potential damage
- ▶ Superior mounting design
- ▶ Recessed step area
- ▶ Injection molded polymer step pad
- ▶ Heavy wall tube
- ▶ Bolt-on installation on most applications

FINISH: Chrome

MATERIAL: E-Coated Steel

WARRANTY: 3-Year

FINISH: Black Powder Coat

MATERIAL: Galvanized Steel

WARRANTY: 5-Year

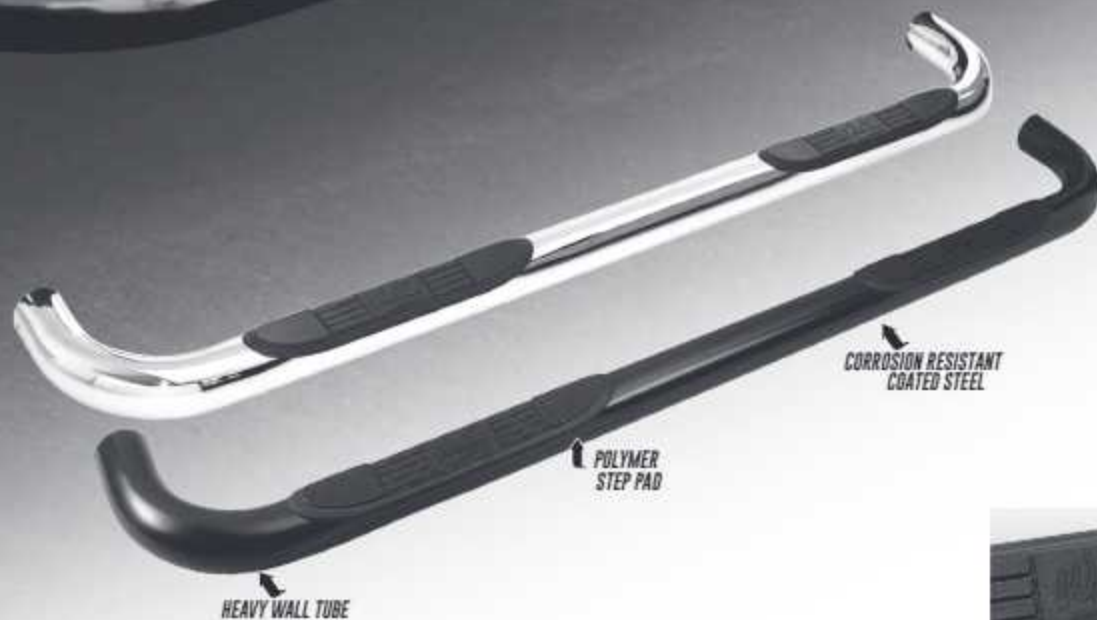

MOLDED POLYMER STEP PAD
REPLACEMENT PN# 25-0001

START	END	MAKE	MODEL	MOUNTING	CHROME	BLACK
1992	1994	Chevrolet	Blazer Full Size 2Dr	Body Mnt	—	25-3608
1992	2000	Chevrolet	C/K 1500/2500/3500 Crew Cab (Excl. 1999-2000 Silverado 1500/2500)	Rocker Pnl	—	25-0055
1993	1998	Chevrolet	C/K 1500/2500/3500 Ext Cab 2Dr	Rocker Pnl	—	25-0639
1993	1998	Chevrolet	C/K 1500/2500/3500 Reg Cab	Rocker Pnl	—	25-0605
2016	2022	Chevrolet	Colorado Ext Cab	Rocker Pnl	25-4000	25-4000
1995	2004	Chevrolet	S-10 Blazer 4Dr	Body Mnt	—	25-0735
1999	2013	Chevrolet	Silverado 1500 Crew Cab	Body Mnt	—	25-1955
1999	2013	Chevrolet	Silverado 1500 Ext Cab (Excl. 2002 Body Sold in 2001)	Body Mnt	25-1680	25-1685
1999	2013	Chevrolet	Silverado 1500 Reg Cab	Body Mnt	—	25-1405
2001	2008	Chevrolet	Silverado 1500HD Crew Cab	Body Mnt	—	25-1955
2001	2014	Chevrolet	Silverado 2500/3500HD Crew Cab	Body Mnt	—	25-1955
2015	2019	Chevrolet	Silverado 2500/3500HD Double Cab	Body Mnt	25-3850	—
2001	2014	Chevrolet	Silverado 2500/3500HD Ext Cab	Body Mnt	25-1630	25-1635
2001	2014	Chevrolet	Silverado 2500/3500HD Reg Cab	Body Mnt	—	25-1405
2015	2019	Chevrolet	Silverado 2500/3500HD Reg Cab	Body Mnt	25-3840	—
1999	2004	Chevrolet	Silverado 2500LD Ext Cab	Body Mnt	25-1680	25-1685
1999	2004	Chevrolet	Silverado 2500LD Reg Cab	Body Mnt	—	25-1405
1982	2004	Chevrolet	S-Series Ext Cab 2 & 3Dr	Body Mnt	—	25-0675
1992	1999	Chevrolet	Suburban (Excl. 1500 4WD)	Body Mnt	—	25-0645
1995	1999	Chevrolet	Tahoe 2Dr	Body Mnt	—	25-0505
1997	2004	Dodge	Dakota Club Cab	Body Mnt	—	25-0950

CONTINUED ON NEXT PAGE →

SIGNATURE 3 NERF STEP BARS CONTINUED

CHROME PLATED STEEL / BLACK GALVANIZED STEEL POWDER COAT

START	END	MAKE	MODEL	MOUNTING	CHROME	BLACK
1994	2001	Dodge	Ram 1500 Club Cab	Body Mnt	—	25-2685
2009	2018	Dodge	Ram 1500 Crew Cab	Rocker Pnt	25-3560	25-3565
1998	2001	Dodge	Ram 1500 Quad Cab	Body Mnt	—	25-2245
2002	2008	Dodge	Ram 1500 Quad Cab (Excl. Daytona, Rumble Bee, & SRT-10)	Body Mnt	—	25-2315
2009	2018	Dodge	Ram 1500 Quad Cab	Rocker Pnt	—	25-3595
1994	2001	Dodge	Ram 1500 Reg Cab	Body Mnt	—	25-2655
2009	2018	Dodge	Ram 1500 Reg Cab	Rocker Pnt	—	25-3545
1994	2002	Dodge	Ram 2500/3500 Club Cab	Body Mnt	—	25-2685
2010	2023	Dodge	Ram 2500/3500 Crew Cab ¹	Rocker Pnt	25-3560	25-3565
1998	2002	Dodge	Ram 2500/3500 Quad Cab ¹	Body Mnt	—	25-1245
2003	2008	Dodge	Ram 2500/3500 Quad Cab ¹	Body Mnt	—	25-2315
1994	2002	Dodge	Ram 2500/3500 Reg Cab ¹	Body Mnt	—	25-2655
2010	2023	Dodge	Ram 2500/3500 Reg Cab ¹	Rocker Pnt	—	25-3545
2003	2009	Dodge	Ram 4500/5500 Quad Cab ¹	Rocker Pnt	—	25-2315
1980	1998	Ford	Bronco (Full Size)	Body Frame	25-0830	—
2001	2004	Ford	Explorer 2Dr	Rocker Pnt	—	25-1925
2001	2006	Ford	Explorer Sport Trac	Rocker Pnt	—	25-1895
2015	2023	Ford	F-150 Reg Cab	Rocker Pnt	—	25-1925
2015	2023	Ford	F-150 SuperCab	Rocker Pnt	25-3930	25-3935
1999	2004	Ford	F-150 250LD SuperCab 4Dr (2004 Heritage Only) ^{1, 2}	Rocker Pnt	—	25-1435
2017	2023	Ford	F-250/350 Reg Cab	Rocker Pnt	—	25-1925
2017	2023	Ford	F-250/350 SuperCab	Rocker Pnt	25-3930	25-3935
1999	2018	Ford	F-250/350/450/550 SuperCab 4Dr	Rocker Pnt	—	25-1315
1999	2018	Ford	F-250/350/450/550HD Reg Cab	Rocker Pnt	25-1320	25-1325
1980	1998	Ford	F-Series Pickup Reg Cab (HD Only)	Body Frame	25-0830	—
1980	1998	Ford	F-Series Pickup SuperCab 2Dr (HD Only)	Body Frame	—	25-0625
1982	1997	Ford	Ranger Ext Cab	Body Mnt	—	25-0595
1982	1997	Ford	Ranger Reg Cab	Body Mnt	—	25-0565
1998	2011	Ford	Ranger Reg Cab ¹	Rocker Pnt	—	25-2185
1998	2010	Ford	Ranger SuperCab 2Dr ¹	Rocker Pnt	—	25-2115
2015	2022	GMC	Canyon Ext Cab	Rocker Pnt	25-4000	25-4005
1995	2004	GMC	S-15 Jimmy 4Dr	Body Mnt	—	25-0735
1999	2010	GMC	Sierra 1500 Crew Cab	Body Mnt	—	25-1955
1999	2010	GMC	Sierra 1500 Ext Cab (Excl. 2002 Body Sold in 2001)	Body Mnt	25-1680	25-1685
1999	2010	GMC	Sierra 1500 Reg Cab	Body Mnt	—	25-1405
2001	2006	GMC	Sierra 1500HD Crew Cab	Body Mnt	—	25-1955
2001	2014	GMC	Sierra 2500/3500HD Crew Cab	Body Mnt	—	25-1955
2015	2019	GMC	Sierra 2500/3500HD Double Cab	Body Mnt	25-3850	—
2001	2014	GMC	Sierra 2500/3500HD Ext Cab	Body Mnt	25-1680	25-1685
2001	2014	GMC	Sierra 2500/3500HD Reg Cab	Body Mnt	—	25-1405
2015	2019	GMC	Sierra 2500/3500HD Reg Cab	Body Mnt	25-3840	—
1999	2004	GMC	Sierra 2500LD Ext Cab	Body Mnt	25-1680	25-1685
1999	2004	GMC	Sierra 2500LD Reg Cab	Body Mnt	—	25-1405
1982	2004	GMC	Sonoma Ext Cab 2 & 3Dr	Body Mnt	—	25-0675
1992	1999	GMC	Yukon 2Dr	Rocker Pnt	—	25-0805
1998	2003	Isuzu	Hombre PU Ext Cab	Body Mnt	—	25-0675
1999	2004	Jeep	Grand Cherokee (Excl. Overland)	Body Mnt	—	25-1475
2004	2008	Jeep	Wrangler Unlimited	Frame Mnt	—	25-2855
1997	2008	Jeep	Wrangler TJ (Excl. Unlimited)	Frame Mnt	—	25-0975
1998	2010	Mazda	B-Series Pickup Extra Cab 2Dr ¹	Rocker Pnt	—	25-2115
1994	1997	Mazda	B-Series Pickup Reg Cab ¹	Body Mnt	—	25-0665
1998	2011	Mazda	B-Series Pickup Reg Cab ¹	Rocker Pnt	—	25-2105
2005	2021	Nissan	Frontier Crew Cab	Rocker Pnt	—	25-2755
2005	2021	Nissan	Frontier King Cab	Rocker Pnt	—	25-2735
1998	2001	Oldsmobile	Brevard 4Dr (Excl. 2002 Body Sold in 2001)	Body Mnt	—	25-0735
2019	2023	Ram	1500 Classic Crew Cab	Rocker Pnt	25-3560	25-3565
2019	2023	Ram	1500 Classic Quad Cab	Rocker Pnt	—	25-3555
2019	2023	Ram	1500 Classic Reg Cab	Rocker Pnt	—	25-3545
2009	2018	Ram	1500 Crew Cab	Rocker Pnt	25-3560	25-3565
2009	2018	Ram	1500 Quad Cab	Rocker Pnt	—	25-3555
2009	2018	Ram	1500 Reg Cab	Rocker Pnt	—	25-3545
2010	2023	Ram	2500/3500 Crew Cab ¹	Rocker Pnt	25-3560	25-3565
2010	2023	Ram	2500/3500 Reg Cab ¹	Rocker Pnt	—	25-3545
1996	2002	Toyota	4Runner 4Dr	Frame Mnt	—	25-1455
1989	1994	Toyota	Pickup Reg Cab	Frame Mnt	—	25-0575
2001	2004	Toyota	Tacoma Double Cab	Body Mnt	—	25-2015
1995	2004	Toyota	Tacoma Reg Cab 4WD or Pre-Runner (Excl. Non Pre-Runner 2WD)	Frame Mnt	—	25-0835

FOOTNOTES:

1. Requires Minor Drilling. 7. Requires Relocating The Brake Line For Short Bed Vehicles. Bracket 25-2718 Included In Kit. 16. Excludes Chassis Cab-With Diesel Exhaust Fluid (DEF) Tank Vehicles. 17. Includes Bracket Kit Part# 25-2718



NEW! - Pro-e Running Boards44



SG6 LED Running Boards45



SG6 Running Boards47



Grate Steps Running Boards50



Thrasher Running Boards53



Sure-Grip Running Boards54



Molded Running Boards57



WESTIN®

RUNNING BOARDS

WESTIN® SUPERWINCH



Pro-e Running Boards shown open and closed



Pro-e Running Boards shown on Toyota Tacoma

NEW! PRO-e RUNNING BOARDS

TEXTURED BLACK

- » Running board automatically deploys when any door is open then retracts when door is close
- » 2 waterproof IP68 rated motors per side
- » Included LED lights illuminate step surface
- » Protects vehicle rocker panels from potential damage
- » 6" wide durable aluminum running boards
- » 600 lbs. weight capacity (300 lbs. per side)
- » Corrosion resistant aluminum boards
- » Bolt-on installation - no drilling required
- » Hardware and mounting brackets included
- » Available in black powder coat finish



FINISH: Textured Black Powder Coat

MATERIAL: Aluminum

WARRANTY: 5-Year

LED LIGHT WARRANTY: Limited Lifetime

START	END	MAKE	MODEL	LENGTH (IN.)	TEXTURED BLACK
2015	2023	Chevrolet	Colorado Crew Cab	—	29-24015
2019	2023	Chevrolet	Silverado 1500 Crew Cab (Excl. 2019 LD)	81"	29-24138
2020	2023	Chevrolet	Silverado 2500/3500 Crew Cab	82"	29-24138
2009	2018	Dodge	Ram 1500 Crew Cab	—	29-23565
2010	2023	Dodge	Ram 2500/3500 Crew Cab ¹	—	29-23565
2021	2023	Ford	Bronco 2Dr (Excl. Bronco Sport)	57"	29-24188
2021	2023	Ford	Bronco 4Dr (Excl. Bronco Sport)	74"	29-24198
2015	2023	Ford	F-150 SuperCrew	81"	29-23945
2017	2023	Ford	F-250/350 Crew Cab	82"	29-23945
2019	2023	Ford	Ranger SuperCrew	—	29-24198
2015	2023	GMC	Canyon Crew Cab	—	29-24015
2019	2023	GMC	Sierra 1500 Crew Cab (Excl. 2019 Limited)	81"	29-24138
2020	2023	GMC	Sierra 2500/3500 Crew Cab	—	29-24138
2020	2023	Jeep	Gladiator	—	29-24168
2018	2023	Jeep	Wrangler JL Unlimited 4Dr	—	29-24065
2019	2023	Ram	1500 Classic Crew Cab	—	29-23565
2009	2018	Ram	1500 Crew Cab	—	29-23565
2019	2023	Ram	1500 Crew Cab (Excl. Classic)	81"	29-24088
2010	2023	Ram	2500/3500 Crew Cab ¹	—	29-23565
2010	2017	Toyota	4Runner Trail Edition (Excl. Limited)	82"	29-23835
2014	2023	Toyota	4Runner 4th Anniv/SRS & Premium/TRD Off-Road & Pro/Trail Venture (Excl. Limited/Nightside/TRD Sport)	82"	29-23835
2008	2023	Toyota	Tacoma Double Cab	78"	29-22778
2022	2023	Toyota	Tundra Crew Max	—	29-24225
2022	2023	Toyota	Tundra Double Cab	74"	29-24225

FOOTNOTES: ¹ Excludes Chassis Cab With Diesel Exhaust Fluid (DEF) Tank Vehicles

RUNNING BOARDS

WESTIN®

SG6 LED RUNNING BOARDS

POLISHED ALUMINUM / BLACK ALUMINUM

- ▶ Vehicle specific mount kit required - sold separately
- ▶ Stylish modern design
- ▶ Protects vehicle rocker panels from potential damage
- ▶ 5 1/2" step surface width
- ▶ Corrosion resistant extruded aluminum board
- ▶ Injection molded end caps
- ▶ Slip resistant textured step surface
- ▶ Water-resistant LED lights illuminate step surface included
- ▶ Magnetic switches automatically turn on LED lights included
- ▶ Rocker panel gap strip included for finished look

FINISH: Polished
MATERIAL: Aluminum
WARRANTY: 5-Year
LED WARRANTY: Limited Lifetime

FINISH: Black
MATERIAL: Aluminum
WARRANTY: 5-Year
LED WARRANTY: Limited Lifetime

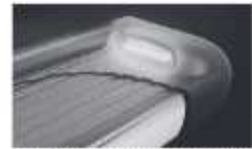

WATER-RESISTANT LED LIGHTS ILLUMINATES STEP SURFACE

START	END	MAKE	MODEL	LENGTH (IN.)	POLISHED	BLACK	REQUIRED MOUNT KIT
2003	2017	Buick	Enclave ¹	68"	27-66710	—	27-1835
2004	2012	Chevrolet	Colorado Crew Cab ¹	79"	27-66720	27-66725	27-1996
2015	2022	Chevrolet	Colorado Crew Cab (incl. Diesel) ¹	79"	27-66720	27-66725	27-2209
2015	2022	Chevrolet	Colorado Ext. Cab (incl. Diesel) ¹	68"	27-66710	—	27-2209
2007	2013	Chevrolet	Silverado 1500 Crew Cab (Excl. 2007 Classic) ¹	88"	27-66760	27-66765	27-1755
2014	2018	Chevrolet	Silverado 1500 Crew Cab ¹	88"	27-66760	27-66765	27-2145
2014	2018	Chevrolet	Silverado 1500 Double Cab ¹	75"	27-66720	27-66725	27-2145
2019	2023	Chevrolet	Silverado 1500 Double Cab (Excl. 2019 LD) ¹	75"	27-66720	27-66725	27-2285
2007	2013	Chevrolet	Silverado 1500 Ext. Cab (Excl. 2007 Classic) ¹	79"	27-66720	27-66725	27-1745
2007	2014	Chevrolet	Silverado 2500/3500HD Crew Cab (Excl. 2007 Classic)(incl. Diesel) ¹	88"	27-66760	27-66765	27-1755
2015	2019	Chevrolet	Silverado 2500/3500HD Crew Cab (Excl. Diesel) ¹	88"	27-66760	27-66765	27-2145
2015	2019	Chevrolet	Silverado 2500/3500HD Double Cab (Excl. Diesel)	75"	27-66720	27-66725	27-2145
2020	2023	Chevrolet	Silverado 2500/3500 Double Cab ¹	75"	27-66720	27-66725	27-2285
2007	2014	Chevrolet	Silverado 2500/3500HD Ext. Cab (Excl. 2007 Classic)(incl. Diesel) ¹	79"	27-66720	27-66725	27-1745
2019	2019	Chevrolet	Silverado LD Double Cab ¹	75"	27-66720	27-66725	27-2145
1995	1999	Chevrolet	Tahoe 2Dr ¹	68"	27-66710	—	27-1035
1995	1999	Chevrolet	Tahoe 4Dr ¹	79"	27-66720	27-66725	27-1036
2000	2004	Chevrolet	Tahoe 4Dr (Excl. 2002-2004 Z71) ¹	75"	27-66720	27-66725	27-1036
2005	2015	Chevrolet	Tahoe 4Dr (Excl. Hybrid & Z71) ¹	75"	27-66720	27-66725	27-1645
2002	2009	Chevrolet	Traillazer ¹	68"	27-66710	—	27-1836
2009	2017	Chevrolet	Traverse ¹	68"	27-66710	—	27-1836
2004	2010	Dodge	Durango ¹	78"	27-66720	27-66725	27-1545
2011	2017	Dodge	Durango ¹	75"	27-66720	27-66725	27-1975
1994	2001	Dodge	Ram 1500 3Dr & Quad Cab	79"	27-66720	27-66725	27-1108

CONTINUED ON NEXT PAGE →

SG6 LED RUNNING BOARDS CONTINUED

POLISHED ALUMINUM / BLACK ALUMINUM

START	END	MAKE	MODEL	LENGTH (IN.)	POLISHED	BLACK	REQUIRED MOUNT KIT
2009	2018	Dodge	Ram 1500 Crew Cab	65"	27-69760	27-69765	27-1905
2009	2018	Dodge	Ram 1500 Quad Cab	75"	27-69720	27-69725	27-1905
2010	2023	Dodge	Ram 2500/3500 Crew Cab ⁴	65"	27-69760	27-69765	27-1909
2021	2023	Ford	Bronco 4Dr (Excl. Bronco Sport)	75"	27-69720	27-69725	27-2425
1997	2014	Ford	Expedition	75"	27-69720	27-69725	27-1015
2007	2014	Ford	Expedition ^{1,2}	75"	27-69720	27-69725	27-1019
1995	2001	Ford	Explorer 4Dr (Excl. Sport)(Excl. 2002 Body Style) ^{1,2}	65"	27-69710	—	27-1115
2011	2019	Ford	Explorer ^{1,2}	65"	27-69710	—	27-1965
2004	2008	Ford	F-150 SuperCrew (Excl. 2004 Heritage) ¹	65"	27-69730	27-69735	27-1639
1997	2004	Ford	F-150/2500 SuperCab, 3 & 4Dr (2004 Heritage Only)	65"	27-69710	—	27-1265
2019	2023	Ford	Ranger SuperCab	65"	27-69710	—	27-2265
2007	2016	GMC	Acadia (Excl. Denali) ¹	65"	27-69710	—	27-1035
2004	2012	GMC	Canyon Crew Cab ¹	75"	27-69720	27-69725	27-1595
2015	2022	GMC	Canyon Crew Cab (Incl. Diesel) ¹	75"	27-69720	27-69725	27-2205
2015	2022	GMC	Canyon Ext Cab (Incl. Diesel) ¹	65"	27-69710	—	27-2205
2002	2010	GMC	Envoy (Excl. XUV)	65"	27-69710	—	27-1355
2007	2013	GMC	Sierra 1500 Crew Cab (Excl. 2007 Classic) ¹	65"	27-69730	27-69735	27-1755
2014	2018	GMC	Sierra 1500 Crew Cab ¹	65"	27-69730	27-69735	27-2145
2014	2018	GMC	Sierra 1500 Double Cab ¹	75"	27-69720	27-69725	27-2145
2019	2023	GMC	Sierra 1500 Double Cab (Excl. 2019 Limited) ¹	75"	27-69720	27-69725	27-2265
2007	2013	GMC	Sierra 1500 Ext Cab (Excl. 2007 Classic) ¹	75"	27-69720	27-69725	27-1745
2019	2019	GMC	Sierra 1500 Limited Double Cab ¹	75"	27-69720	27-69725	27-2145
2007	2014	GMC	Sierra 2500/3500HD Crew Cab (Excl. 2007 Classic)(Incl. Diesel) ¹	65"	27-69730	27-69735	27-1755
2015	2019	GMC	Sierra 2500/3500HD Crew Cab (Excl. Diesel) ¹	65"	27-69730	27-69735	27-2145
2015	2019	GMC	Sierra 2500/3500HD Double Cab (Excl. Diesel)	75"	27-69720	27-69725	27-2145
2020	2023	GMC	Sierra 2500/3500 Double Cab ¹	75"	27-69720	27-69725	27-2255
2007	2014	GMC	Sierra 2500/3500HD Ext Cab (Excl. 2007 Classic)(Incl. Diesel) ¹	75"	27-69720	27-69725	27-1745
1995	1999	GMC	Yukon 2Dr	65"	27-69710	—	27-1015
1995	1999	GMC	Yukon 4Dr	75"	27-69720	27-69725	27-1019
2000	2004	GMC	Yukon 4Dr (Excl. 2002-2004 Z71) ¹	75"	27-69720	27-69725	27-1035
2005	2013	GMC	Yukon 4Dr (Excl. Hybrid & Z71) ¹	75"	27-69720	27-69725	27-1645
2008	2014	Honda	Ridgeline ^{1,2}	65"	27-69760	27-69765	27-1775
2005	2010	Jeep	Commander ¹	65"	27-69710	—	27-1765
2005	2010	Jeep	Grand Cherokee ¹	65"	27-69710	—	27-1765
2011	2017	Jeep	Grand Cherokee (Excl. Diesel) ¹	65"	27-69710	—	27-1975
2005	2021	Nissan	Frontier Crew Cab ¹	75"	27-69720	27-69725	27-1639
2005	2021	Nissan	Frontier Ext King Cab ¹	65"	27-69710	—	27-1639
2022	2023	Nissan	Frontier King Cab	65"	27-69710	—	27-2435
2005	2012	Nissan	Pathfinder ¹	65"	27-69710	—	27-1639
2004	2016	Nissan	Titan Ext King Cab ¹	65"	27-69710	—	27-1665
2019	2023	Ram	1500 Classic Crew Cab	65"	27-69760	27-69765	27-1909
2019	2023	Ram	1500 Classic Quad Cab	75"	27-69720	27-69725	27-1905
2009	2018	Ram	1500 Crew Cab	65"	27-69760	27-69765	27-1905
2019	2023	Ram	1500 Crew Cab (Excl. Classic)	65"	27-69730	27-69735	27-2245
2009	2018	Ram	1500 Quad Cab	75"	27-69720	27-69725	27-1909
2010	2023	Ram	2500/3500 Crew Cab ^{1,4}	65"	27-69760	27-69765	27-1905
2003	2009	Toyota	4Runner (Base Model) ¹	65"	27-69710	—	27-1505
2006	2009	Toyota	4Runner ¹	65"	27-69710	—	27-1505
2010	2023	Toyota	4Runner Limited Nightshade TRD Sport (Excl. 40th Anni SR5 & Premium TRD Off-Road & Pro Trail Venture) ⁴	65"	27-69710	—	27-1945
2014	2023	Toyota	4Runner 40th Anni SR5 & Premium TRD Off-Road & Pro Trail Venture (Excl. Limited Nightshade TRD Sport) ⁴	65"	27-69710	—	27-2165
2010	2013	Toyota	4Runner SR5 (Excl. Trail) ¹	65"	27-69710	—	27-1945
2010	2017	Toyota	4Runner Trail (Excl. Limited) ¹	65"	27-69710	—	27-2165
2001	2007	Toyota	Highlander (Excl. Hybrid) ^{1,2}	65"	27-69710	—	27-1365
2008	2019	Toyota	Highlander ¹	65"	27-69710	—	27-1655
1999	2004	Toyota	Tacoma Access Cab	65"	27-69710	—	27-1005
2005	2023	Toyota	Tacoma Access Cab ¹	65"	27-69710	—	27-1615
1999	2006	Toyota	Tundra Access Cab	65"	27-69710	—	27-1155

FOOTNOTES: 1. Not Compatible With OEM Skirt Cladding. 2. Requires Board To Be Shortened. 3. Models With Mud Flaps, Use 68 Inch Boards (27-5710/5715). 4. No Drilling Required. 5. Excludes Vehicles With Mud Flaps. 7. Not Compatible On Vehicles With Power Retracting Boards If Equipped. 8. Not Compatible With Optional Light Kit Part # 27-60000. 10. Excludes Chassis Cab With Diesel Exhaust Fluid (DEF) Tank Vehicles. 19. Requires Drilling.

SG6 RUNNING BOARDS

POLISHED ALUMINUM / BLACK ALUMINUM

- › Vehicle specific mount kit required - sold separately
- › Stylish modern design
- › Protects vehicle rocker panels from potential damage
- › 5 1/2" step surface width
- › Corrosion resistant extruded aluminum board
- › Injection molded end caps
- › Slip resistant textured step surface
- › Rocker panel gap strip included for finished look
- › Optional light kit for end caps (part no. 27-60000)

FINISH: Polished
MATERIAL: Aluminum
WARRANTY: 5 Year

FINISH: Black
MATERIAL: Aluminum
WARRANTY: 5-Year

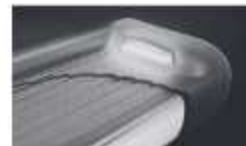

OPTIONAL LED LIGHT KIT
 PN# 27-80000

START	END	MAKE	MODEL	LENGTH (IN.)	POLISHED	BLACK	REQUIRED MOUNT KIT
2009	2017	Buick	Enclave ¹	68"	27-64710	27-64715	27-1039
2009	2019	Chevrolet	Avalanche (W/D Cladding)	90"	27-64740	27-64745	27-1045
1992	2009	Chevrolet	C/K 1500/2500/3500 Crew Cab (Excl. 1999-2001 Silverado 1500/2500) ¹	90"	27-64740	27-64745	27-1045
1999	1999	Chevrolet	C/K 1500/2500/3500 Ext Cab	79"	27-64730	27-64735	27-1056
2004	2012	Chevrolet	Colorado Crew Cab ¹	75"	27-64720	27-64725	27-1099
2016	2022	Chevrolet	Colorado Crew Cab (Incl. Diesel) ¹	75"	27-64720	27-64725	27-2259
2016	2022	Chevrolet	Colorado Ext Cab (Incl. Diesel) ¹	68"	27-64710	27-64715	27-2209
2001	2007	Chevrolet	Silverado "Classic" 1500/2500/3500HD Crew Cab	90"	27-64740	27-64745	27-1095
1999	2007	Chevrolet	Silverado "Classic" 1500/2500LD Ext Cab	79"	27-64730	27-64735	27-1026
2001	2007	Chevrolet	Silverado "Classic" 2500/3500HD Ext Cab	79"	27-64730	27-64735	27-1026
2007	2013	Chevrolet	Silverado 1500 Crew Cab (Excl. 2007 Classic) ¹	86"	27-64750	27-64755	27-1755
2014	2016	Chevrolet	Silverado 1500 Crew Cab ¹	86"	27-64750	27-64755	27-2145
2019	2023	Chevrolet	Silverado 1500 Crew Cab	90"	27-64740	27-64745	27-2259
2014	2016	Chevrolet	Silverado 1500 Double Cab ¹	79"	27-64720	27-64725	27-2149
2019	2023	Chevrolet	Silverado 1500 Double Cab (Excl. LD) ¹	75"	27-64720	27-64725	27-2259
2007	2013	Chevrolet	Silverado 1500 Ext Cab (Excl. 2007 Classic) ¹	75"	27-64720	27-64725	27-1745
2007	2014	Chevrolet	Silverado 2500/3500HD Crew Cab (Excl. 2007 Classic)(Incl. Diesel) ¹	86"	27-64750	27-64755	27-1755
2015	2019	Chevrolet	Silverado 2500/3500HD Crew Cab (Excl. Diesel) ¹	86"	27-64750	27-64755	27-2149
2020	2023	Chevrolet	Silverado 2500/3500 Crew Cab	90"	27-64740	27-64745	27-2259
2015	2019	Chevrolet	Silverado 2500/3500HD Double Cab (Excl. Diesel)	75"	27-64720	27-64725	27-2145
2020	2023	Chevrolet	Silverado 2500/3500 Double Cab ¹	75"	27-64720	27-64725	27-2259
2007	2014	Chevrolet	Silverado 2500/3500HD Ext Cab (Excl. 2007 Classic)(Incl. Diesel) ¹	75"	27-64720	27-64725	27-1745
2019	2019	Chevrolet	Silverado LD Double Cab ¹	75"	27-64720	27-64725	27-2145
1992	1999	Chevrolet	Suburban	90"	27-64740	27-64745	27-1045

CONTINUED ON NEXT PAGE

SG6 RUNNING BOARDS CONTINUED

POLISHED ALUMINUM / BLACK ALUMINUM

START	END	MAKE	MODEL	LENGTH (IN.)	POLISHED	BLACK	REQUIRED MOUNT KIT
2000	2004	Chevrolet	Suburban (Excl. 2002-2004 Z71)	90"	27-64740	27-64745	27-1033
2008	2010	Chevrolet	Suburban (Excl. Hybrid & Z71) *	90"	27-64740	27-64745	27-1845
1995	1999	Chevrolet	Tahoe 2Dr	85"	27-64710	27-64715	27-1015
1995	1999	Chevrolet	Tahoe 4Dr	75"	27-64720	27-64725	27-1015
2000	2004	Chevrolet	Tahoe 4Dr (Excl. 2002-2004 Z71)	75"	27-64720	27-64725	27-1033
2005	2010	Chevrolet	Tahoe 4Dr (Excl. Hybrid & Z71) *	75"	27-64720	27-64725	27-1845
2002	2009	Chevrolet	TrailBlazer	65"	27-64710	27-64715	27-1359
2009	2017	Chevrolet	Traverse *	65"	27-64710	27-64715	27-1035
2016	2022	Chevrolet	Traverse *	75"	27-64730	27-64735	27-2275
2004	2010	Dodge	Durango *	75"	27-64720	27-64725	27-1845
2011	2017	Dodge	Durango *	75"	27-64720	27-64725	27-1975
1994	2001	Dodge	Ram 1500 3Dr & Quad Cab	75"	27-64720	27-64725	27-1185
2009	2018	Dodge	Ram 1500 Crew Cab	85"	27-64760	27-64765	27-1905
2002	2008	Dodge	Ram 1500 Quad Cab *	75"	27-64730	27-64735	27-1375
2009	2018	Dodge	Ram 1500 Quad Cab	75"	27-64720	27-64725	27-1905
1994	2002	Dodge	Ram 2500/3500 3Dr & Quad Cab	75"	27-64730	27-64735	27-1185
2010	2023	Dodge	Ram 2500/3500 Crew Cab *	85"	27-64760	27-64765	27-1905
2003	2009	Dodge	Ram 2500/3500 Quad Cab (Excl. Daytona, Rumble Bee, & BRT-10)	75"	27-64730	27-64735	27-1375
2008	2009	Dodge	Ram 4500/5500 Quad Cab	75"	27-64730	27-64735	27-1375
2021	2023	Ford	Bronco 4Dr (Excl. Bronco Sport)	75"	27-64720	27-64725	27-2425
1999	2005	Ford	Excursion *	90"	27-64740	27-64745	27-1215
1997	2014	Ford	Expedition	75"	27-64720	27-64725	27-1815
2007	2014	Ford	Expedition *	75"	27-64720	27-64725	27-1815
2007	2014	Ford	Expedition EL **	90"	27-64740	27-64745	27-1815
1995	2001	Ford	Explorer 4Dr (Excl. Sport) (Excl. 2002 Body Style) **	65"	27-64710	27-64715	27-1115
2002	2005	Ford	Explorer 4Dr (Excl. Sport)	75"	27-64730	27-64735	27-1345
2005	2010	Ford	Explorer 4Dr (Excl. Sport) *	75"	27-64730	27-64735	27-1675
2011	2019	Ford	Explorer *	85"	27-64720	27-64725	27-1955
2020	2023	Ford	Explorer *	75"	27-64730	27-64735	27-2285
2007	2010	Ford	Explorer Sport Trac *	75"	27-64730	27-64735	27-1795
2004	2014	Ford	F-150 SuperCab (Excl. 2004 Heritage) *	75"	27-64730	27-64735	27-1525
2015	2023	Ford	F-150 SuperCab	75"	27-64730	27-64735	27-2175
2001	2003	Ford	F-150 SuperCrew	75"	27-64730	27-64735	27-1255
2004	2005	Ford	F-150 SuperCrew (Excl. 2004 Heritage) *	85"	27-64750	27-64755	27-1835
2009	2014	Ford	F-150 SuperCrew *	90"	27-64740	27-64745	27-1835
2015	2023	Ford	F-150 SuperCrew	90"	27-64740	27-64745	27-2195
1997	2004	Ford	F-150 250LD SuperCab, 3 & 4Dr (2004 Heritage Only)	65"	27-64710	27-64715	27-1255
1999	2018	Ford	F-250/350 Crew Cab *	90"	27-64740	27-64745	27-1215
2017	2023	Ford	F-250/350 Crew Cab	90"	27-64740	27-64745	27-2195
1999	2016	Ford	F-250/350 SuperCab	75"	27-64730	27-64735	27-1205
2017	2023	Ford	F-250/350 SuperCab	75"	27-64730	27-64735	27-2175
2019	2023	Ford	Ranger SuperCab	65"	27-64710	27-64715	27-2265
2019	2023	Ford	Ranger SuperCrew	75"	27-64730	27-64735	27-2265
2007	2016	GMC	Acadia (Excl. Denali) *	65"	27-64710	27-64715	27-1035
2004	2012	GMC	Canyon Crew Cab *	75"	27-64720	27-64725	27-1595
2015	2023	GMC	Canyon Crew Cab (Incl. Diesel) *	75"	27-64720	27-64725	27-2295
2015	2022	GMC	Canyon Ext Cab (Incl. Diesel) *	65"	27-64710	27-64715	27-2295
2002	2010	GMC	Envoy (Excl. XUV)	65"	27-64710	27-64715	27-1055
1999	2007	GMC	Sierra "Classic" 1500/2500LD Ext Cab	75"	27-64730	27-64735	27-1025
2001	2007	GMC	Sierra "Classic" 2500/3500HD Ext Cab	75"	27-64730	27-64735	27-1025
2007	2013	GMC	Sierra 1500 Crew Cab (Excl. 2007 Classic) *	85"	27-64750	27-64755	27-1735
2014	2018	GMC	Sierra 1500 Crew Cab *	85"	27-64750	27-64755	27-2145
2019	2023	GMC	Sierra 1500 Crew Cab (Excl. 2019 Limited)	90"	27-64740	27-64745	27-2235
2014	2018	GMC	Sierra 1500 Double Cab *	75"	27-64720	27-64725	27-2145
2019	2023	GMC	Sierra 1500 Double Cab (Excl. 2019 Limited) *	75"	27-64720	27-64725	27-2235
2007	2019	GMC	Sierra 1500 Ext Cab (Excl. 2007 Classic) *	75"	27-64720	27-64725	27-1745
2019	2019	GMC	Sierra 1500 Limited Double Cab *	75"	27-64720	27-64725	27-2145
2007	2014	GMC	Sierra 2500/3500HD Crew Cab (Excl. 2007 Classic) (Incl. Diesel) *	85"	27-64750	27-64755	27-1755
2015	2019	GMC	Sierra 2500/3500HD Crew Cab (Excl. Diesel) *	85"	27-64750	27-64755	27-2145
2020	2023	GMC	Sierra 2500/3500 Crew Cab	90"	27-64740	27-64745	27-2255
2015	2019	GMC	Sierra 2500/3500HD Double Cab (Excl. Diesel)	75"	27-64720	27-64725	27-2145
2020	2023	GMC	Sierra 2500/3500 Double Cab *	75"	27-64720	27-64725	27-2285
2007	2014	GMC	Sierra 2500/3500HD Ext Cab (Excl. 2007 Classic) (Incl. Diesel) *	75"	27-64720	27-64725	27-1745
1995	1999	GMC	Yukon 2Dr	65"	27-64710	27-64715	27-1015
1995	1999	GMC	Yukon 4Dr	75"	27-64720	27-64725	27-1015
2000	2004	GMC	Yukon 4Dr (Excl. 2002-2004 Z71) *	75"	27-64720	27-64725	27-1035
2005	2014	GMC	Yukon 4Dr (Excl. Hybrid & Z71) (Excl. 2007 Classic) *	75"	27-64720	27-64725	27-1645
2000	2004	GMC	Yukon XL (Excl. 2002-2004 Z71)	90"	27-64740	27-64745	27-1035
2005	2013	GMC	Yukon XL (Excl. Hybrid & Z71) *	90"	27-64740	27-64745	27-1645
2005	2014	Honda	Ridgeline **	85"	27-64750	27-64755	27-1775
2005	2008	Isuzu	i-Series Crew Cab	75"	27-64730	27-64735	27-1595
2005	2010	Jeep	Commander *	65"	27-64710	27-64715	27-1785
2005	2010	Jeep	Grand Cherokee *	65"	27-64710	27-64715	27-1785
2011	2017	Jeep	Grand Cherokee (Excl. Diesel) **	65"	27-64710	27-64715	27-1975
2002	2005	Mercury	Mountaineer	75"	27-64730	27-64735	27-1345
2005	2010	Mercury	Mountaineer **	75"	27-64730	27-64735	27-1675
2004	2015	Nissan	Armada	75"	27-64730	27-64735	27-1565
2005	2021	Nissan	Frontier Crew Cab *	75"	27-64720	27-64725	27-1635
2022	2023	Nissan	Frontier Crew Cab	75"	27-64730	27-64735	27-2435
2005	2021	Nissan	Frontier Ext King Cab *	65"	27-64710	27-64715	27-1635
2022	2023	Nissan	Frontier King Cab	65"	27-64710	27-64715	27-2435
2005	2012	Nissan	Pathfinder *	65"	27-64710	27-64715	27-1635

CONTINUED ON NEXT PAGE →

SG6 RUNNING BOARDS CONTINUED

POLISHED ALUMINUM / BLACK ALUMINUM

START	END	MAKE	MODEL	LENGTH (IN.)	POLISHED	BLACK	REQUIRED MOUNT KIT
2004	2016	Nissan	Titan Crew Cab ¹	79"	27-64730	27-64735	27-1565
2004	2016	Nissan	Titan Extending Cab ¹	88"	27-64710	27-64716	27-1565
2019	2023	Ram	1500 Classic Crew Cab	83"	27-64760	27-64765	27-1905
2019	2023	Ram	1500 Classic Quad Cab	75"	27-64720	27-64725	27-1905
2009	2016	Ram	1500 Crew Cab	80"	27-64760	27-64765	27-1905
2019	2023	Ram	1500 Crew Cab (Excl. Classic)	86"	27-64750	27-64755	27-2245
2009	2016	Ram	1500 Quad Cab	75"	27-64720	27-64725	27-1905
2019	2023	Ram	1500 Quad Cab (Excl. Classic)	79"	27-64730	27-64735	27-2245
2010	2023	Ram	2500/3500 Crew Cab ¹	80"	27-64760	27-64765	27-1905
2003	2009	Toyota	4Runner (Base Model) ¹	68"	27-64710	27-64716	27-1945
2006	2009	Toyota	4Runner ¹	68"	27-64710	27-64716	27-1945
2010	2023	Toyota	4Runner Limited/Nightshade TRD Sport (Excl. 40th Anniversary & Premium TRD Off-Road & Pro/Trek/Venture) ¹	68"	27-64710	27-64716	27-1945
2014	2023	Toyota	4Runner 40th Anniversary SRS & Premium TRD Off-Road & Pro/Trek/Venture (Excl. Limited/Nightshade TRD Sport) ¹	68"	27-64710	27-64716	27-2165
2010	2013	Toyota	4Runner SRS (Excl. Trek) ¹	68"	27-64710	27-64716	27-1945
2010	2017	Toyota	4Runner Trek (Excl. Limited) ¹	68"	27-64710	27-64716	27-2165
2001	2007	Toyota	Highlander (Excl. Hybrid) ^{1,2}	68"	27-64710	27-64716	27-1365
2008	2013	Toyota	Highlander ¹	68"	27-64710	27-64716	27-1855
2001	2007	Toyota	Sequoia ¹	79"	27-64730	27-64735	27-1325
2008	2022	Toyota	Sequoia	79"	27-64730	27-64735	27-1875
1999	2004	Toyota	Tacoma Access Cab	68"	27-64710	27-64716	27-1085
2006	2023	Toyota	Tacoma Access Cab ¹	68"	27-64710	27-64716	27-1615
2001	2004	Toyota	Tacoma Double Cab ¹	79"	27-64730	27-64735	27-1605
2006	2023	Toyota	Tacoma Double Cab ^{1,3}	79"	27-64730	27-64735	27-1615
1999	2008	Toyota	Tundra Access Cab	68"	27-64710	27-64716	27-1155
2007	2021	Toyota	Tundra Crew Max ¹	90"	27-64740	27-64745	27-1725
2022	2023	Toyota	Tundra Crew Max ¹	90"	27-64740	27-64745	27-2485
2004	2006	Toyota	Tundra Double Cab	79"	27-64730	27-64735	27-1325
2007	2021	Toyota	Tundra Double Cab ¹	79"	27-64730	27-64735	27-1725
2022	2023	Toyota	Tundra Double Cab ¹	79"	27-64730	27-64735	27-2485

FOOTNOTES: 1. Not Compatible With OEM Skirt Cladding. 2. Requires Board To Be Shortened. 3. Models With Mud Flaps, Use 68 Inch Boards (27-6710/6716). 4. No Drilling Required. 5. Excludes Vehicles With Mud Flaps. 6. Not Compatible On Vehicles With Power Retracting Boards If Equipped. 7. Not Compatible With Optional Light Kit Part# 27-60000. 8. Excludes Chassis Cab With Diesel Exhaust Fluid (DEF) Tank Vehicles. 9. Requires Drilling.



WESTIN[®] | RUNNING BOARDS

GRATE STEPS RUNNING BOARDS TEXTURED BLACK

- ▶ Vehicle specific mount kit required - sold separately
- ▶ Available in universal lengths (54", 66", 75", 79", 83", 86" and 90")
- ▶ Protects vehicle rocker panels from potential damage
- ▶ Solid 1-piece construction for added strength
- ▶ Engineered to provide maximum traction without sacrificing style
- ▶ Serrated edges help clean dirt, snow and mud off your boots to keep truck cab clean
- ▶ Aggressive 1/4" high punched tread allows for traction in any weather condition
- ▶ E-coated base coat provides long lasting corrosion protection
- ▶ 6 1/4" step surface width
- ▶ Custom die-cast riveted logo badge
- ▶ Ends are stylishly formed and fully welded
- ▶ Ideal for construction and commercial use
- ▶ Available in textured black finish

FINISH: Textured Black Powder Coat

MATERIAL: E-Coated Steel

WARRANTY: 3-Year



START	END	MAKE	MODEL	LENGTH (IN.)	TEXTURED BLACK	REQUIRED MOUNT KIT
2003	2017	Buick	Enclave ¹	66"	27-74715	27-1025
2006	2019	Chevrolet	Avalanche (W/O Cladding)	90"	27-74745	27-1649
1992	2000	Chevrolet	C/K Series Crew Cab 5' (Excl. 1999-2000 New Body Style)	90"	27-74745	27-1045
1998	1999	Chevrolet	C/K Series Ext. Cab	79"	27-74725	27-1005
2004	2012	Chevrolet	Colorado Crew Cab ¹	75"	27-74725	27-1599
2015	2022	Chevrolet	Colorado Crew Cab (Incl. Diesel) ¹	75"	27-74725	27-2209
2015	2022	Chevrolet	Colorado Ext. Cab (Incl. Diesel) ¹	61"	27-74715	27-2209
2003	2023	Chevrolet	Express W/ 135" Wheel Base (45" Driver Side & 37" Passenger Side)	46" & 57"	27-81005	27-2325
2003	2023	Chevrolet	Express W/ 155" Wheel Base (45" Driver Side & 37" Passenger Side)	46" & 57"	27-81005	27-2325
2003	2023	Chevrolet	Express W/ 135" Wheel Base (For Single 54" Passenger Sliding Door)	54"	27-81015	27-2345
2003	2023	Chevrolet	Express (For Single 54" Rear Door)	54"	27-81015	27-2345
2001	2007	Chevrolet	Silverado "Classic" 1500/2500/3500HD Crew Cab	90"	27-74745	27-1205
1999	2007	Chevrolet	Silverado "Classic" 1500/2500LD Ext. Cab	79"	27-74725	27-1025
1999	2007	Chevrolet	Silverado "Classic" 1500/2500LD Reg. Cab	54"	27-81015	27-1455
2001	2007	Chevrolet	Silverado "Classic" 2500/3500HD Ext. Cab	79"	27-74725	27-1025
2001	2007	Chevrolet	Silverado "Classic" 2500/3500HD Reg. Cab	54"	27-81015	27-1455
2007	2013	Chevrolet	Silverado 1500 Crew Cab (Excl. Classic) ¹	86"	27-74755	27-1745
2014	2018	Chevrolet	Silverado 1500 Crew Cab ¹	86"	27-74755	27-2145
2019	2023	Chevrolet	Silverado 1500 Crew Cab	90"	27-74745	27-2255
2014	2018	Chevrolet	Silverado 1500 Double Cab ¹	75"	27-74725	27-2145
2019	2023	Chevrolet	Silverado 1500 Double Cab (Excl. 2019 LD) ¹	75"	27-74725	27-2255
2007	2013	Chevrolet	Silverado 1500 Ext. Cab (Excl. Classic) ¹	75"	27-74725	27-1745
2007	2013	Chevrolet	Silverado 1500 Reg. Cab (Excl. Classic) ¹	54"	27-74705	27-1735
2014	2019	Chevrolet	Silverado 1500 Reg. Cab ¹	54"	27-74705	27-2135
2020	2023	Chevrolet	Silverado 2500/3500 Crew Cab	90"	27-74745	27-2255
2020	2023	Chevrolet	Silverado 2500/3500 Double Cab ¹	75"	27-74725	27-2255
2007	2014	Chevrolet	Silverado 2500/3500 Reg. Cab (Excl. Classic)(Incl. Diesel) ¹	54"	27-74705	27-1735

CONTINUED ON NEXT PAGE →

GRATE STEPS RUNNING BOARDS CONTINUED

TEXTURED BLACK

START	END	MAKE	MODEL	LENGTH (IN.)	TEXTURED BLACK	REQUIRED MOUNT KIT
2007	2014	Chevrolet	Silverado 2500/3500HD Crew Cab (Excl. Classic/Incl. Diesel) †	88"	27-74755	27-1795
2016	2019	Chevrolet	Silverado 2500/3500HD Crew Cab (Excl. Diesel) †	88"	27-74755	27-2145
2016	2019	Chevrolet	Silverado 2500/3500HD Double Cab (Excl. Diesel) †	75"	27-74725	27-2145
2007	2014	Chevrolet	Silverado 2500/3500HD Ext Cab (Excl. Classic/Incl. Diesel) †	75"	27-74725	27-1745
2016	2019	Chevrolet	Silverado 2500/3500HD Reg Cab (Excl. Diesel) †	64"	27-74705	27-2135
2019	2019	Chevrolet	Silverado LD Double Cab †	75"	27-74725	27-2145
1992	1999	Chevrolet	Suburban	90"	27-74745	27-1045
2000	2004	Chevrolet	Suburban (Excl. 2002-2004 Z71)	90"	27-74745	27-1035
2006	2010	Chevrolet	Suburban (Excl. Hybrid & Z71) †	90"	27-74745	27-1645
2000	2004	Chevrolet	Tahoe 4Dr (Excl. 2002-2004 Z71)	75"	27-74725	27-1035
2006	2010	Chevrolet	Tahoe 4Dr (Excl. Hybrid & Z71) †	75"	27-74725	27-1645
2002	2009	Chevrolet	Trailblazer	65"	27-74715	27-1355
2016	2022	Chevrolet	Traverse †	79"	27-74735	27-2075
2009	2017	Chevrolet	Traverse †	68"	27-74715	27-1835
2004	2010	Dodge	Durango †	75"	27-74725	27-1545
2011	2017	Dodge	Durango †	75"	27-74725	27-1975
1994	2001	Dodge	Ram 1500 3Dr & Quad Cab	78"	27-74725	27-1185
2009	2018	Dodge	Ram 1500 Crew Cab	83"	27-74765	27-1905
2002	2008	Dodge	Ram 1500 Quad Cab (Excl. Daytona, Rumble Bee, & SRT-10)	79"	27-74735	27-1375
2009	2018	Dodge	Ram 1500 Quad Cab	75"	27-74725	27-1905
2009	2018	Dodge	Ram 1500 Reg Cab	64"	27-74705	27-1895
1994	2002	Dodge	Ram 2500/3500 3Dr & Quad Cab	79"	27-74735	27-1185
2010	2023	Dodge	Ram 2500/3500 Crew Cab †	83"	27-74765	27-1905
2003	2009	Dodge	Ram 2500/3500 Quad Cab (Excl. Daytona, Rumble Bee, & SRT-10)	79"	27-74735	27-1375
2010	2023	Dodge	Ram 2500/3500 Reg Cab †	64"	27-74705	27-1895
2003	2009	Dodge	Ram 4500/5500 Quad Cab	79"	27-74735	27-1375
2007	2023	Ford	Bronco 2Dr (Excl. Bronco Sport)	54"	27-74705	27-2425
2021	2023	Ford	Bronco 4Dr (Excl. Bronco Sport)	75"	27-74725	27-2425
1999	2008	Ford	Excursion †	90"	27-74745	27-1215
1997	2014	Ford	Expedition	75"	27-74725	27-1815
2007	2014	Ford	Expedition †	75"	27-74725	27-1815
2007	2014	Ford	Expedition EL †	90"	27-74745	27-1815
1996	2001	Ford	Explorer 4Dr (Excl. Sport)(Excl. 2002 Body Style) †	68"	27-74715	27-1115
2002	2008	Ford	Explorer 4Dr (Excl. Sport)	79"	27-74735	27-1345
2006	2010	Ford	Explorer †	79"	27-74735	27-1675
2011	2019	Ford	Explorer	65"	27-74715	27-1945
2020	2023	Ford	Explorer	79"	27-74735	27-2285
2007	2010	Ford	Explorer Sport Trac †	79"	27-74735	27-1795
2016	2023	Ford	F-150 Reg Cab	64"	27-74705	27-2175
2004	2014	Ford	F-150 SuperCab (Excl. 2004 Heritage) †	79"	27-74735	27-1925
2016	2023	Ford	F-150 SuperCab	79"	27-74735	27-2175
2004	2008	Ford	F-150 SuperCrew (Excl. 2004 Heritage) †	88"	27-74755	27-1535
2009	2014	Ford	F-150 SuperCrew †	90"	27-74745	27-1885
2016	2023	Ford	F-150 SuperCrew	90"	27-74745	27-2195
2017	2023	Ford	F-250/350 Crew Cab	90"	27-74745	27-2195
2017	2023	Ford	F-250/350 Reg Cab	64"	27-74705	27-2175
1999	2016	Ford	F-250/350 Super Duty Crew Cab †	90"	27-74745	27-1205
1999	2016	Ford	F-250/350 Super Duty SuperCab	79"	27-74735	27-1205
2017	2023	Ford	F-250/350 SuperCab	79"	27-74735	27-2175
2019	2021	Ford	Ranger SuperCab	65"	27-74715	27-2265
2019	2021	Ford	Ranger SuperCrew	79"	27-74735	27-2265
2015	2023	Ford	Transit Van 150 250/350 (48" Driver side & 37" Passenger side) †	48" & 97"	27-81005	Included
2016	2023	Ford	Transit Van 150 250/350 (48" Driver side & 37" Passenger side) †	48" & 97"	27-81005	27-2295
2015	2023	Ford	Transit Van 150 250/350 (Single 54" Passenger Sliding Door) †	54"	27-81015	Included
2016	2023	Ford	Transit Van 150 250/350 (Single 54" Passenger Sliding Door) †	64"	27-81015	27-2305
2016	2023	Ford	Transit Van 150 250/350 (Single 54" Rear Door) †	54"	27-81015	27-2315
2007	2016	GMC	Acadia (Excl. Denali) †	68"	27-74715	27-1835
2004	2012	GMC	Canyon Crew Cab †	75"	27-74725	27-1595
2016	2022	GMC	Canyon Crew Cab (Incl. Diesel) †	75"	27-74725	27-2205
2016	2022	GMC	Canyon Ext Cab 4 (Incl. Diesel) †	68"	27-74715	27-2205
2002	2010	GMC	Envoy (Excl. XUV)	68"	27-74715	27-1365
2003	2023	GMC	Savana W/ 135" Wheel Base (48" Driver Side & 37" Passenger Side)	48" & 97"	27-81005	27-2325
2003	2023	GMC	Savana W/ 158" Wheel Base (48" Driver Side & 37" Passenger Side)	48" & 97"	27-81005	27-2335
2003	2023	GMC	Savana W/ 135" Wheel Base (For Single 54" Passenger Sliding Door)	64"	27-81015	27-2345
2000	2023	GMC	Savana (For Single 54" Rear Door)	54"	27-81015	27-2355
1999	2007	GMC	Sierra Classic® 1500/2500LD Ext Cab	79"	27-74735	27-1025
1999	2007	GMC	Sierra Classic® 1500/2500LD Reg Cab	64"	27-81015	27-1435
2001	2007	GMC	Sierra Classic® 2500/3500HD Ext Cab	79"	27-74735	27-1025
2001	2007	GMC	Sierra Classic® 2500/3500HD Reg Cab	64"	27-81015	27-1435
2007	2013	GMC	Sierra 1500 Crew Cab (Excl. Classic) †	65"	27-74755	27-1755
2014	2018	GMC	Sierra 1500 Crew Cab †	88"	27-74755	27-2145
2019	2023	GMC	Sierra 1500 Crew Cab	90"	27-74745	27-2255
2014	2018	GMC	Sierra 1500 Double Cab †	75"	27-74725	27-2145
2019	2023	GMC	Sierra 1500 Double Cab (Excl. 2019 Limited) †	75"	27-74725	27-2145
2007	2019	GMC	Sierra 1500 Ext Cab (Excl. Classic) †	75"	27-74725	27-1745
2019	2019	GMC	Sierra 1500 Limited Double Cab †	75"	27-74725	27-2145
2007	2019	GMC	Sierra 1500 Reg Cab (Excl. Classic) †	64"	27-74705	27-1735
2014	2018	GMC	Sierra 1500 Reg Cab †	64"	27-74705	27-2135
2020	2023	GMC	Sierra 2500/3500 Crew Cab	90"	27-74745	27-2255
2007	2014	GMC	Sierra 2500/3500 Reg Cab (Excl. Classic)(Incl. Diesel) †	64"	27-74705	27-1735
2007	2014	GMC	Sierra 2500/3500HD Crew Cab (Excl. Classic)(Incl. Diesel) †	88"	27-74755	27-1755
2016	2019	GMC	Sierra 2500/3500HD Crew Cab (Excl. Diesel) †	88"	27-74755	27-2145

CONTINUED ON NEXT PAGE →

GRATE STEPS RUNNING BOARDS CONTINUED TEXTURED BLACK

START	END	MAKE	MODEL	LENGTH (IN.)	TEXTURED BLACK	REQUIRED MOUNT KIT
2015	2019	GMC	Sierra 2500/3500HD Double Cab (Excl. Diesel)	75"	27-74725	27-2145
2007	2014	GMC	Sierra 2500/3500HD Ext Cab (Excl. Classic/Intl. Diesel) 1	75"	27-74725	27-1745
2015	2019	GMC	Sierra 2500/3500HD Reg Cab (Excl. Diesel) 4	54"	27-74705	27-2155
2000	2004	GMC	Yukon 4Dr (Excl. 2000-2004 Z71) 5	75"	27-74725	27-1035
2005	2013	GMC	Yukon 4Dr (Excl. Hybrid & Z71) 1	75"	27-74725	27-1645
2000	2004	GMC	Yukon XL (Excl. 2000-2004 Z71)	90"	27-74745	27-1035
2005	2013	GMC	Yukon XL (Excl. Hybrid & Z71) 1	90"	27-74745	27-1645
2006	2014	Honda	Ridgeline 2/4	85"	27-74765	27-1775
2006	2008	Isuzu	i-Series Crew Cab	79"	27-74735	27-1595
2008	2010	Jeep	Commander 7	68"	27-74715	27-1785
2005	2010	Jeep	Grand Cherokee 8	68"	27-74715	27-1785
2011	2017	Jeep	Grand Cherokee (Excl. Diesel) 7	68"	27-74715	27-1785
2007	2009	Mercedes-Benz	Sprinter (For Single 54" Passenger Sliding Door)	54"	27-80015	27-2455
2007	2009	Mercedes-Benz	Sprinter (For Single 54" Rear Door)	54"	27-80015	27-2465
2007	2009	Mercedes-Benz	Sprinter (For 48" Drivers Side And 97" Passenger Side)	48" & 97"	27-81005	27-2445
2002	2008	Mercury	Mountaineer	79"	27-74735	27-1345
2005	2010	Mercury	Mountaineer 11	79"	27-74735	27-1675
2004	2015	Nissan	Armada	79"	27-74735	27-1865
2005	2021	Nissan	Frontier Crew Cab 1	75"	27-74725	27-1635
2022	2025	Nissan	Frontier Crew Cab	79"	27-74735	27-2435
2005	2021	Nissan	Frontier Ext King Cab 1	68"	27-74715	27-1635
2022	2025	Nissan	Frontier King Cab	68"	27-74715	27-2435
2005	2012	Nissan	Pathfinder 1	68"	27-74715	27-1635
2004	2015	Nissan	Titan Crew Cab 11	79"	27-74735	27-1665
2004	2015	Nissan	Titan Ext King Cab 1	68"	27-74715	27-1665
2019	2023	Ram	1500 Classic Crew Cab	85"	27-74765	27-1905
2019	2023	Ram	1500 Classic Quad Cab	75"	27-74725	27-1905
2019	2023	Ram	1500 Classic Reg Cab	54"	27-74705	27-1895
2009	2018	Ram	1500 Crew Cab	85"	27-74765	27-1905
2019	2023	Ram	1500 Crew Cab (Excl. Classic)	86"	27-74765	27-2045
2009	2018	Ram	1500 Quad Cab	75"	27-74725	27-1905
2019	2023	Ram	1500 Quad Cab (Excl. Classic)	76"	27-74725	27-2045
2009	2018	Ram	1500 Reg Cab	54"	27-74705	27-1895
2010	2023	Ram	2500/3500 Crew Cab 16	85"	27-74765	27-1905
2010	2023	Ram	2500/3500 Reg Cab 16	54"	27-74705	27-1895
2014	2023	Ram	ProMaster 1500/2500/3500 W/ 135" Wheel Base (48" Driver Side & 97" Passenger Side)	48" & 97"	27-80075	27-2365
2014	2023	Ram	ProMaster 1500/2500/3500 W/ 159" Wheel Base (48" Driver Side & 86" Passenger Side)	48" & 86"	27-81025	27-2375
2014	2023	Ram	ProMaster 1500/2500/3500 (Single 54" Passenger Sliding Door)	54"	27-80095	27-2385
2014	2023	Ram	ProMaster 1500/2500/3500 (Single 54" Rear)	54"	27-74775	27-2395
2003	2009	Toyota	4Runner (Base Model) 1	68"	27-74715	27-1805
2005	2009	Toyota	4Runner 1	68"	27-74715	27-1805
2010	2023	Toyota	4Runner Limited Nightshade/TRD Sport (Excl. 40th Anniversary & Premium TRD Off-Road & Pro Trail Venture) 1	68"	27-74715	27-1945
2014	2023	Toyota	4Runner 40th Anniversary SR5 & Premium TRD Off-Road & Pro Trail Venture (Excl. Limited Nightshade/TRD Sport) 1	68"	27-74715	27-2165
2010	2011	Toyota	4Runner SR5 (Excl. Trail) 1	68"	27-74715	27-1945
2010	2017	Toyota	4Runner Trail (Excl. Limited) 1	68"	27-74715	27-2165
2008	2013	Toyota	Highlander 1	68"	27-74715	27-1855
2008	2022	Toyota	Sequoia	79"	27-74735	27-1875
2001	2007	Toyota	Sequoia 1	79"	27-74735	27-1325
2005	2023	Toyota	Tacoma Access Cab 1	68"	27-74715	27-1615
2005	2023	Toyota	Tacoma Double Cab 1/4	79"	27-74735	27-1615
2001	2004	Toyota	Tacoma Double Cab 4Dr 1	79"	27-74735	27-1605
2005	2023	Toyota	Tacoma Reg Cab 1	54"	27-74705	27-1625
2007	2021	Toyota	Tundra Crew Max 1	90"	27-74745	27-1725
2022	2025	Toyota	Tundra Crew Max 1	90"	27-74745	27-2485
2004	2006	Toyota	Tundra Double Cab	79"	27-74735	27-1325
2007	2021	Toyota	Tundra Double Cab 1	79"	27-74735	27-1725
2022	2023	Toyota	Tundra Double Cab 1	79"	27-74735	27-2485
2007	2018	Toyota	Tundra Reg Cab	54"	27-74705	27-1805

FOOTNOTES: 1. Not Compatible With OEM Skirt Cladding. 2. Requires Board To Be Shortened. 4. No Drilling Required. 5. Not Compatible With Mud Flaps. 7. Not Compatible On Vehicles With Power Retracting Boards If Equipped. 8. Not Compatible With Optional Light Kit Part # 27-60803. 10. Excludes Chassis Cab With Diesel Exhaust Fluid (DEF) Tank Vehicles. 19. Requires Drilling. 20. Requires Drilling On Vans Without Rocker Panel Studs.



RUNNING BOARDS

WESTIN

THRASHER RUNNING BOARDS

TEXTURED BLACK

- ▶ Mount kit included
- ▶ Pre-runner style look
- ▶ Protects vehicle rocker panels from potential damage
- ▶ 1-piece stamped steel construction
- ▶ Striking louver design
- ▶ Injection molded bracket covers included

FINISH: Textured Black Powder Coat

MATERIAL: E-Coated Steel

WARRANTY: 3-Year



START	END	MAKE	MODEL	BRACKET CVR	LENGTH (IN.)	BLACK
2007	2016	Chevrolet	Silverado 1500 Crew Cab (Excl. Classic)	Yes	86	20-01035
2019	2023	Chevrolet	Silverado 1500 Crew Cab (Excl. 2019 LD)	Yes	91	20-01275
2019	2023	Chevrolet	Silverado 1500 Double Cab (Excl. 2019 LD)	Yes	77	20-01265
2007	2019	Chevrolet	Silverado 2500/3500HD Crew Cab (Excl. Classic)	Yes	86	20-01035
2020	2023	Chevrolet	Silverado 2500/3500 Crew Cab	Yes	86	20-01035
2020	2023	Chevrolet	Silverado 2500/3500 Double Cab	Yes	77	20-01265
2009	2018	Dodge	Ram 1500 Crew Cab ¹	Yes	86	20-01055
2009	2018	Dodge	Ram 1500 Quad Cab ¹	Yes	77	20-01045
2010	2023	Dodge	Ram 2500/3500 Crew Cab ^{1,4}	Yes	86	20-01055
2015	2023	Ford	F-150 SuperCab	Yes	80	20-01085
2015	2023	Ford	F-150 SuperCrew	Yes	91	20-01095
2017	2023	Ford	F-250/350 Crew Cab	Yes	91	20-01095
2017	2023	Ford	F-250/350 SuperCab	Yes	80	20-01085
1999	2016	Ford	F-250/350/450/550 SuperCab	Yes	77	20-01105
2007	2016	GMC	Sierra 1500 Crew Cab (Excl. Classic)	Yes	86	20-01035
2019	2023	GMC	Sierra 1500 Crew Cab (Excl. 2019 Limited)	Yes	91	20-01275
2019	2023	GMC	Sierra 1500 Double Cab (Excl. 2019 Limited)	Yes	77	20-01265
2007	2019	GMC	Sierra 2500/3500HD Crew Cab (Excl. Classic)	Yes	86	20-01035
2017	2023	Nissan	Titan Crew Cab	Yes	86	20-01165
2018	2023	Nissan	Titan XD Crew Cab	Yes	86	20-01165
2016	2023	Ram	1500 Classic Crew Cab ¹	Yes	86	20-01055
2019	2023	Ram	1500 Classic Quad Cab ¹	Yes	77	20-01045
2009	2018	Ram	1500 Crew Cab ¹	Yes	86	20-01055
2009	2018	Ram	1500 Quad Cab ¹	Yes	77	20-01045
2010	2023	Ram	2500/3500 Crew Cab ^{1,4}	Yes	86	20-01055
2007	2021	Toyota	Tundra CrewMax	Yes	91	20-01155
2007	2021	Toyota	Tundra Double Cab	Yes	80	20-01145
2006	2022	Toyota	Tacoma Double Cab	Yes	80	20-01135
2007	2021	Toyota	Tundra CrewMax	Yes	91	20-01155
2007	2021	Toyota	Tundra Double Cab	Yes	80	20-01145

FOOTNOTES: 2. Requires Drilling To Pinch Weld For 2012 And Older Vehicles. 6. Excludes Chassis Cab With Diesel Exhaust Fluid (DEF) Tank Vehicles.

WESTIN[®] | RUNNING BOARDS

SURE-GRIP RUNNING BOARDS

POLISHED, BRUSHED AND BLACK ALUMINUM

- Vehicle specific mount kit required - sold separately
- Corrosion resistant extruded aluminum board
- Protects vehicle rocker panels from potential damage
- Slip resistant textured step surface
- Injection molded polymer end caps
- Rocker panel gap strip for finished look
- Optional light kit available (part no. 27-6000)

FINISH: Polished, Brushed & Black

MATERIAL: Extruded Rubber Step & Aluminum Board

WARRANTY: 3-Year



START	END	MAKE	MODEL	LENGTH (IN.)	POLISHED	BRUSHED	BLACK	REQUIRED MOUNT KIT
2009	2013	Acura	MDX	69"	27-6610	27-6110	27-6115	27-1965
2008	2017	Buick	Enclave [†]	70"	27-6620	27-6120	27-6125	27-1835
2002	2006	Chevrolet	Avalanche (W/ Cladding)	79"	27-6630	27-6130	27-6135	27-1645
2003	2013	Chevrolet	Avalanche (W/O Cladding)	99"	27-6640	27-6140	27-6145	27-1645
1997	2004	Chevrolet	Blazer 8-Series 4Dr	72"	27-6620	27-6120	27-6125	27-1105
1992	2000	Chevrolet	C/K Series Crew Cab (Excl. 1996+New Body Style) [†]	99"	27-6640	27-6140	27-6145	27-1045
1983	1996	Chevrolet	C/K Series Ext Cab	79"	27-6630	27-6130	27-6135	27-1005
2004	2012	Chevrolet	Colorado Crew Cab [†]	79"	27-6630	27-6130	27-6135	27-1995
2016	2022	Chevrolet	Colorado Crew Cab (Incl. Diesel) [†]	79"	27-6630	27-6130	27-6135	27-2205
2016	2022	Chevrolet	Colorado Ext Cab (Incl. Diesel) [†]	69"	27-6610	27-6110	27-6115	27-2205
1997	2004	Chevrolet	8-10 Pickup Ext Cab	72"	27-6620	27-6120	27-6125	27-1105
2001	2007	Chevrolet	Silverado "Classic" 1500/2500/3500HD Crew Cab	99"	27-6640	27-6140	27-6145	27-1265
1999	2007	Chevrolet	Silverado "Classic" 1500/2500LD Ext Cab	79"	27-6630	27-6130	27-6135	27-1025
1999	2007	Chevrolet	Silverado "Classic" 1500/2500LD Reg Cab	64"	27-6600	27-6100	27-6105	27-1465
2001	2007	Chevrolet	Silverado "Classic" 2500/3500HD Ext Cab	79"	27-6630	27-6130	27-6135	27-1025
2001	2007	Chevrolet	Silverado "Classic" 2500/3500HD Reg Cab	64"	27-6600	27-6100	27-6105	27-1465
2007	2013	Chevrolet	Silverado 1500 Crew Cab (Excl. Classic) [†]	69"	27-6650	27-6150	27-6155	27-1755
2014	2018	Chevrolet	Silverado 1500 Crew Cab [†]	69"	27-6650	27-6150	27-6155	27-2145
2019	2023	Chevrolet	Silverado 1500 Crew Cab	69"	27-6650	27-6150	27-6155	27-2255
2014	2019	Chevrolet	Silverado 1500 Double Cab [†]	79"	27-6630	27-6130	27-6135	27-2145
2019	2023	Chevrolet	Silverado 1500 Double Cab (Excl. 2019 LD)	79"	27-6630	27-6130	27-6135	27-2255
2007	2013	Chevrolet	Silverado 1500 Ext Cab (Excl. Classic) [†]	79"	27-6630	27-6130	27-6135	27-1745
2007	2013	Chevrolet	Silverado 1500 Reg Cab (Excl. Classic) [†]	64"	27-6600	27-6100	27-6105	27-1735
2014	2018	Chevrolet	Silverado 1500 Reg Cab [†]	64"	27-6600	27-6100	27-6105	27-2135
2020	2023	Chevrolet	Silverado 1500 Reg Cab	64"	27-6600	27-6100	27-6105	27-2235
2020	2023	Chevrolet	Silverado 2500/3500 Crew Cab	69"	27-6650	27-6150	27-6155	27-2255
2020	2023	Chevrolet	Silverado 2500/3500 Double Cab	79"	27-6630	27-6130	27-6135	27-2255
2007	2014	Chevrolet	Silverado 2500/3500 Reg Cab (Excl. 2007 Classic)(Incl. Diesel) [†]	64"	27-6600	27-6100	27-6105	27-1735
2007	2014	Chevrolet	Silverado 2500/3500HD Crew Cab (Excl. 2007 Classic)(Incl. Diesel) [†]	69"	27-6650	27-6150	27-6155	27-1795
2016	2019	Chevrolet	Silverado 2500/3500HD Crew Cab (Excl. Diesel) [†]	69"	27-6650	27-6150	27-6155	27-2145
2016	2019	Chevrolet	Silverado 2500/3500HD Double Cab (Excl. Diesel)	79"	27-6630	27-6130	27-6135	27-2145
2007	2014	Chevrolet	Silverado 2500/3500HD Ext Cab (Excl. 2007 Classic)(Incl. Diesel) [†]	79"	27-6630	27-6130	27-6135	27-1745
2016	2019	Chevrolet	Silverado 2500/3500HD Reg Cab (Excl. Diesel) [†]	64"	27-6600	27-6100	27-6105	27-2135
2019	2019	Chevrolet	Silverado LD Double Cab [†]	79"	27-6630	27-6130	27-6135	27-2145
1992	1999	Chevrolet	Suburban	99"	27-6640	27-6140	27-6145	27-1045
2000	2004	Chevrolet	Suburban (Excl. 2002-2004 27i)	99"	27-6640	27-6140	27-6145	27-1035
2005	2013	Chevrolet	Suburban (Excl. Hybrid & 27i) [†]	99"	27-6640	27-6140	27-6145	27-1645
1995	1999	Chevrolet	Tahoe 2Dr	72"	27-6620	27-6120	27-6125	27-1015
1996	1999	Chevrolet	Tahoe 4Dr	79"	27-6630	27-6130	27-6135	27-1015
2000	2004	Chevrolet	Tahoe 4Dr (Excl. 2002-2004 27i)	79"	27-6630	27-6130	27-6135	27-1035

CONTINUED ON NEXT PAGE →

SURE-GRIP RUNNING BOARDS CONTINUED

POLISHED, BRUSHED AND BLACK ALUMINUM

START	END	MAKE	MODEL	LENGTH (IN.)	POLISHED	BRUSHED	BLACK	REQUIRED MOUNT KIT
2005	2014	Chevrolet	Tahoe 4Dr (Excl. Hybrid & Z71) ¹	79"	27-6630	27-6130	27-6135	27-1643
2002	2009	Chevrolet	Trailblazer	72"	27-6620	27-6120	27-6125	27-1099
2009	2017	Chevrolet	Traverse ¹	72"	27-6620	27-6120	27-6125	27-1839
2018	2022	Chevrolet	Traverse ¹	79"	27-6630	27-6130	27-6135	27-2275
2006	2009	Chrysler	Aspen	79"	27-6630	27-6130	27-6135	27-1549
2004	2010	Dodge	Durango ¹	79"	27-6630	27-6130	27-6135	27-1849
2011	2017	Dodge	Durango ¹	79"	27-6630	27-6130	27-6135	27-1975
1994	2001	Dodge	Ram 1500 3Dr & Quad Cab	79"	27-6630	27-6130	27-6135	27-1186
2009	2018	Dodge	Ram 1500 Crew Cab	89"	27-6650	27-6150	27-6155	27-1908
2002	2008	Dodge	Ram 1500 Quad Cab (Excl. Daytona, Rumble Bee, & SRT-10)	79"	27-6630	27-6130	27-6135	27-1379
2009	2018	Dodge	Ram 1500 Quad Cab ¹	79"	27-6630	27-6130	27-6135	27-1908
2009	2018	Dodge	Ram 1500 Reg Cab	64"	27-6600	27-6100	27-6105	27-1896
1994	2002	Dodge	Ram 2500/3500 3Dr & Quad Cab	79"	27-6630	27-6130	27-6135	27-1186
2010	2020	Dodge	Ram 2500/3500 Crew Cab ¹	89"	27-6650	27-6150	27-6155	27-1908
2003	2009	Dodge	Ram 2500/3500 Quad Cab (Excl. Daytona, Rumble Bee, & SRT-10)	79"	27-6630	27-6130	27-6135	27-1379
2010	2020	Dodge	Ram 2500/3500 Reg Cab ¹	64"	27-6600	27-6100	27-6105	27-1896
2008	2009	Dodge	Ram 4500/5500 Quad Cab	79"	27-6630	27-6130	27-6135	27-1379
2021	2023	Ford	Bronco 2Dr (Excl. Bronco Sport)	54"	27-6600	27-6100	27-6105	27-2425
2021	2023	Ford	Bronco 4Dr (Excl. Bronco Sport)	74"	27-6620	27-6120	27-6125	27-2425
2007	2014	Ford	Edge (Excl. Sport) (Excl. EcoBoost) ^{1, A, H}	72"	27-6620	27-6120	27-6125	27-1825
1999	2009	Ford	Excursion ¹	93"	27-6640	27-6140	27-6145	27-1216
1997	2008	Ford	Expedition	79"	27-6630	27-6130	27-6135	27-1816
2007	2014	Ford	Expedition ¹	79"	27-6630	27-6130	27-6135	27-1816
2007	2014	Ford	Expedition EL ^{1, H}	99"	27-6640	27-6140	27-6145	27-1816
1996	2001	Ford	Explorer 4Dr (Excl. Sport, Excl. 2002 Body Style) ^{1, A}	72"	27-6620	27-6120	27-6125	27-1116
2002	2005	Ford	Explorer 4Dr (Excl. Sport)	79"	27-6630	27-6130	27-6135	27-1348
2006	2010	Ford	Explorer 4Dr ¹	79"	27-6630	27-6130	27-6135	27-1675
2011	2019	Ford	Explorer 4Dr	72"	27-6620	27-6120	27-6125	27-1968
2020	2023	Ford	Explorer 4Dr ¹	79"	27-6630	27-6130	27-6135	27-2285
2007	2010	Ford	Explorer Sport Trac ¹	79"	27-6630	27-6130	27-6135	27-1798
2004	2012	Ford	F-150 Reg Cab (Excl. 2004 Heritage) ^{1, A, H}	69"	27-6610	27-6110	27-6115	27-1538
2016	2020	Ford	F-150 Reg Cab	64"	27-6600	27-6100	27-6105	27-2178
2004	2014	Ford	F-150 SuperCab (Excl. 2004 Heritage) ¹	79"	27-6630	27-6130	27-6135	27-1528
2016	2020	Ford	F-150 SuperCab	79"	27-6630	27-6130	27-6135	27-2178
2001	2005	Ford	F-150 SuperCrew	79"	27-6630	27-6130	27-6135	27-1265
2004	2008	Ford	F-150 SuperCrew (Excl. 2004 Heritage) ¹	89"	27-6650	27-6150	27-6155	27-1838
2009	2014	Ford	F-150 SuperCrew ¹	93"	27-6640	27-6140	27-6145	27-1838
2016	2020	Ford	F-150 SuperCrew	93"	27-6640	27-6140	27-6145	27-2196
1997	2004	Ford	F-150 2500 SuperCab, 3 & 4Dr (2004 Heritage Only)	72"	27-6620	27-6120	27-6125	27-1265
2017	2020	Ford	F-250/350 Crew Cab	93"	27-6640	27-6140	27-6145	27-2196
2017	2020	Ford	F-250/350 Reg Cab	64"	27-6600	27-6100	27-6105	27-2178
1999	2016	Ford	F-250/350 Super Duty Crew Cab ¹	93"	27-6640	27-6140	27-6145	27-1216
1999	2016	Ford	F-250/350 Super Duty SuperCab	79"	27-6630	27-6130	27-6135	27-1205
2017	2020	Ford	F-250/350 SuperCab	79"	27-6630	27-6130	27-6135	27-2178
1998	2002	Ford	Ranger Ext Cab 4Dr ^{1, A, H}	72"	27-6620	27-6120	27-6125	27-1148
2019	2021	Ford	Ranger SuperCab	69"	27-6610	27-6110	27-6115	27-2265
2019	2021	Ford	Ranger SuperCrew	79"	27-6630	27-6130	27-6135	27-2265
2007	2016	GMC	Acadia (Excl. Denali) ¹	72"	27-6620	27-6120	27-6125	27-1838
2004	2012	GMC	Canyon Crew Cab ¹	79"	27-6630	27-6130	27-6135	27-1598
2016	2022	GMC	Canyon Crew Cab (Incl. Diesel) ¹	79"	27-6630	27-6130	27-6135	27-2285
2016	2022	GMC	Canyon Ext Cab (Incl. Diesel) ¹	69"	27-6610	27-6110	27-6115	27-2285
2002	2010	GMC	Envoy (Excl. XUV)	72"	27-6620	27-6120	27-6125	27-1358
1997	2004	GMC	Jimmy S-Series 4Dr	72"	27-6620	27-6120	27-6125	27-1108
1999	2007	GMC	Sierra Classic ¹ 1500/2500LD Ext Cab	79"	27-6630	27-6130	27-6135	27-1025
1999	2007	GMC	Sierra Classic ¹ 1500/2500LD Reg Cab	64"	27-6600	27-6100	27-6105	27-1458
2001	2007	GMC	Sierra Classic ¹ 2500/3500HD Ext Cab	79"	27-6630	27-6130	27-6135	27-1025
2001	2007	GMC	Sierra Classic ¹ 2500/3500HD Reg Cab	64"	27-6600	27-6100	27-6105	27-1458
2007	2019	GMC	Sierra 1500 Crew Cab (Excl. Classic) ¹	89"	27-6650	27-6150	27-6155	27-1755
2014	2018	GMC	Sierra 1500 Crew Cab ¹	89"	27-6650	27-6150	27-6155	27-2149
2019	2020	GMC	Sierra 1500 Crew Cab	89"	27-6650	27-6150	27-6155	27-2256
2014	2018	GMC	Sierra 1500 Double Cab ¹	79"	27-6630	27-6130	27-6135	27-2149
2019	2020	GMC	Sierra 1500 Double Cab (Excl. 2019 Limited)	79"	27-6630	27-6130	27-6135	27-2245
2007	2013	GMC	Sierra 1500 Ext Cab (Excl. Classic) ¹	79"	27-6630	27-6130	27-6135	27-1746
2019	2019	GMC	Sierra 1500 Limited Double Cab ¹	79"	27-6630	27-6130	27-6135	27-2149
2007	2013	GMC	Sierra 1500 Reg Cab (Excl. Classic) ¹	64"	27-6600	27-6100	27-6105	27-1738
2014	2018	GMC	Sierra 1500 Reg Cab ¹	64"	27-6600	27-6100	27-6105	27-2138
2020	2023	GMC	Sierra 2500/3500 Crew Cab	89"	27-6650	27-6150	27-6155	27-2256
2020	2023	GMC	Sierra 2500/3500 Double Cab	79"	27-6630	27-6130	27-6135	27-2256
2007	2014	GMC	Sierra 2500/3500 Reg Cab (Excl. 2007 Classic/Incl. Diesel) ¹	64"	27-6600	27-6100	27-6105	27-1738
2007	2014	GMC	Sierra 2500/3500HD Crew Cab (Excl. 2007 Classic/Incl. Diesel) ¹	89"	27-6650	27-6150	27-6155	27-1755
2016	2019	GMC	Sierra 2500/3500HD Crew Cab (Excl. Diesel) ¹	89"	27-6650	27-6150	27-6155	27-2149
2016	2019	GMC	Sierra 2500/3500HD Double Cab (Excl. Diesel)	79"	27-6630	27-6130	27-6135	27-2149
2007	2014	GMC	Sierra 2500/3500HD Ext Cab (Excl. 2007 Classic/Incl. Diesel) ¹	79"	27-6630	27-6130	27-6135	27-1746
2016	2019	GMC	Sierra 2500/3500HD Reg Cab (Excl. Diesel) ¹	64"	27-6600	27-6100	27-6105	27-2138
1997	2004	GMC	Sonoma Ext Cab	72"	27-6620	27-6120	27-6125	27-1109
1998	1999	GMC	Yukon 2Dr	72"	—	27-6120	27-6125	27-1016
1996	1999	GMC	Yukon 4Dr	79"	27-6630	27-6130	27-6135	27-1016
2000	2004	GMC	Yukon 4Dr (Excl. 2002-2004 Z71) ¹	79"	27-6630	27-6130	27-6135	27-1038
2006	2013	GMC	Yukon 4Dr (Excl. Hybrid & Z71) ¹	79"	27-6630	27-6130	27-6135	27-1649
2003	2004	GMC	Yukon XL (Excl. 2003-2004 Z71)	89"	27-6640	27-6140	27-6145	27-1038
2006	2013	GMC	Yukon XL (Excl. Hybrid & Z71) ¹	89"	27-6640	27-6140	27-6145	27-1649
2002	2008	Honda	CR-V	89"	27-6610	27-6110	27-6115	27-1438

CONTINUED ON NEXT PAGE →

SURE-GRIP RUNNING BOARDS CONTINUED POLISHED, BRUSHED AND BLACK ALUMINUM

START	END	MAKE	MODEL	LENGTH (IN.)	POLISHED	BRUSHED	BLACK	REQUIRED MOUNT KIT
2003	2008	Honda	Pilot	69"	27-6610	27-6110	27-6115	27-1445
2009	2012	Honda	Pilot	69"	27-6610	27-6110	27-6115	27-1905
2006	2014	Honda	Ridgeline ^{1,4}	85"	27-6650	27-6150	27-6155	27-1775
2007	2012	Hyundai	Santa Fe ⁴	69"	27-6610	27-6110	27-6115	27-1845
2004	2009	Infiniti	QX	79"	27-6630	27-6130	27-6135	27-1565
2003	2008	Isuzu	Ascender (5 Passenger)	72"	27-6620	27-6120	27-6125	27-1355
2006	2008	Isuzu	i-Series Crew Cab	79"	27-6630	27-6130	27-6135	27-1595
2006	2010	Jeep	Commander ¹	72"	27-6620	27-6120	27-6125	27-1705
2006	2010	Jeep	Grand Cherokee ¹	72"	27-6620	27-6120	27-6125	27-1785
2011	2017	Jeep	Grand Cherokee (Excl. Diesel) ¹	69"	27-6610	27-6110	27-6115	27-1975
2006	2008	Lincoln	Mark LT	85"	27-6650	27-6150	27-6155	27-1635
2007	2015	Lincoln	MKX (Excl. EcoBoost) ^{14,15}	72"	27-6620	27-6120	27-6125	27-1825
2002	2005	Mercury	Mountaineer	79"	27-6630	27-6130	27-6135	27-1345
2006	2010	Mercury	Mountaineer ^{1,7}	79"	27-6630	27-6130	27-6135	27-1675
2004	2015	Nissan	Armada	79"	27-6630	27-6130	27-6135	27-1565
2005	2021	Nissan	Frontier Crew Cab ¹	79"	27-6630	27-6130	27-6135	27-1635
2022	2023	Nissan	Frontier Crew Cab	79"	27-6630	27-6130	27-6135	27-2435
2006	2021	Nissan	Frontier Ext. King Cab ¹	69"	27-6610	27-6110	27-6115	27-1635
2022	2023	Nissan	Frontier King Cab	69"	27-6610	27-6110	27-6115	27-2435
2005	2012	Nissan	Pathfinder ¹	72"	27-6620	27-6120	27-6125	27-1635
2004	2015	Nissan	Titan Crew Cab ¹	79"	27-6630	27-6130	27-6135	27-1565
2004	2015	Nissan	Titan Ext. King Cab ¹	72"	27-6620	27-6120	27-6125	27-1565
2002	2004	Oldsmobile	Bravada	72"	27-6620	27-6120	27-6125	27-1355
2019	2023	Ram	1500 Classic Crew Cab	89"	27-6690	27-6190	27-6195	27-1905
2019	2023	Ram	1500 Classic Quad Cab	79"	27-6630	27-6130	27-6135	27-1905
2019	2023	Ram	1500 Classic Reg. Cab	54"	27-6600	27-6100	27-6105	27-1895
2009	2018	Ram	1500 Crew Cab	89"	27-6690	27-6190	27-6195	27-1905
2009	2009	Ram	1500 Crew Cab (Excl. Classic)	89"	27-6690	27-6190	27-6195	27-2245
2009	2018	Ram	1500 Quad Cab	79"	27-6630	27-6130	27-6135	27-1905
2009	2023	Ram	1500 Quad Cab (Excl. Classic)	79"	27-6630	27-6130	27-6135	27-2245
2009	2018	Ram	1500 Reg. Cab	54"	27-6600	27-6100	27-6105	27-1895
2010	2023	Ram	2500/3500 Crew Cab ¹⁴	89"	27-6690	27-6190	27-6195	27-1905
2010	2023	Ram	2500/3500 Reg. Cab ¹⁴	54"	27-6600	27-6100	27-6105	27-1895
2007	2010	Saturn	Outlook ¹	72"	27-6620	27-6120	27-6125	27-1835
2003	2009	Toyota	4Runner (Base Model) ¹	69"	27-6610	27-6110	27-6115	27-1505
2008	2009	Toyota	4Runner ¹	72"	27-6620	27-6120	27-6125	27-1805
2010	2023	Toyota	4Runner Limited/Nightshade/TRD Sport (Excl. 40th Anniv/SRS & Premium/TRD Off-Road & Pro/Trail/Venture) ¹	72"	27-6620	27-6120	27-6125	27-1945
2010	2013	Toyota	4Runner SRS (Excl. Trail) ¹	72"	27-6620	27-6120	27-6125	27-1945
2014	2023	Toyota	4Runner 40th Anniv/SRS & Premium/TRD Off-Road & Pro/Trail/Venture (Excl. Limited/Nightshade/TRD Sport) ¹	72"	27-6620	27-6120	27-6125	27-2165
2010	2017	Toyota	4Runner Trail (Excl. Limited) ¹	69"	27-6610	27-6110	27-6115	27-2165
2001	2007	Toyota	Highlander (Excl. Hybrid) ^{1,4}	72"	27-6620	27-6120	27-6125	27-1365
2008	2019	Toyota	Highlander ¹	72"	27-6620	27-6120	27-6125	27-1855
2001	2007	Toyota	Sequoia ¹	79"	27-6630	27-6130	27-6135	27-1325
2008	2022	Toyota	Sequoia ¹	79"	27-6630	27-6130	27-6135	27-1875
1999	2004	Toyota	Tacoma Access Cab	72"	27-6620	27-6120	27-6125	27-1085
2005	2023	Toyota	Tacoma Access Cab ¹	72"	27-6620	27-6120	27-6125	27-1615
2001	2004	Toyota	Tacoma Double Cab 4Dr ¹	79"	27-6630	27-6130	27-6135	27-1605
2008	2023	Toyota	Tacoma Double Cab ^{14,15}	79"	27-6630	27-6130	27-6135	27-1615
2005	2014	Toyota	Tacoma Reg. Cab ¹	54"	27-6600	27-6100	27-6105	27-1625
1999	2006	Toyota	Tundra Access Cab	72"	27-6620	27-6120	27-6125	27-1195
2007	2021	Toyota	Tundra Crew Max ¹	93"	27-6640	27-6140	27-6145	27-1725
2022	2023	Toyota	Tundra Crew Max ¹	93"	27-6640	27-6140	27-6145	27-2485
2004	2006	Toyota	Tundra Double Cab	79"	27-6630	27-6130	27-6135	27-1225
2007	2021	Toyota	Tundra Double Cab ¹	79"	27-6630	27-6130	27-6135	27-1725
2022	2023	Toyota	Tundra Double Cab ¹	79"	27-6630	27-6130	27-6135	27-2485
2007	2017	Toyota	Tundra Reg. Cab ^{1,4}	54"	27-6600	27-6100	27-6105	27-1805

FOOTNOTES: 1. Not Compatible With OEM Skirt Cladding. 2. Requires Board To Be Shortened. 3. Models With Mud Flaps, Use 68 Inch Boards (27-6110/6115/6510). 4. No Drilling Required. 5. Excludes Vehicles With Mud Flaps. 7. Not Compatible On Vehicles With Power Retracting Boards If Equipped. 8. Not Compatible With Optional Light Kit Part # 27-80000. 14. Requires Minor Trimming Of Driver/Left Side Splash Shield. 15. Excludes Chassis Cab With Diesel Exhaust Fluid (DEF) Tank Vehicles. 19. Requires Drilling.

RUNNING BOARDS

WESTIN®

MOLDED RUNNING BOARDS

BLACK MOLDED ALUMINUM

- » Vehicle specific mount kit required - sold separately
- » Injection molded top aluminum board
- » Protects vehicle rocker panels from potential damage
- » Factory style design
- » UV resistant black molded polymer
- » Available in lighted and unlighted

FINISH: Black

MATERIAL: Molded Polymer Step & Aluminum Board

WARRANTY: 5 Year



START	END	MAKE	MODEL	LENGTH (IN.)	UNLIGHTED	LIGHTED	REQUIRED MOUNT KIT
2002	2006	Chevrolet	Avalanche (w/ Cladding)	75	27-0010	27-0015	27-1645
2003	2010	Chevrolet	Avalanche (w/o Cladding)	90	27-0020	27-0025	27-1645
1997	2004	Chevrolet	Bazer 9-Series 4Dr 2	72	27-0000	27-0005	27-1105
1992	2000	Chevrolet	C/K Series Crew Cab (Excl. 1999-2000 New Body Style) 5'	95	27-0020	27-0025	27-1045
1993	1999	Chevrolet	C/K Series Ext Cab	79	27-0010	27-0015	27-1005
2015	2022	Chevrolet	Colorado Crew Cab 1	79	27-0010	27-0015	27-2295
1997	2004	Chevrolet	S-10 Pickup Ext Cab 2	72	27-0000	27-0005	27-1105
2001	2007	Chevrolet	Silverado "Classic" 1500/2500/3500HD Crew Cab	95	27-0020	27-0025	27-1205
1999	2007	Chevrolet	Silverado "Classic" 1500/2500LD Ext Cab	79	27-0010	27-0015	27-1025
2001	2007	Chevrolet	Silverado "Classic" 2500/3500HD Ext Cab	79	27-0010	27-0015	27-1025
2014	2018	Chevrolet	Silverado 1500 Double Cab 1	79	27-0010	27-0015	27-2145
2007	2013	Chevrolet	Silverado 1500 Ext Cab 1	79	27-0010	27-0015	27-1745
2015	2019	Chevrolet	Silverado 2500/3500 Double Cab	79	27-0010	27-0015	27-2145
2007	2014	Chevrolet	Silverado 2500/3500 Ext Cab 1	79	27-0010	27-0015	27-1745
2019	2019	Chevrolet	Silverado LD Double Cab 1	79	27-0010	27-0015	27-2145
2000	2004	Chevrolet	Suburban (Excl. 2002-2004 Z71) 2	95	27-0020	27-0025	27-1035
2005	2010	Chevrolet	Suburban (Excl. Hybrid & Z71) 1, 2	93	27-0020	27-0025	27-1645
1992	1999	Chevrolet	Suburban 2	90	27-0020	27-0025	27-1045
1995	1999	Chevrolet	Tahoe 2Dr 2	72	27-0000	27-0005	27-1015
1995	1999	Chevrolet	Tahoe 4Dr 2	79	27-0010	27-0015	27-1015
2000	2004	Chevrolet	Tahoe 4Dr (Excl. 2002-2004 Z71) 2	79	27-0010	27-0015	27-1035
2005	2014	Chevrolet	Tahoe 4Dr (Excl. Hybrid & Z71) 1	79	27-0010	27-0015	27-1645
2002	2009	Chevrolet	Trailblazer	72	27-0000	27-0005	27-1355
2008	2022	Chevrolet	Traverse	79	27-0010	27-0015	27-2275
2006	2009	Chrysler	Aspen	79	27-0010	27-0015	27-1545
2004	2010	Dodge	Durango 1	79	27-0010	27-0015	27-1545
1994	2001	Dodge	Ram 1500 3Dr & Quad Cab 2	79	27-0010	27-0015	27-1105
2002	2008	Dodge	Ram 1500 Quad Cab (Excl. Daytona, Rumble Bee, & SRT-10)	79	27-0010	27-0015	27-1375
2009	2016	Dodge	Ram 1500 Quad Cab	79	27-0010	27-0015	27-1905
1994	2002	Dodge	Ram 2500/3500 3Dr & Quad Cab 2	75	27-0010	27-0015	27-1105

CONTINUED ON NEXT PAGE →

MOLDED RUNNING BOARDS CONTINUED

POLISHED, BRUSHED AND BLACK ALUMINUM

START	END	MAKE	MODEL	LENGTH (IN.)	UNLIGHTED	LIGHTED	REQUIRED MOUNT KIT
2003	2009	Dodge	Ram 2500/3500 Quad Cab (Excl. Cayote, Rumble Bee, & BRT-10)	79	27-0010	27-0015	27-1375
2003	2009	Dodge	Ram 4500/6500 Quad Cab	79	27-0010	27-0015	27-1375
2001	2003	Ford	Bronco 4Dr (Excl. Bronco Sport)	72	27-0000	27-0005	27-2425
2007	2014	Ford	Edge	72	27-0000	27-0005	27-1025
1998	2005	Ford	Excursion ¹	93	27-0020	27-0025	27-1215
1997	2006	Ford	Expedition	79	27-0010	27-0015	27-1015
2007	2014	Ford	Expedition (Excl. FunKmaster Flex) ^{1, 4}	79	27-0010	27-0015	27-1015
2007	2014	Ford	Expedition EL (Excl. FunKmaster Flex) ^{1, 4}	93	27-0020	27-0025	27-1015
1995	2001	Ford	Explorer 4Dr (Excl. Sport) (Excl. 2002 Body Style) ¹	72	27-0000	27-0005	27-1115
2002	2006	Ford	Explorer 4Dr (Excl. Sport)	79	27-0010	27-0015	27-1245
2020	2023	Ford	Explorer 4Dr	79	27-0010	27-0015	27-2285
2006	2010	Ford	Explorer ¹	79	27-0010	27-0015	27-1675
2007	2010	Ford	Explorer Sport Trac ¹	79	27-0010	27-0015	27-1795
2004	2008	Ford	F-150 SuperCab ¹	79	27-0010	27-0015	27-1525
2009	2014	Ford	F-150 SuperCab	79	27-0010	27-0015	27-1525
2001	2003	Ford	F-150 SuperCrew	79	27-0010	27-0015	27-1265
2009	2014	Ford	F-150 SuperCrew ¹	93	27-0020	27-0025	27-1085
1997	2004	Ford	F-150/2500 SuperCab, 3 & 4Dr (2004 Heritage Only)	72	27-0000	27-0005	27-1265
1999	2016	Ford	F-250/350 Super Duty Crew Cab	93	27-0020	27-0025	27-1215
1999	2016	Ford	F-250/350 Super Duty SuperCab	79	27-0010	27-0015	27-1205
1992	2002	Ford	Ranger Ext Cab 4Dr ^{1, 2, 3}	72	27-0000	27-0005	27-1145
2015	2022	GMC	Canyon Crew Cab ¹	79	27-0010	27-0015	27-2295
2002	2010	GMC	Envoy (Excl. XUV)	72	27-0000	27-0005	27-1355
1997	2004	GMC	Jimmy S-Series 4Dr	72	27-0000	27-0005	27-1105
1999	2007	GMC	Sierra Classic ¹ 1500/2500LD Ext Cab	79	27-0010	27-0015	27-1025
2001	2007	GMC	Sierra Classic ¹ 2500/3500HD Ext Cab	79	27-0010	27-0015	27-1025
2014	2018	GMC	Sierra 1500 Double Cab ¹	79	27-0010	27-0015	27-2145
2007	2010	GMC	Sierra 1500 Ext Cab (Excl. Classic) ¹	79	27-0010	27-0015	27-1745
2019	2019	GMC	Sierra 1500 Limited Double Cab ¹	79	27-0010	27-0015	27-2145
2007	2014	GMC	Sierra 2500/3500 Ext Cab (Excl. Classic) ¹	79	27-0010	27-0015	27-1745
2015	2019	GMC	Sierra 2500/3500HD Double Cab	79	27-0010	27-0015	27-2145
1997	2004	GMC	Sonoma Ext Cab ¹	72	27-0000	27-0005	27-1105
1996	1999	GMC	Yukon 2Dr	72	27-0000	27-0005	27-1015
1998	1999	GMC	Yukon 4Dr	79	27-0010	27-0015	27-1015
2002	2004	GMC	Yukon 4Dr (Excl. 2002-2004 271) ^{1, 2}	79	27-0010	27-0015	27-1035
2005	2014	GMC	Yukon 4Dr (Excl. Hybrid & 271) ^{1, 2}	79	27-0010	27-0015	27-1645
2002	2004	GMC	Yukon XL (Excl. 2002-2004 271) ¹	93	27-0020	27-0025	27-1035
2005	2013	GMC	Yukon XL (Excl. Hybrid & 271) ^{1, 2}	93	27-0020	27-0025	27-1645
2004	2009	Infini	QX	79	27-0010	27-0015	27-1585
2003	2008	Isuzu	Ascender (5 Passenger)	72	27-0000	27-0005	27-1095
2007	2015	Lincoln	MKX	72	27-0000	27-0005	27-1025
2002	2005	Mercury	Mountaineer	79	27-0010	27-0015	27-1345
2005	2010	Mercury	Mountaineer ^{1, 2}	79	27-0010	27-0015	27-1675
2004	2015	Nissan	Armada	79	27-0010	27-0015	27-1565
2005	2021	Nissan	Frontier Crew Cab ¹	79	27-0010	27-0015	27-1635
2002	2003	Nissan	Frontier Crew Cab	79	27-0010	27-0015	27-2435
2022	2023	Nissan	Frontier King Cab	79	27-0010	27-0015	27-2435
2008	2012	Nissan	Pathfinder ¹	72	27-0000	27-0005	27-1635
2004	2015	Nissan	Titan Crew Cab ¹	79	27-0010	27-0015	27-1565
2004	2015	Nissan	Titan Ext King Cab ¹	72	27-0000	27-0005	27-1565
2002	2004	Oldsmobile	Brevada	72	27-0000	27-0005	27-1355
2019	2023	Ram	Classic Quad Cab	79	27-0010	27-0015	27-1905
2009	2018	Ram	1500 Quad Cab	79	27-0010	27-0015	27-1905
2005	2009	Toyota	4Runner ¹	72	27-0000	27-0005	27-1505
2010	2013	Toyota	4Runner (Excl. Trail) ¹	72	27-0000	27-0005	27-1945
2010	2023	Toyota	4Runner Limited/Nightshade/TRD Sport (Excl. 40th Anni/SRS & Premium/TRD Off-Road & Pro/Trail/Venture)	72	27-0000	27-0005	27-1945
2014	2023	Toyota	4Runner 40th Anni/SRS & Premium/TRD Off-Road & Pro/Trail/Venture (Excl. Limited/Nightshade/TRD Sport)	72	27-0000	27-0005	27-2165
2010	2014	Toyota	4Runner Trail (Excl. Limited)	72	27-0000	27-0005	27-2165
2001	2007	Toyota	Highlander (Excl. Hybrid) ¹	72	27-0000	27-0005	27-1365
2001	2007	Toyota	Sequoia ¹	79	27-0010	27-0015	27-1325
2003	2022	Toyota	Sequoia	79	27-0010	27-0015	27-1875
1999	2004	Toyota	Tacoma Access Cab	72	27-0000	27-0005	27-1085
2005	2023	Toyota	Tacoma Access Cab ¹	72	27-0000	27-0005	27-1615
2001	2004	Toyota	Tacoma Double Cab 4Dr ¹	79	27-0010	27-0015	27-1695
2005	2023	Toyota	Tacoma Double Cab ¹	79	27-0010	—	27-1615
1999	2008	Toyota	Tundra Access Cab	72	27-0000	27-0005	27-1155
2007	2021	Toyota	Tundra Crew Max ¹	93	27-0020	27-0025	27-1725
2004	2006	Toyota	Tundra Double Cab	79	27-0010	27-0015	27-1225
2007	2021	Toyota	Tundra Double Cab ¹	79	27-0010	27-0015	27-1725

FOOTNOTES: 1. No Drilling Required. 2. Use Molded Board Gap Strip Part# 27-9901 (sold separately). 3. Not Compatible On Vehicles With Power Retracting Boards If Equipped. 4. Fits Vehicles With Pinch Weld Only.

NERF STEP BARS / RUNNING BOARDS REPLACEMENT SERVICE KITS

HDX DROP STEP PAD (15.5")
56-10001



HDX DROP STEP PAD (11")
56-10002



HDX XTREME
56-20001



PRO TRAXX 4
21-20001



PRO TRAXX 5
21-50001



PLATINUM 4
21-0001



APPLICATION	DESCRIPTION	PART NO.
E-Series 3 Step Pad & Clips	Replacement Service Kit with 21in pad	23-0001
GenX Step Pad	Replacement Service Kit with 10in pad	20-0001
HDX Drop Step Pad	6" step pad w/ fasteners (Set of 2)	56-10003
HDX Drop Step Pad	Replacement service kit includes 11 inch die stamped step pad and fasteners	56-10002
HDX Drop Step Pad	Replacement service kit includes 15.5 inch die stamped step pad and fasteners	56-10001
HDX Xtreme Step Pad	Replacement service kit includes 17.75 inch step pad and fasteners	56-20001
Pin Oval Step Pads	Step Pad Pins Oval Tube	80-8239
Platinum 3 Step Pad & Clips	Replacement Service Kit with 20in pad	25-0001
Platinum 4 Pad & Clips	Replacement Service Kit with 24in pad	21-0001
Platinum 4 WTW Step Pad & Clips	Replacement Service Kit with 14in pad	24-50014
Platinum 4 WTW Step Pad & Clips	Replacement Service Kit with 20in pad	24-50020
Platinum 4 WTW Step Pad & Clips	Replacement Service Kit with 24in pad	24-50024
Premier 4 in. Oval Front Step Pad	Replacement Service Kit with 25in pad	25-5001
Premier 4 in. Oval Rear Step Pad	Replacement Service Kit with 18in pad	25-5002
Premier 5 Step Pad & Clips	Replacement Service Kit with 20in pad	20-5003
Premier Step Pad	Premier 6 in Oval Step Pad	30-0169
Pro Traxx 4 Step Pad & Clips	Replacement Service Kit with 24in pad (5 stud)	21-20001-5
Pro Traxx 4 Step Pad & Clips	Replacement Service Kit with 24in pad (6 stud)	21-20001
Pro Traxx 5 Step Pad & Clips	Replacement Service Kit with 14in pad	21-50002
Pro Traxx 5 Step Pad & Clips	Replacement Service Kit with 24in pad	21-50001
Pro Traxx 6 Step Pad & Clips	Replacement Service Kit with 24in pad	21-50001
R5 Nerf Step Bar Pad & Clips	Replacement Service Kit with 20.5in pad	20-50002
R5 Nerf Step Bar Pad & Clips	Replacement Service Kit with 23.5in pad	20-50001
R7 Nerf Step Bar Pad & Clips	Replacement Service Kit with 22in pad	20-70002
R7 Nerf Step Bar Pad & Clips	Replacement Service Kit with 21.5in pad	20-70001
Rack Slider Repl Pad	13.25 step pad with fasteners	42-7001
Signature 3 Step Pad & Clips	Replacement Service Kit with 20in pad	25-0001





NEW! - XTS Brush Guard61



NEW! - HDX Modular Grille Guard62



Sportsman X Grille Guard63



HDX Grille Guard64



HDX Winch Mount Grille Guard66



Sportsman Grille Guard67



HDX B-Force Flush Mount LED Kit69



MAX Winch Mounting System69



Sensor Re-locator, and HDX Light Clamps71



License Plate Re-locator71

NEW! XTS BRUSH GUARD FOR WESTIN XTS FRONT BUMPER

TEXTURED BLACK

- » 2" diameter tubing for maximum durability
- » Constructed of 10-gauge steel uprights for strength and style
- » Wraparound brush guards protects headlights and grille from damage
- » Designed to mount onto Westin XTS Front Bumper (sold separately)
- » Optional light mounting center bars
- » Clears most winches up to 12,000 lbs. capacity
- » Compatible with all factory sensors
- » Optional round LED light kit with Westin auxiliary lights available (sold separately)
- » Optional square LED light kit with Westin auxiliary lights available (sold separately)
- » Bolt-on installation - no drilling required
- » Hardware and mounting brackets included
- » Electrostatic base coat provides long lasting corrosion protection
- » Available in textured black finish

FINISH: Textured Black Powder Coat
 MATERIAL: E-Coated Steel
 WARRANTY: 3-Year



OPTIONAL PRODUCTS FOR XTS BRUSH GUARD



SX 10SR
P/N 1718201



SX 12SR
P/N 1712201



XTS FRONT BUMPER
P/N 59-711255



FUSION5 SINGLE ROW LIGHT BAR
P/N 09-12232-PR



OPTIONAL HYPERQ B-FORCE P/N 09-12205A-PR OR
HYPERQ LED LIGHTS P/N 09-12200A-PR

START END MAKE MODEL

2021 2023 Ford Bronco (Excl. Bronco Sport, Heritage, Heritage Limited)

TEXTURED BLACK

39-761255

NEW! XTS BRUSH GUARD FOR OE STEEL FRONT BUMPER

TEXTURED BLACK

- » 2" diameter tubing for maximum durability
- » Constructed of 10-gauge steel uprights for strength and style
- » Wraparound brush guards protects headlights and grille from damage
- » Designed for OE steel bumper
- » Bolt-on design using factory holes
- » Clears most winches up to 12,000 lbs. capacity
- » Compatible with all factory sensors
- » Optional light mounting center bars
- » Optional round LED light kit with Westin auxiliary lights available (sold separately)
- » Optional square LED light kit with Westin auxiliary lights available (sold separately)
- » Bolt-on installation - no drilling required
- » Hardware and mounting brackets included
- » Electrostatic base coat provides long lasting corrosion protection
- » Available in textured black finish

FINISH: Textured Black Powder Coat
 MATERIAL: E-Coated Steel
 WARRANTY: 3-Year



OPTIONAL ACCESSORIES:

OPTIONAL LIGHT MOUNTING
CENTER BARS



AXIS LED
AUXILIARY LIGHTS
P/N 09-12007A-PR (SPOT)



AXIS LED
AUXILIARY LIGHTS
P/N 09-12007B-PR (FLOOD)

START END MAKE MODEL

2021 2023 Ford Bronco (Excl. Bronco Sport, Heritage, Heritage Limited)

TEXTURED BLACK

39-761255

WESTIN® GRILLE GUARDS

NEW! HDX MODULAR GRILLE GUARD

BLACK POWDER COAT

- » 3-piece modular design ships parcel post - not LTL
- » 2" tube full wraparound wings provides superior strength and protection
- » Full punch plate grille delivers total front-end protection
- » 1-1/4" tube wing supports enhance structural rigidity
- » Heavy duty 2 3/4" wide upright rubber strips give an added barrier of protection
- » Parking sensor re-location kit available (sold separately)
- » Mount kit and hardware included for a complete professional installation

FINISH: Black Powder Coat FINISH: Polished
 MATERIAL: E-Coated Steel MATERIAL: 304 Stainless Steel
 WARRANTY: 3-Year WARRANTY: Lifetime

**INNOVATIVE 3-PIECE DESIGN
 DEVELOPED AND PROVEN ON EMERGENCY
 RESPONDER VEHICLES FOR MAXIMUM STRENGTH**



**3-PIECE
 MODULAR
 DESIGN**

UP TO
**85% FREIGHT
 SAVINGS**

UP TO
**50% INVENTORY
 SPACE REDUCTION**

START	END	MAKE	MODEL	POLISHED	BLACK
2015	2022	Chevrolet	Colorado (Excl. Bison & ZR2) ^{1,2,3,4,5,6,7}	—	57-23845
2007	2013	Chevrolet	Silverado 1500 (Excl. Classic) ¹	—	57-22275
2014	2015	Chevrolet	Silverado 1500 (Excl. GMC Sierra) ^{1,2,3,4}	—	57-23688
2016	2018	Chevrolet	Silverado 1500 (Excl. W/ Sensors) ^{1,2,3,4}	57-23070	57-23075
2019	2023	Chevrolet	Silverado 1500 (Excl. ZR2 & 2019 LD) (Excl. W/ Sensors) ^{1,2,3,4,5,6,7,8}	—	57-23985
2022	2022	Chevrolet	Silverado 1500 LTD (Excl. ZR2) (Excl. W/ Sensors) ^{1,2,3,4,5,6}	—	57-23965
2015	2019	Chevrolet	Silverado 2500/3500 ^{1,2,3,4}	57-23780	57-23785
2020	2023	Chevrolet	Silverado 2500/3500 (Excl. W/ Sensors) ^{1,2,3,4}	57-23990	57-23995
2019	2019	Chevrolet	Silverado LD (Excl. W/ Sensors) ^{1,2,3,4}	57-23070	57-23075
2015	2020	Chevrolet	Suburban Tahoe (Excl. Suburban 2500HD/3500HD) ^{1,2,3,4,5,6,7,8}	—	57-23005
2021	2023	Chevrolet	Suburban Tahoe (Excl. W/ Sensors) ^{1,2,3,4,5,6}	—	57-24045
2009	2018	Dodge	Ram 1500 (Excl. Express, Rebel, Sport, Excl. ECO Diesel) (Excl. W/ Sensors) ^{1,2}	57-23540	57-23545
2010	2018	Dodge	Ram 2500/3500 ^{1,2,3,4}	57-23690	57-23695
2009	2014	Ford	F-150 (Excl. Harley Davidson & Raptor) (Excl. W/ Sensors) ^{1,2,3,4,5,6,7,8}	—	57-22505
2015	2020	Ford	F-150 (Excl. Platinum & 2017+ Raptor) (W/ Camera) ^{1,2,3,4,5,6,7,8}	—	57-23835
2015	2020	Ford	F-150 (Excl. Platinum & 2017+ Raptor) (W/ Front Camera) ^{1,2,3,4,5,6,7,8}	—	57-23935
2021	2023	Ford	F-150 (Excl. Lightning Ely) (Excl. W/ Sensors) ^{1,2,3,4,5,6,7,8}	—	57-24055
2021	2023	Ford	F-150 (Excl. Lightning EV, Platinum & Raptor) (W/ Camera) ^{1,2,3,4,5,6,7,8}	—	57-24095
2011	2016	Ford	F-250/350 Super Duty ^{1,2,3,4}	57-23070	57-23075
2017	2022	Ford	F-250/350 (Excl. Harley Davidson, Limited, & Raptor) (Excl. W/ Sensors) ^{1,2,3,4,5,6,7,8}	57-23900	57-23905
2017	2022	Ford	F-250/350 (Excl. Harley Davidson, Limited, & Raptor) (W/ Camera) ^{1,2,3,4,5,6,7,8}	—	57-23945
2019	2022	Ford	Ranger ^{1,2,3,4,5,6,7,8}	—	57-23905
2015	2023	Ford	Transit 150/250/350 (W/ Front Sensor) ¹	—	57-24055
2019	2021	GMC	Sierra 1500 (Excl. 2019 Limited) (Excl. 2022 New Body Style) (Excl. Diesel) (Excl. W/ Sensors) ^{1,2,3,4}	57-23960	57-23965
2022	2022	GMC	Sierra 1500 Limited (Excl. 2022 New Body Style) (Excl. Diesel) (Excl. W/ Sensors) ^{1,2,3,4}	57-23960	57-23965
2015	2019	GMC	Sierra 2500/3500HD ¹	57-23790	57-23795
2022	2023	Nissan	Frontier ^{1,2,3,4,5,6,7,8}	—	57-24075
2009	2018	Ram	1500 (Excl. Express, Rebel, Sport, TRX, & Warlock) (Excl. ECO Diesel) (Excl. W/ Sensors) ^{1,2}	57-23540	57-23545
2019	2023	Ram	1500 (Excl. Classic, Rebel, TRX, & Warlock) (Excl. ECO Diesel) ^{1,2,3,4,5,6,7,8}	57-23970	57-23975
2019	2023	Ram	1500 Classic (Excl. Express, Rebel, Sport, TRX, & Warlock) (Excl. ECO Diesel) (Excl. W/ Sensors) ^{1,2}	57-23540	57-23545
2010	2018	Ram	2500/3500 ^{1,2,3,4}	57-23690	57-23695
2019	2023	Ram	2500/3500 (Excl. Power Wagon) (Excl. W/ Sensors) ^{1,2,3,4,5,6,7,8}	57-24020	57-24025
2014	2023	Toyota	4Runner TRD Sport (Excl. TRD) (Excl. Limited, Nightshade, & TRD Sport) ^{1,2}	—	57-23825
2016	2023	Toyota	Tacoma (Excl. W/ Sensors) ^{1,2,3,4}	—	57-23865
2014	2021	Toyota	Tundra (Excl. W/ Sensors) ^{1,2,3,4}	57-23700	57-23705

FOOTNOTES: 1. Requires Drilling. 2. Not Compatible With Optional 16" HDX Flush Mount B-Force LED Mount Kit Part #57-0025 & 57-0035. 3. Excludes Vehicles With Forward Collision Warning Systems That Feature Grille Mounted Laser Control Sensors If Equipped. 4. Will Interfere With Adaptive Cruise (Speed) Control If Equipped. 5. Requires Removal Of Tow Hooks For Installation If Equipped. 6. Will Interfere With Parking Sensor If Equipped. 7. May Interfere With Camera If Equipped. 8. Requires Minor Trimming Of Tow Hook Rocket. 9. Requires Minor Trimming Of OEM Bumper. 10. Factory Tow Hooks Cannot Be Reused. 11. Excludes Vehicles With "Lane Departure Distance Module" If Equipped. 12. Requires Cutting The Air Dam/Bumper Valance On 2016+ Vehicles. 13. Will Interfere With Or Obstruct View Of License Plate. License Relocator Needed To Make Visible. 14. Requires Cutting Lower Bumper Trim. 15. Excludes Vehicles With OEM Skid Plate. 16. Will Interfere With Sensors. 17. Use License Plate Relocator Part #52-0055 (Sold Separately). 18. Will Interfere With Forward Collision Warning Systems If Equipped. 19. Requires Minor Trimming Of Air Dam/Bumper Valance. 20. Requires Trimming Surrounding Lower Valance Area For 2022+. 21. Excludes 2022+ Vehicles With New Front End (Non-LTD Models) With Fog Lights. 22. Excludes 2022+ Vehicles With New Front End (Non-LTD Models) With Stock Heaters. 23. Not Compatible With Optional 10" HDX Flush Mount B-Force LED Mount Kit Part #57-0035. 24. May Require Parking Sensors To Be Permanently Disabled By An Authorized GM Service Technician If Equipped. 25. Not Compatible With Optional Westin Flush Mount LED Mount Kit. 26. Excludes Vehicles With Plastic Bumpers.

SPORTSMAN X GRILLE GUARD TEXTURED BLACK

- Provides added front end protection
- Aggressive styling compliments today's larger grilles
- Heavy duty 2 3/4" wide upright rubber strips
- Removable center mesh for optional LED light
- Removable smaller mesh accommodates factory sensors
- Accepts LED flush mounted light bar - sold separately
- Exterior step plate provides easy access to engine compartment
- Removable headlight area crossbars
- Sensor relocater kit for specific Chevy and Dodge applications - sold separately

FINISH: Textured Black Powder Coat

MATERIAL: E-Coated Steel

WARRANTY: 3-Year



1 1/2" TOP TUBE

REMOVABLE
HEADLIGHT
CROSSBARS

HEAVY DUTY 2 3/4"
WIDE RUBBER STRIP

1 1/2" OUTER TUBE

DETACHABLE MESH PLATE FOR
OPTIONAL LED LIGHT BAR



OPTIONAL SPORTSMAN X
LED LIGHT KIT
PN# 40-23005



EXTERIOR STEP PLATE

1 1/2" BOTTOM TUBE



OPTIONAL SENSOR KIT
PN# 40-21015

START	END	MAKE	MODEL	TEXTURED BLACK	SENSOR KIT	PARK SENSOR HARNESS EXT.	LED LIGHT KIT	MESH PANEL
2015	2022	Chevrolet	Colorado (Excl. Blazer & ZR2) ^{1,2}	40-33845	—	—	—	40-13005
2016	2018	Chevrolet	Silverado 1500	40-33875	40-21015	40-00475	40-23005	40-13015
2019	2022	Chevrolet	Silverado 1500 (Excl. ZR2 & 2019 LD) ^{1,2,3,4,5,6,7,8,9}	40-33955	40-21005	40-00485	40-23005	—
2022	2022	Chevrolet	Silverado 1500 LTD (Excl. ZR2) ^{1,2,3,4}	40-33955	40-21005	40-00475	40-23005	—
2020	2022	Chevrolet	Silverado 2500/3500 ^{1,2}	40-33995	40-21005	—	40-23005	—
2019	2019	Chevrolet	Silverado LD	40-33875	40-21015	—	40-23005	40-13015
2016	2020	Chevrolet	Suburban/Tahoe ^{1,2,3,4,5,6,7,8,9}	40-33805	—	—	—	40-13015
2009	2018	Dodge	Ram 1500 (Excl. Rebel & Warlock) (Excl. ECO Diesel) ^{1,2,3,4,5,6,7}	40-33545	40-21025	40-00465	40-23005	40-13015
2016	2020	Ford	F-150 ^{1,2,3,4,5,6,7,8,9}	40-33835	—	—	—	40-13025
2017	2022	Ford	F-250/350 (Excl. Harley-Davidson, Limited, & Raptor) ^{1,2,3,4,5,6,7,8,9}	40-34015	—	—	—	40-13025
2014	2021	Jeep	Grand Cherokee ^{1,2,3,4,5,6,7,8,9}	40-33815	—	—	—	—
2012	2021	Nissan	Frontier ^{1,2,3,4}	40-32075	—	—	—	40-13005
2009	2018	Ram	1500 (Excl. Rebel & Warlock) (Excl. ECO Diesel) ^{1,2,3,4,5,6,7,8,9}	40-33545	40-21025	40-00465	40-23005	40-13015
2019	2023	Ram	1500 (Excl. Classic, Rebel, TRX, & Warlock) (Excl. ECO Diesel) ^{1,2,3,4,5,6,7,8,9}	40-33975	—	40-00485	40-23005	40-13015
2019	2023	Ram	1500 Classic (Excl. Rebel & Warlock) (Excl. ECO Diesel) ^{1,2,3,4,5,6,7,8,9}	40-33545	40-21025	40-00465	40-23005	40-13015
2019	2023	Ram	2500/3500 ^{1,2,3,4,5,6,7,8,9}	40-34025	—	—	40-23005	—
2014	2020	Toyota	4Runner (Excl. Limited, Nightshade, & TRD Sport) ^{1,2,3,4,5,6,7,8,9}	40-33825	—	—	—	40-13005
2016	2020	Toyota	Tacoma ^{1,2,3,4,5,6,7,8,9}	40-33855	—	—	—	40-13005
2014	2021	Toyota	Tundra ^{1,2,3,4,5,6,7,8,9}	40-33705	—	—	—	40-13025
2019	2020	All	Small Trucks (SUV W/ Sensors)	—	—	—	—	40-13035

FOOTNOTES: 1. Requires Minor Trimming Of Air Dam/Bumper Valance. 2. Requires Minor Trimming Of Tow Hook Pockets. 3. Will Interfere With Adaptive Cruise (Speed) Control If Equipped. 4. Factory Tow Hooks Cannot Be Reused. 5. Requires Removal Of Tow Hooks For Installation If Equipped. 6. Special TRD Tow Hooks Cannot Be Reused. 7. Special TRD Skid Plate Cannot Be Reused. 8. Requires Cutting The Air Dam/Bumper Valance On 2015+ Vehicles. 9. Requires Slightly Bending Aluminum A/C Line To Clear Upper Bracket. 10. Will Interfere With Sensor. 11. Will Interfere With Block Heater Plug. 12. Requires Trimming Of Tow Hook Pockets On Vehicles Without Tow Hooks. 13. Will Interfere With Forward Collision Warning Systems That Feature Grille Mounted Laser Control Sensors If Equipped. 14. Requires Cutting Lower Bumper Trim. 15. Requires Underbody Shields To Be Removed Or Modified To Install. 16. Excludes Vehicles With Lane Departure Distance Module If Equipped. 17. Requires Removal Of Skid Plate On Z71 Models If Equipped. 18. Requires Cutting The Bumper To Install Upper Support Bracket. 19. Will Interfere With Parking Sensor If Equipped. 20. May Interfere With Camera If Equipped. 21. Not Compatible With "Ford Performance By WARN® Super Duty Winch Kit". 22. Requires Trimming Surrounding Lower Valance Area For 2022+. 23. Excludes 2022+ Vehicles With New Front End (Non-LTD Models) With Fog Lights. 24. Excludes 2022+ Vehicles With New Front End (Non-LTD Models) With Block Heaters. 25. Excludes Vehicles With Plastic Bumpers.

WESTIN® GRILLE GUARDS

HDX GRILLE GUARD 304 STAINLESS STEEL / BLACK POWDER COAT

- » Mount kit and hardware included
- » 2" tube full wraparound wings
- » Full punch plate grille
- » 1-piece solid construction
- » 1 1/4" tube for support wings*
- » Heavy duty 2 3/4" wide upright rubber strips
- » Sensor Re-locator available in black or polished

*On some applications

FINISH: Polished
MATERIAL: 304 Stainless Steel
WARRANTY: Lifetime

FINISH: Black Powder Coat
MATERIAL: E-Coated Steel
WARRANTY: 3-Year

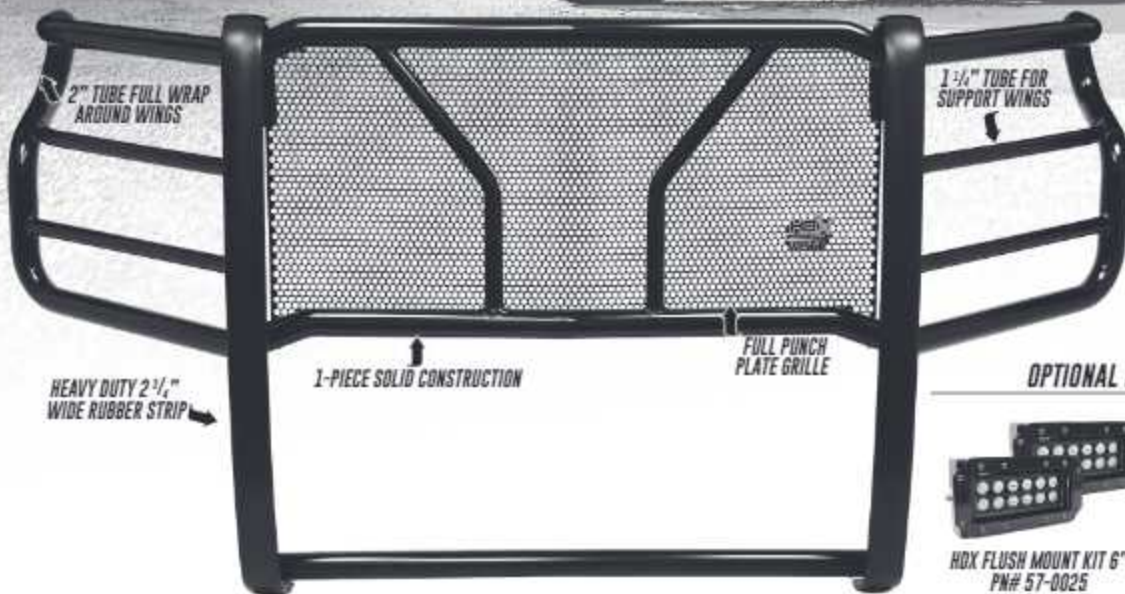

OPTIONAL PRODUCTS



HDX FLUSH MOUNT KIT 6"
PN# 57-0025



HDX FLUSH MOUNT KIT 10"
PN# 57-0035

START	END	MAKE	MODEL	POLISHED	BLACK
2015	2022	Chevrolet	Colorado (Excl. Bison & ZR2) ^{1, 1A, 1B}	-	57-2845
2007	2019	Chevrolet	Silverado 1500 (Excl. Classic) ¹	57-2270	57-2275
2014	2016	Chevrolet	Silverado 1500 (Excl. GMC Sierra) ^{1, 1A, 1B}	57-2600	57-2605
2016	2018	Chevrolet	Silverado 1500 ^{1, 1A}	57-3870	57-3875
2019	2023	Chevrolet	Silverado 1500 (Excl. ZR2 & 2019 LD) (Excl. W/ Sensors) ^{1, 1A, 1B, 1C, 1D, 1E}	57-3960	57-3965
2019	2021	Chevrolet	Silverado 1500 (Excl. ZR2 & 2019 LD) (Excl. Diesel/W/ Front Sensors) ^{1, 1A, 1B, 1C, 1D}	-	57-3965B
2022	2022	Chevrolet	Silverado 1500 LTD (Excl. ZR2) (Excl. Diesel/W/ Front Sensors) ^{1, 1A, 1B}	-	57-3965B
2007	2010	Chevrolet	Silverado 2500/3500HD (Excl. Classic) ¹	-	57-2215
2011	2014	Chevrolet	Silverado 2500/3500HD (Excl. Classic) ^{1, 1A}	57-2610	57-2615
2015	2019	Chevrolet	Silverado 2500/3500HD ^{1, 1A}	57-3780	57-3785
2020	2023	Chevrolet	Silverado 2500/3500 ^{1, 1A, 1B}	57-3990	57-3995
2020	2023	Chevrolet	Silverado 2500/3500 (Excl. Diesel/W/ Front Sensors) ^{1, 1A, 1B}	-	57-3995B
2003	2007	Chevrolet	Silverado Classic 1500 ^{1, 1A}	-	57-1175
2003	2007	Chevrolet	Silverado Classic 1500HD/3500LD	-	57-1915
2019	2019	Chevrolet	Silverado LD ^{1, 1A}	57-3870	57-3875
2015	2020	Chevrolet	Suburban Tahoe (Excl. Suburban 2500HD/3500HD) ^{1, 1A, 1B, 1C, 1D, 1E, 1F}	-	57-3205
2021	2023	Chevrolet	Suburban/Tahoe ^{1, 1A, 1B}	-	57-4045
2005	2010	Dodge	Ram 1500 (Excl. Sport)	57-1950	57-1955
2009	2018	Dodge	Ram 1500 (Excl. Express, Rebel, Sport, TRX, & Warlock) (Excl. ECU Diesel) ^{1A, 1B, 1C}	57-2540	57-2545
2005	2009	Dodge	Ram 2500/3500	57-1960	57-1965
2010	2018	Dodge	Ram 2500/3500 ^{1A, 1B}	57-2850	57-2855
2004	2008	Ford	F-150 (Excl. Harley Davidson & Raptor) ¹	57-2010	57-2015

CONTINUED ON NEXT PAGE →

HDX GRILLE GUARD CONTINUED

304 STAINLESS STEEL / BLACK POWDER COAT

START	END	MAKE	MODEL	POLISHED	BLACK
2009	2014	Ford	F-150 (Excl. Harley Davidson & Raptor) ^{1,2,3,4}	\$7-2800	\$7-2800
2015	2020	Ford	F-150 (Excl. Platinum & 2017+ Raptor)(w/O Camera) ^{1,2,3,4,5}	\$7-3850	\$7-3850
2016	2020	Ford	F-150 (Excl. Platinum & Raptor)(w/ Front Camera) ^{1,2,3,4,5}	-	\$7-3935
2021	2023	Ford	F-150 (Excl. Lightning EV, Platinum & Raptor)(w/ Camera) ^{1,2,3,4,5,6}	\$7-4065	\$7-4065
2021	2023	Ford	F-150 (Excl. Lightning EV, Platinum & Raptor)(w/ Camera) ^{1,3,4,5}	-	\$7-4085
2017	2023	Ford	F-250/350 (Excl. Harley Davidson & Raptor) ^{1,2,3,4}	\$7-3900	\$7-3905
2008	2010	Ford	F-250/350 Super Duty ^{1,2,3,4}	\$7-2360	\$7-2368
2011	2016	Ford	F-250/350 Super Duty ^{1,2,3,4}	\$7-2370	\$7-2375
2017	2023	Ford	F-250/350 (Excl. Harley Davidson, Limited, & Raptor)(w/ Front Camera) ^{1,2}	-	\$7-3945
2019	2022	Ford	Ranger ^{1,2,3,4,5,6}	-	\$7-3965
2016	2020	Ford	Transit 150/250/350 (w/O Front Sensor) ^{1,2}	-	\$7-4055
2007	2019	GMC	Sierra 1500 ^{1,2}	-	\$7-2295
2014	2016	GMC	Sierra 1500 (Excl. Chevrolet Silverado) ^{1,2,3,4,5,6}	\$7-3630	\$7-3635
2016	2018	GMC	Sierra 1500 ^{1,2,3,4}	-	\$7-3925
2019	2021	GMC	Sierra 1500 (Excl. 2019 Limited)(Excl. 2022 New Body Style)(Excl. Diesel) ^{1,2,3}	\$7-3960	\$7-3965
2022	2022	GMC	Sierra 1500 Limited (Excl. 2022 New Body Style)(Excl. Diesel) ^{1,2,3}	\$7-3960	\$7-3965
2019	2019	GMC	Sierra 1500 Limited ^{1,2,3,4}	-	\$7-3925
2007	2010	GMC	Sierra 2500/3500HD (Excl. Denali) ^{1,2,3}	-	\$7-2235
2011	2014	GMC	Sierra 2500/3500HD (Excl. Denali) ^{1,2,3}	-	\$7-2665
2016	2019	GMC	Sierra 2500/3500HD ^{1,2,3}	\$7-3790	\$7-3795
2016	2023	Nissan	Titan XD ^{1,2,3}	-	\$7-3915
2009	2018	Ram	1500 (Excl. Express, Rebel, Sport, TRX, & Warlock)(Excl. ECO Diesel) ^{1,2,3,4,5}	\$7-3540	\$7-3545
2019	2023	Ram	1500 (Excl. Classic, Rebel, TRX, & Warlock)(Excl. ECO Diesel) ^{1,2,3,4,5,6}	\$7-3970	\$7-3975
2019	2023	Ram	1500 Classic (Excl. Express, Rebel, Sport, & Warlock)(Excl. ECO Diesel) ^{1,2,3,4,5,6}	\$7-3540	\$7-3545
2010	2018	Ram	2500/3500 ^{1,2,3}	\$7-3550	\$7-3555
2019	2023	Ram	2500/3500 (Excl. Power Wagon) ^{1,2,3,4,5,6}	\$7-4020	\$7-4025
2014	2023	Toyota	4Runner SR5/Trail/TRD (Excl. Limited, Nightshade, & TRD Sport) ^{1,2}	-	\$7-3825
2016	2023	Toyota	Tacoma ^{1,2,3,4,5,6,7}	-	\$7-3835
2007	2019	Toyota	Tundra ^{1,2,3,4,5,6,7}	\$7-2220	\$7-2225
2014	2021	Toyota	Tundra ^{1,2,3,4,5,6}	\$7-3750	\$7-3755
2022	2023	Toyota	Tundra	-	\$7-4095

HDX GRILLE GUARD LED ACCESSORIES

DESCRIPTION	PART NO.
HDX Flush Mount Kit - Includes 6" LED Lights (set of 2) w/wiring harness	\$7-0025
HDX Flush Mount Kit - Includes 10" LED Lights (set of 2) w/wiring harness	\$7-0035
HDX Grille Guard LED Light Bracket for 20 or 30 inch LED bar, Stainless	\$7-0010
HDX Grille Guard LED Light Bracket for 20 or 30 inch LED bar, Black	\$7-0015

FOOTNOTES: 1. Requires Cutting The Air Dam/Bumper Valance. 2. Requires Cutting The Second Air Dam/Bumper Valance. 6. Requires Removal Of Air Scoop Mounted Behind Tow Hooks. 7. Will Interfere With Adaptive Cruise (Speed) Control If Equipped. 8. Requires Removal Of Tow Hooks For Installation If Equipped. 9. Factory Tow Hooks Can Be Reinstalled. 12. Will Interfere With Parking Sensor If Equipped. 14. Requires Drilling. 15. May Interfere With Camera If Equipped. 16. Requires Minor Trimming Of Tow Hook Pockets. 17. Requires Minor Trimming Of OEM Bumper. 19. Factory Tow Hooks Cannot Be Reused. 20. Excludes Vehicles With Lane Departure Distance Module If Equipped. 21. Requires Drilling On 2004-2005 Vehicles. 22. Requires Cutting Or Removal Of The Air Dam/Bumper Valance. 23. Special TRD Skid Plate Cannot Be Reused. 24. Special TRD Tow Hooks Cannot Be Reused. 25. Requires Slight Bend To Aluminum A/C Line To Clear Upper Bracket. 26. Vehicles 2018+, Will Interfere With Function Of Toyota Safety Sense (TSS) System If Equipped. 27. Requires Removal Of Skid Plate On Z71 Models If Equipped. 28. Requires Trimming Of Tow Hook Pockets On Vehicles Without Tow Hooks. 29. Requires Cutting The Air Dam/Bumper Valance On 2016+ Vehicles. 30. Will Interfere With Block Heater Plug. 32. Will Interfere With Or Obstruct View Of License Plate. License Relocator Needed To Make Visible. 34. Requires Cutting Lower Bumper Trim. 35. Excludes Vehicles With OEM Skid Plate. 36. Will Interfere With Sensors. 37. Not compatible with "Ford Performance by WARN® Super Duty Winch Kit". 38. Use License Plate Relocator Part # 32-0055 (Sold Separately). 39. Will Interfere With Forward Collision Warning Systems If Equipped. 40. Will Interfere With Cruise Control. 209. Requires Trimming Surrounding Lower Valance Area For 2022+. 218. Excludes 2022+ Vehicles With New Front End (Non-LTD Models) With Fog Lights. 219. Excludes 2022+ Vehicles With New Front End (Non-LTD Models) With Block Heaters. 241. Excludes Vehicles With Plastic Bumpers.



WESTIN® GRILLE GUARDS

HDX WINCH MOUNT GRILLE GUARD 304 STAINLESS STEEL / BLACK POWDER COAT

- ▶ Mount kit included
- ▶ 1-piece welded uprights
- ▶ 2" tube full wraparound wings
- ▶ Heavy duty tray brackets mount directly to the vehicle frame
- ▶ Full punch plate grille
- ▶ Winch trays tested to a minimum straight line pull of 16,500 lbs
- ▶ Fits most medium frame 8,000 - 12,500 lbs winches (up to 10 1/4" tall)

FINISH: Polished
MATERIAL: 304 Stainless Steel
WARRANTY: Lifetime

FINISH: Black Powder Coat
MATERIAL: E-Coated Steel
WARRANTY: 3-Year



2" TUBE FULL WRAP
AROUND WINGS

OPTIONAL PRODUCTS



SX 10
PN# 1710200



SX 12SR
PN# 1712201



HDX FLUSH MOUNT KIT 6"
PN# 57-0025

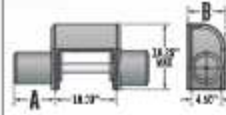

WINCH
DIMENSIONS

START	END	MAKE	MODEL	MAXIMUM WINCH DIMENSIONS		POLISHED	BLACK	FACEPLATE
				A	B			
2007	2010	Chevrolet	Silverado 1500 (Excl. Classic) ^{1,4,6}	6.5"	6.75"	—	57-92275	46-70060
2014	2016	Chevrolet	Silverado 1500 ^{4,6,7,10,11}	6.5"	6.75"	—	57-92685	46-70060
2016	2018	Chevrolet	Silverado 1500 ^{4,6,7,10}	6.5"	6.75"	57-93870	57-93873	46-70060
2019	2023	Chevrolet	Silverado 1500 (Excl. ZR2 & 2019 LD)(Excl. Diesel) ^{4,6,7,10,11,12,13}	6.5"	6.75"	—	57-92955	46-70060
2022	2022	Chevrolet	Silverado 1500 LTD (Excl. ZR2)(Excl. Diesel) ^{4,6,7,10,11,12,13}	6.5"	6.75"	—	57-92955	46-70060
2016	2019	Chevrolet	Silverado 2500/3500 ^{4,6,7,10}	6.5"	6.75"	—	57-92705	46-70060
2020	2023	Chevrolet	Silverado 2500/3500 ^{4,6,7,10,11,12,13}	6.5"	6.75"	—	57-92995	46-70060
2019	2019	Chevrolet	Silverado LD ^{4,6,7,10}	6.5"	6.75"	57-92870	57-92875	46-70060
2016	2020	Chevrolet	Suburban/Tahoe ^{4,6,7,10,11,12,13,14}	6.5"	6.75"	—	57-93005	—
2021	2023	Chevrolet	Suburban/Tahoe ^{4,6,7,10,11,12,13}	7.5"	6.5"	—	57-94045	—
2009	2018	Dodge	Ram 1500 (Excl. Rebel & Warlock) ^{1,4,6,10}	6.6"	6.4"	—	57-92645	—
2010	2018	Dodge	Ram 2500/3500 ^{1,4,6,10}	6.5"	6.75"	—	57-92555	46-70100
2009	2014	Ford	F-150 (Excl. Harley Davidson & Raptor) ^{1,2,4,6,7,10,11,12,13}	7.0"	6.5"	—	57-92505	46-70150
2016	2020	Ford	F-150 XL/SELV (Excl. Platinum & 2017+ Raptor) ^{1,2,4,6,7,10,11,12,13}	7.0"	6.5"	—	57-92835	46-70150
2021	2023	Ford	F-150 (Excl. Platinum, Raptor, & 2022+ Lightning EV)(Excl. W/ Sensors) ^{4,6,7,10,11,12,13,14,15}	7.0"	6.5"	—	57-94065	—
2020	2022	Ford	F-250/350 ^{1,4,6,7,10,11,12,13}	7.0"	6.5"	—	57-94015	46-70150
2011	2016	Ford	F-250/350 Super Duty ^{4,6,10}	6.5"	7.1"	—	57-92375	—
2017	2019	Ford	F-250/350 Super Duty (Excl. Harley Davidson & Raptor) ^{1,2,4,6,7,10,11,12,13}	7.0"	6.5"	—	57-93905	—
2009	2018	Ram	1500 (Excl. Rebel & Warlock) ^{1,4,6,10}	6.6"	6.4"	—	57-92645	—
2019	2023	Ram	1500 (Excl. Classic, Rebel, TRX, & Warlock)(Excl. ECO Diesel) ^{1,4,6,10}	6.5"	7.1"	—	57-92975	—
2019	2020	Ram	1500 Classic (Excl. Rebel & Warlock) ^{1,4,6,10}	6.6"	6.4"	—	57-92645	—
2010	2016	Ram	2500/3500 ^{1,4,6,10}	6.5"	6.75"	—	57-92555	46-70100
2019	2020	Ram	2500/3500 ^{4,6,7,10,11,12,13}	—	—	—	57-94025	—
2014	2021	Toyota	Tundra ^{1,4,6,10}	7.0"	6.5"	—	57-92705	—

FOOTNOTES: 1. Requires Trimming Lower Grille. 2. Requires Cutting The Air Dam/Bumper Valance. 5. Requires Drilling. 6. Requires Minor Trimming On 2010-2013 Models. 7. Requires Cutting Or Removal Of The Air Dam/Bumper Valance On Vehicles Without Tow Hooks. 8. Will Interfere With Adaptive Cruise (Speed) Control If Equipped. 9. Factory Tow Hooks Cannot Be Reused. 10. Requires Minor Trimming Of Tow Hook Pockets. 11. Will Interfere With Parking Sensor If Equipped. 12. May Interfere With Camera If Equipped. 13. Will Partially Block Airflow To Intercooler On EcoBoost Vehicles. 15. Requires Minor Trimming Of OEM Bumper. 17. Excludes Vehicles With Lane Departure Distance Module If Equipped. 18. Vehicles 2018+ Will Interfere With Function Of Toyota Safety Sense (TSS) System If Equipped. 19. Requires Removal Of Skid Plate On Z71 Models If Equipped. 20. Requires Trimming Center Panel Of Bumper. 21. Will Interfere With Block Heater Plug. 23. Excludes Vehicles With Skid Plate. 24. Will Interfere With Or Obstruct View Of License Plate. License Relocator Needed To Make Visible. 26. Not Compatible With *Ford Performance By *WARN® Super Duty Winch Kit#. 27. Requires Cutting Or Removing The Air Dam/Bumper Valance. 28. Requires Removing Electric Air Dam/Bumper Valance. 29. Not Compatible With Optional 6" & 10" HDX Flush Mount B-Force LED Mount Kit Part# 57-0025 & 57-0035. 30. Will Interfere With Forward Collision Warning Systems That Feature Grille Mounted Laser Control Sensors If Equipped. 224. Not Compatible With Optional 10" HDX Flush Mount B-Force LED Mount Kit Part# 57-0035. 226. May Require Parking Sensors To Be Permanently Disabled By An Authorized GM Service Technician If Equipped. 241. Excludes Vehicles With Plastic Bumpers.

SPORTSMAN GRILLE GUARD

304 STAINLESS STEEL / BLACK POWDER COAT

- ▶ Mount kit and hardware included
- ▶ 1-piece solid construction
- ▶ Uprights include 1 1/2" rubber strips
- ▶ Single or double hood bar (varies by application)
- ▶ Removable headlight area cross bars
- ▶ Mount up to 4 auxiliary lights across center bar
- ▶ Sensor Re-locator available in black or polished

FINISH: Polished
MATERIAL: 304 Stainless Steel
WARRANTY: Lifetime

FINISH: Black Powder Coat
MATERIAL: Steel
WARRANTY: 3-Year



START	END	MAKE	MODEL	HOOD BAR	POLISHED	BLACK
2007	2013	Cadillac	Escalade EXT/ESV (Excl. Platinum)	Single	—	40-2133
2003	2008	Chevrolet	Avalanche 1500 (w/o Cladding)	Single	—	40-1173
2007	2013	Chevrolet	Avalanche 1500	Single	45-2110	40-2113
1992	1994	Chevrolet	Bazer (Full Size)	Single	—	40-3039
1998	1998	Chevrolet	C/K Series 1500/2500LD (Excl. Renegade)	Double	—	40-3085
1988	2000	Chevrolet	C/K Series 2500/3500HD (Excl. 99-03 Silverado 2500LD) (Excl. Renegade)	Double	—	40-3035
2004	2012	Chevrolet	Colorado 24 WD ^{1,2,3,4,5}	Single	—	40-1515
2016	2022	Chevrolet	Colorado 24 WD (Excl. Bison & ZR2) ^{5,6,7}	Double	—	40-3446
2003	2007	Chevrolet	Silverado "Classic" 1500LD ^{1,2,3,4}	Double	—	40-1173
2003	2007	Chevrolet	Silverado "Classic" 2500/3500HD ^{1,2,3,4,5,6,7}	Single	—	40-1245
2007	2013	Chevrolet	Silverado 1500 (Excl. 2007 Classic)	Double	45-2270	40-2073
2014	2016	Chevrolet	Silverado 1500 ^{1,2,3,4,5,6,7}	Double	—	40-3605
2016	2019	Chevrolet	Silverado 1500 ^{1,2,3,4,5,6,7}	Double	—	40-3873
2019	2023	Chevrolet	Silverado 1500 (Excl. 2019 LD) (Excl. W/ Sensors) ^{1,2,3,4,5,6,7,8,9,10,11,12,13,14,15,16,17,18,19,20,21,22,23,24}	Double	—	40-3955
1999	2002	Chevrolet	Silverado 1500 LD ^{1,2,3,4,5,6,7}	Single	—	40-3105
2019	2019	Chevrolet	Silverado LD ^{1,2,3,4,5,6,7}	Double	—	40-3873
1992	1999	Chevrolet	Suburban	Single	—	40-0085
2000	2008	Chevrolet	Suburban ¹	Single	—	40-0185
2007	2014	Chevrolet	Suburban 1500 (Excl. Hybrid)	Single	45-2110	40-2115
1995	1999	Chevrolet	Tahoe	Single	—	40-3035
2000	2008	Chevrolet	Tahoe 1500 ¹	Single	—	40-0185
2007	2014	Chevrolet	Tahoe 1500 (Excl. Hybrid)	Single	45-2110	40-2115
2015	2020	Chevrolet	Tahoe ^{1,2,3,4,5,6,7,8,9,10,11,12,13,14,15,16,17,18,19,20,21,22,23,24,25,26,27,28,29,30,31,32,33,34,35,36,37,38,39,40,41,42,43,44,45,46,47,48,49,50,51,52,53,54,55,56,57,58,59,60,61,62,63,64,65,66,67,68,69,70,71,72,73,74,75,76,77,78,79,80,81,82,83,84,85,86,87,88,89,90,91,92,93,94,95,96,97,98,99,100,101,102,103,104,105,106,107,108,109,110,111,112,113,114,115,116,117,118,119,120,121,122,123,124,125,126,127,128,129,130,131,132,133,134,135,136,137,138,139,140,141,142,143,144,145,146,147,148,149,150,151,152,153,154,155,156,157,158,159,160,161,162,163,164,165,166,167,168,169,170,171,172,173,174,175,176,177,178,179,180,181,182,183,184,185,186,187,188,189,190,191,192,193,194,195,196,197,198,199,200,201,202,203,204,205,206,207,208,209,210,211,212,213,214,215,216,217,218,219,220,221,222,223,224,225,226,227,228,229,230,231,232,233,234,235,236,237,238,239,240,241,242,243,244,245,246,247,248,249,250,251,252,253,254,255,256,257,258,259,260,261,262,263,264,265,266,267,268,269,270,271,272,273,274,275,276,277,278,279,280,281,282,283,284,285,286,287,288,289,290,291,292,293,294,295,296,297,298,299,300,301,302,303,304,305,306,307,308,309,310,311,312,313,314,315,316,317,318,319,320,321,322,323,324,325,326,327,328,329,330,331,332,333,334,335,336,337,338,339,340,341,342,343,344,345,346,347,348,349,350,351,352,353,354,355,356,357,358,359,360,361,362,363,364,365,366,367,368,369,370,371,372,373,374,375,376,377,378,379,380,381,382,383,384,385,386,387,388,389,390,391,392,393,394,395,396,397,398,399,400,401,402,403,404,405,406,407,408,409,410,411,412,413,414,415,416,417,418,419,420,421,422,423,424,425,426,427,428,429,430,431,432,433,434,435,436,437,438,439,440,441,442,443,444,445,446,447,448,449,450,451,452,453,454,455,456,457,458,459,460,461,462,463,464,465,466,467,468,469,470,471,472,473,474,475,476,477,478,479,480,481,482,483,484,485,486,487,488,489,490,491,492,493,494,495,496,497,498,499,500,501,502,503,504,505,506,507,508,509,510,511,512,513,514,515,516,517,518,519,520,521,522,523,524,525,526,527,528,529,530,531,532,533,534,535,536,537,538,539,540,541,542,543,544,545,546,547,548,549,550,551,552,553,554,555,556,557,558,559,560,561,562,563,564,565,566,567,568,569,570,571,572,573,574,575,576,577,578,579,580,581,582,583,584,585,586,587,588,589,590,591,592,593,594,595,596,597,598,599,600,601,602,603,604,605,606,607,608,609,610,611,612,613,614,615,616,617,618,619,620,621,622,623,624,625,626,627,628,629,630,631,632,633,634,635,636,637,638,639,640,641,642,643,644,645,646,647,648,649,650,651,652,653,654,655,656,657,658,659,660,661,662,663,664,665,666,667,668,669,670,671,672,673,674,675,676,677,678,679,680,681,682,683,684,685,686,687,688,689,690,691,692,693,694,695,696,697,698,699,700,701,702,703,704,705,706,707,708,709,710,711,712,713,714,715,716,717,718,719,720,721,722,723,724,725,726,727,728,729,730,731,732,733,734,735,736,737,738,739,740,741,742,743,744,745,746,747,748,749,750,751,752,753,754,755,756,757,758,759,760,761,762,763,764,765,766,767,768,769,770,771,772,773,774,775,776,777,778,779,780,781,782,783,784,785,786,787,788,789,790,791,792,793,794,795,796,797,798,799,800,801,802,803,804,805,806,807,808,809,810,811,812,813,814,815,816,817,818,819,820,821,822,823,824,825,826,827,828,829,830,831,832,833,834,835,836,837,838,839,840,841,842,843,844,845,846,847,848,849,850,851,852,853,854,855,856,857,858,859,860,861,862,863,864,865,866,867,868,869,870,871,872,873,874,875,876,877,878,879,880,881,882,883,884,885,886,887,888,889,890,891,892,893,894,895,896,897,898,899,900,901,902,903,904,905,906,907,908,909,910,911,912,913,914,915,916,917,918,919,920,921,922,923,924,925,926,927,928,929,930,931,932,933,934,935,936,937,938,939,940,941,942,943,944,945,946,947,948,949,950,951,952,953,954,955,956,957,958,959,960,961,962,963,964,965,966,967,968,969,970,971,972,973,974,975,976,977,978,979,980,981,982,983,984,985,986,987,988,989,990,991,992,993,994,995,996,997,998,999,1000}	Double	—	40-3895
1997	2004	Dodge	Dakota (Excl. 2003 Sold in 2002) ^{1,2,3,4,5,6,7,8,9,10,11,12,13,14,15,16,17,18,19,20,21,22,23,24,25,26,27,28,29,30,31,32,33,34,35,36,37,38,39,40,41,42,43,44,45,46,47,48,49,50,51,52,53,54,55,56,57,58,59,60,61,62,63,64,65,66,67,68,69,70,71,72,73,74,75,76,77,78,79,80,81,82,83,84,85,86,87,88,89,90,91,92,93,94,95,96,97,98,99,100,101,102,103,104,105,106,107,108,109,110,111,112,113,114,115,116,117,118,119,120,121,122,123,124,125,126,127,128,129,130,131,132,133,134,135,136,137,138,139,140,141,142,143,144,145,146,147,148,149,150,151,152,153,154,155,156,157,158,159,160,161,162,163,164,165,166,167,168,169,170,171,172,173,174,175,176,177,178,179,180,181,182,183,184,185,186,187,188,189,190,191,192,193,194,195,196,197,198,199,200,201,202,203,204,205,206,207,208,209,210,211,212,213,214,215,216,217,218,219,220,221,222,223,224,225,226,227,228,229,230,231,232,233,234,235,236,237,238,239,240,241,242,243,244,245,246,247,248,249,250,251,252,253,254,255,256,257,258,259,260,261,262,263,264,265,266,267,268,269,270,271,272,273,274,275,276,277,278,279,280,281,282,283,284,285,286,287,288,289,290,291,292,293,294,295,296,297,298,299,300,301,302,303,304,305,306,307,308,309,310,311,312,313,314,315,316,317,318,319,320,321,322,323,324,325,326,327,328,329,330,331,332,333,334,335,336,337,338,339,340,341,342,343,344,345,346,347,348,349,350,351,352,353,354,355,356,357,358,359,360,361,362,363,364,365,366,367,368,369,370,371,372,373,374,375,376,377,378,379,380,381,382,383,384,385,386,387,388,389,390,391,392,393,394,395,396,397,398,399,400,401,402,403,404,405,406,407,408,409,410,411,412,413,414,415,416,417,418,419,420,421,422,423,424,425,426,427,428,429,430,431,432,433,434,435,436,437,438,439,440,441,442,443,444,445,446,447,448,449,450,451,452,453,454,455,456,457,458,459,460,461,462,463,464,465,466,467,468,469,470,471,472,473,474,475,476,477,478,479,480,481,482,483,484,485,486,487,488,489,490,491,492,493,494,495,496,497,498,499,500,501,502,503,504,505,506,507,508,509,510,511,512,513,514,515,516,517,518,519,520,521,522,523,524,525,526,527,528,529,530,531,532,533,534,535,536,537,538,539,540,541,542,543,544,545,546,547,548,549,550,551,552,553,554,555,556,557,558,559,560,561,562,563,564,565,566,567,568,569,570,571,572,573,574,575,576,577,578,579,580,581,582,583,584,585,586,587,588,589,590,591,592,593,594,595,596,597,598,599,600,601,602,603,604,605,606,607,608,609,610,611,612,613,614,615,616,617,618,619,620,621,622,623,624,625,626,627,628,629,630,631,632,633,634,635,636,637,638,639,640,641,642,643,644,645,646,647,648,649,650,651,652,653,654,655,656,657,658,659,660,661,662,663,664,665,666,667,668,669,670,671,672,673,674,675,676,677,678,679,680,681,682,683,684,685,686,687,688,689,690,691,692,693,694,695,696,697,698,699,700,701,702,703,704,705,706,707,708,709,710,711,712,713,714,715,716,717,718,719,720,721,722,723,724,725,726,727,728,729,730,731,732,733,734,735,736,737,738,739,740,741,742,743,744,745,746,747,748,749,750,751,752,753,754,755,756,757,758,759,760,761,762,763,764,765,766,767,768,769,770,771,772,773,774,775,776,777,778,779,780,781,782,783,784,785,786,787,788,789,790,791,792,793,794,795,796,797,798,799,800,801,802,803,804,805,806,807,808,809,810,811,812,813,814,815,816,817,818,819,820,821,822,823,824,825,826,827,828,829,830,831,832,833,834,835,836,837,838,839,840,841,842,843,844,845,846,847,848,849,850,851,852,853,854,855,856,857,858,859,860,861,862,863,864,865,866,867,868,869,870,871,872,873,874,875,876,877,878,879,880,881,882,883,884,885,886,887,888,889,890,891,892,893,894,895,896,897,898,899,900,901,902,903,904,905,906,907,908,909,910,911,912,913,914,915,916,917,918,919,920,921,922,923,924,925,926,927,928,929,930,931,932,933,934,935,936,937,938,939,940,941,942,943,944,945,946,947,948,949,950,951,952,953,954,955,956,957,958,959,960,961,962,963,964,965,966,967,968,969,970,971,972,973,974,975,976,977,978,979,980,981,982,983,984,985,986,987,988,989,990,991,992,993,994,995,996,997,998,999,1000}	Single	—	40-0145
2005	2011	Dodge	Dakota ^{1,2,3,4,5,6,7,8,9,10,11,12,13,14,15,16,17,18,19,20,21,22,23,24,25,26,27,28,29,30,31,32,33,34,35,36,37,38,39,40,41,42,43,44,45,46,47,48,49,50,51,52,53,54,55,56,57,58,59,60,61,62,63,64,65,66,67,68,69,70,71,72,73,74,75,76,77,78,79,80,81,82,83,84,85,86,87,88,89,90,91,92,93,94,95,96,97,98,99,100}	Single	—	40-1665
1993	2003	Dodge	Durango ^{1,2,3,4,5,6,7,8,9,10,11,12,13,14,15,16,17,18,19,20,21,22,23,24,25,26,27,28,29,30,31,32,33,34,35,36,37,38,39,40,41,42,43,44,45,46,47,48,49,50,51,52,53,54,55,56,57,58,59,60,61,62,63,64,65,66,67,68,69,70,71,72,73,74,75,76,77,78,79,80,81,82,83,84,85,86,87,88,89,90,91,92,93,94,95,96,97,98,99,100}	Single	—	40-0145
2002	2008	Dodge	Ram 1500 (Incl. Sport) (Excl. Daytona, Power Wagon, Rumble Bee, 5RT-10, & Thunder Road) ^{1,2,3,4,5,6,7,8,9,10,11,12,13,14,15,16,17,18,19,20,21,22,23,24,25,26,27,28,29,30,31,32,33,34,35,36,37,38,39,40,41,42,43,44,45,46,47,48,49,50,51,52,53,54,55,56,57,58,59,60,61,62,63,64,65,66,67,68,69,70,71,72,73,74,75,76,77,78,79,80,81,82,83,84,85,86,87,88,89,90,91,92,93,94,95,96,97,98,99,100}	Single	—	40-1233
2006	2008	Dodge	Ram 1500 ^{1,2,3,4,5,6,7,8,9,10,11,12,13,14,15,16,17,18,19,20,21,22,23,24,25,26,27,28,29,30,31,32,33,34,35,36,37,38,39,40,41,42,43,44,45,46,47,48,49,50,51,52,53,54,55,56,57,58,59,60,61,62,63,64,65,66,67,68,69,70,71,72,73,74,75,76,77,78,79,80,81,82,83,84,85,86,87,88,89,90,91,92,93,94,95,96,97,98,99,100}	Single	—	40-1955
2009	2018	Dodge	Ram 1500 (Excl. Rebel) (Excl. Eco Diesel) ^{1,2,3,4,5,6,7,8,9,10,11,12,13,14,15,16,17,18,19,20,21,22,23,24,25,26,27,28,29,30,31,32,33,34,35,36,37,38,39,40,41,42,43,44,45,46,47,48,49,50,51,52,53,54,55,56,57,58,59,60,61,62,63,64,65,66,67,68,69,70,71,72,73,74,75,76,77,78,79,80,81,82,83,84,85,86,87,88,89,90,91,92,93,94,95,96,97,98,99,100}	Double	—	40-3545
2003	2008	Dodge	Ram 2500/3500 (Incl. Sport) (Excl. Daytona, Power Wagon, Rumble Bee, 5RT-10, & Thunder Road) ^{1,2,3,4,5,6,7,8,9,10,11,12,13,14,15,16,17,18,19,20,21,22,23}			

SPORTSMAN GRILLE GUARD *CONTINUED*

304 STAINLESS STEEL / BLACK POWDER COAT

START	END	MAKE	MODEL	HOOD BAR	POLISHED	BLACK
2001	2003	Ford	F-150 SuperCrew 4WD	Single	—	40-0245
1997	2004	Ford	F-150/250LD 4WD (2004 Heritage Only) ¹	Single	—	40-0245
2011	2016	Ford	F-250/350 Super Duty ^{14, 24}	Double	—	40-2379
1999	2004	Ford	F-250/350/450/550 Super Duty (Excl. Harley Davidson)	Single	—	40-0225
2005	2007	Ford	F-250/350/450/550 Super Duty	Double	—	40-1645
2001	2008	Ford	Ranger/Ranger Edge ¹⁴	Double	—	40-0885
2006	2011	Ford	Ranger (Excl. STX) ¹⁴	Single	—	40-2055
2019	2022	Ford	Ranger ^{14, 24, 34, 44, 54, 64, 74}	Single	—	40-3985
1993	1999	GMC	C/K Series 1500 ¹	Single	—	40-0005
1998	2006	GMC	C/K Series 2500/3500HD (Excl. 99-00 Chevrolet Silverado 2500LD) ¹	Double	—	40-0005
2004	2012	GMC	Canyon 2.4 WD ^{1, 2, 3, 4}	Single	—	40-1515
1992	1994	GMC	Jimmy (Full Size)	Single	—	40-0085
2003	2007	GMC	Sierra Classic ¹ 2500/3500HD ^{1, 11}	Single	—	40-1265
1999	2002	GMC	Sierra 1500LD ¹	Single	—	40-0335
2003	2007	GMC	Sierra Classic 1500LD ^{1, 11}	Single	—	40-1225
1992	1999	GMC	Yukon (Excl. Denali)	Single	—	40-0095
2000	2006	GMC	Yukon/Yukon XL (Excl. Denali) ¹	Single	—	40-0335
2007	2014	GMC	Yukon/Yukon XL 1500 (Excl. Hybrid)	Single	—	40-2135
2006	2010	Hummer	H3	Single	—	40-1925
2006	2008	Isuzu	i-Series ⁵	Single	—	40-1815
2014	2021	Jeep	Grand Cherokee ^{1, 2, 3, 4}	Double	45-3810	40-3815
2001	2010	Mazda	B-Series Pickup (Excl. Dual Sport)	Single	—	40-0605
2004	2015	Nissan	Armada 2.4WD ^{1, 2, 3, 4, 5, 6}	Single	—	40-1485
2008	2011	Nissan	Frontier ^{1, 11}	Single	—	40-2065
2012	2021	Nissan	Frontier ^{1, 11}	Double	45-2070	40-2075
2006	2007	Nissan	Pathfinder ^{1, 11}	Single	—	40-2065
2004	2015	Nissan	Titan King/Crew Cab ^{1, 2, 3}	Single	—	40-1485
2009	2016	Ram	1500 (Excl. Rebel) (Excl. ECO Diesel) ^{5, 11, 14, 15, 16, 17}	Double	—	40-3545
2016	2023	Ram	1500 (Excl. Classic, Rebel, TRX, & Warlock) (Excl. ECO Diesel) ^{1, 11, 14, 15, 16}	Single	—	40-3975
2019	2023	Ram	1500 Classic (Excl. Rebel & Warlock) (Excl. ECO Diesel) ^{1, 11, 14, 15, 16, 17}	Double	—	40-3545
2010	2016	Ram	2500/3500 ^{1, 2, 3, 4}	Double	—	40-3555
2014	2023	Toyota	4Runner (Excl. Limited, Nightshade, & TRD Sport) ^{11, 14, 15}	Double	—	40-3825
2006	2014	Toyota	FJ Cruiser ¹	Double	—	40-2215
1998	2004	Toyota	Tacoma ¹¹	Double	—	40-0905
2005	2015	Toyota	Tacoma ^{11, 14}	Double	—	40-1605
2016	2023	Toyota	Tacoma ^{11, 14, 15, 16}	Double	45-3880	40-3885
2003	2008	Toyota	Tundra (Excl. Double Cab)	Single	—	40-1365
2014	2021	Toyota	Tundra ^{11, 14, 15}	Double	45-3700	40-3705

FOOTNOTES:

1. See Separate Listings For 1999-2004 Silverado & Sierra Body Styles. 3. Requires Minor Cutting Of Air Dam/Bumper Valance On Vehicles Without Tow Hooks. 5. Requires Cutting The Air Dam/Bumper Valance. 6. Requires Removal Of Bumper Cover To Install Mounting Brackets. 7. Requires Removal Of Grille To Install Mounting Brackets. 12. Requires Enlarging The Frame Hole With A .5 Inch Drill Bit On 1996 Vehicles. 13. Will Be Limited Access To Tow Hooks After Installation. 14. Requires Underbody Shields To Be Removed Or Modified To Install. 15. Minor Trimming Of Air Dam/Bumper Valance May Be Required. 17. Requires Removal Of Tow Hooks For Installation If Equipped. 19. Requires Removal Of Skid Plate If Equipped. 22. Fits Vehicles With Chrome Bumpers Only. 24. Excludes 2WD 5-Cylinder Vehicles. 28. Excludes Vehicles With Adaptive Cruise (Speed) Control If Equipped. 28. Excludes Vehicles With Parking Sonar/Aid System. 32. Will Interfere With Parking Sensor If Equipped. 33. May Interfere With Camera If Equipped. 36. Factory Tow Hooks Cannot Be Reused. 37. Requires Minor Trimming Of Tow Hook Pockets. 38. Excludes Vehicles With "Lane Departure Distance Module" If Equipped. 38. Special TRD Tow Hooks Cannot Be Reused. 40. Special TRD Skid Plate Cannot Be Reused. 41. Requires Slight Bend To Aluminum A/C Line To Clear Upper Bracket. 43. Requires Cutting The Air Dam/Bumper Valance On 2016+ Vehicles. 44. Will Interfere With Block Heater Plug. 45. Will Interfere With Or Obstruct View Of License Plate. License Relocator Needed To Make Visible. 46. Excludes Vehicles With OEM Skid Plate. 47. Includes Replacement Fasteners To Re-Attach Cover. 48. Compatible With Maximum 9" Lights. 49. Excludes 4WD V8 Vehicles With Off-Road Package. 50. Excludes Vehicles With Forward Collision Warning Systems That Feature Grille Mounted Laser Control Sensors If Equipped. 51. Use License Plate Relocator Part# 32-0055 (Sold Separately). 209. Requires Trimming Surrounding Lower Valance Area For 2022+. 218. Excludes 2022+ Vehicles With New Front End (Non-LTD Models) With Fog Lights. 219. Excludes 2022+ Vehicles With New Front End (Non-LTD Models) With Block Heaters. 241. Excludes Vehicles With Plastic Bumpers.

HDX B-FORCE FLUSH MOUNT LED KIT

UPGRADE YOUR HDX OR HDX WINCH MOUNT GRILLE GUARD

- » Installs onto Westin HDX Grille Guard punch plate
- » Kit Includes: (2) B-FORCE double row LED light bars, (2) flush mount faceplates, (2) adjustable slider brackets, (1) dual connecting wiring harness and mounting hardware, pigtail connector
- » 6063 extruded aluminum housing with die-cast ends

FINISH: Black Powder Coat
 MATERIAL: Steel
 WARRANTY: 3-Year
 LED WARRANTY: Limited Lifetime

- » 3W LED chips
- » Available in flood or combo beam
- » Choose mounting method: direct bolt-on or cut-out punch plate installation
- » Registered U.S. Patent

**B-FORCE
HDX FLUSH MOUNT KIT 10"****B-FORCE
HDX FLUSH MOUNT KIT 6"****HDX B-FORCE FLUSH MOUNT LED KIT**

HDX Flush Mount Kit - Includes 6" LED Lights (set of 2) wiring harness
 HDX Flush Mount Kit - Includes 10" LED Lights (set of 2) wiring harness

PART NO.

57-0029

57-0035

MAX WINCH TRAY/BASE UNIT

BLACK POWDER COAT

- » Heavy duty brackets mount directly to the vehicle frame
- » Winch trays tested to a minimum straight line pull of 16,500 lbs
- » Fits most medium frame 8,000 - 12,500 lbs winches (up to 10.14" tall)
- » Pre-drilled for quick mounting of hawse or roller fairlead
- » Optional MAX Bull Bar/Light Bar, MAX Faceplate, MAX Tow Hooks, sold separately

FINISH: Black Powder Coat
 MATERIAL: E-Coated Steel
 WARRANTY: 3-Year

**MAX WINCH TRAY MOUNTING SYSTEM**

OPTIONAL UPGRADES

MAX BULL BAR/LIGHT BAR

- » Mounts directly to MAX Winch Tray
- » Made of 3" tube
- » Mount up to 3 off-road lights for most applications
- » Pre-drilled for wire management
- » No drilling required
- » Optional upgrade, sold separately

FINISH: Black Powder Coat
 MATERIAL: E-Coated Steel
 WARRANTY: 3-Year

MAX FACEPLATE

- » Mounts directly to MAX Winch Tray
- » Application specific
- » Polished stainless steel
- » Tow hook openings
- » Made of 14 gauge steel
- » Optional upgrade, sold separately

FINISH: Polished
 MATERIAL: 304 Stainless Steel
 WARRANTY: Lifetime

CONTINUED ON NEXT PAGE →

MAX WINCH TRAY MOUNTING SYSTEM CONTINUED

OPTIONAL UPGRADES

MAX TOW HOOK

- Maximum load rating of 12,000 lbs
- Sold (1) per package

FINISH: Black Powder Coat
MATERIAL: E-Coated Steel
WARRANTY: 3-Year



PN# 46-3005

LICENSE PLATE RE-LOCATOR

- Mounts directly to MAX Winch Tray
- Application specific
- Polished stainless steel
- Tow hook openings
- Made of 14 gauge steel
- Optional upgrade, sold separately

FINISH: Black Powder Coat
MATERIAL: E-Coated Steel
WARRANTY: 3-Year



PN# 46-20055 (Roller Fairlead)

PN# 46-20065 (Hawse Fairlead)

START	END	MAKE	MODEL	STRAIGHT LINE PULL CAPACITY	MAXIMUM WINCH DIMS		NO. OF LIGHTS	FACEPLATE	STAINLESS BB/LB	BLACK BB/LB	WINCH TRAY
					A	B					
2015	2023	Chevrolet	Colorado ^{1,3,4}	16,500 lbs	6.5"	6.75"	3	—	46-41600	46-41605	46-23845
2007	2013	Chevrolet	Silverado 1500 (Excl. 2007 Classic) ^{1,4,5,6}	16,500 lbs	6.5"	6.75"	3	—	46-42270	46-42275	46-22275
2014	2016	Chevrolet	Silverado 1500 ^{4,5,6}	16,500 lbs	6.5"	6.75"	3	46-70060	46-42270	46-42275	46-23685
2016	2016	Chevrolet	Silverado 1500 ^{4,5,6}	16,500 lbs	6.5"	6.75"	3	46-70060	46-42270	46-42275	46-23675
2019	2023	Chevrolet	Silverado 1500 (Excl. 2019 Silverado LD) ^{4,5,6,7,8}	16,500 lbs	6.5"	6.75"	3	46-70060	46-42270	46-42275	46-23685
2022	2022	Chevrolet	Silverado 1500 LTD ^{4,5,6,7,8}	16,500 lbs	6.5"	6.75"	3	46-70060	46-42270	46-42275	46-23685
2000	2007	Chevrolet	Silverado 1500LD Classic ⁹	16,500 lbs	6.5"	6.75"	3	—	—	46-41175	46-21175
2000	2007	Chevrolet	Silverado 2500/3500HD Classic ⁹	16,500 lbs	6.5"	6.75"	3	—	—	46-41175	46-21245
2011	2014	Chevrolet	Silverado 2500/3500HD ^{4,5,6}	16,500 lbs	6.5"	6.75"	3	46-70060	—	—	46-23715
2015	2019	Chevrolet	Silverado 2500/3500HD ^{4,5,6}	16,500 lbs	6.5"	6.75"	3	46-70060	—	—	46-23735
2020	2023	Chevrolet	Silverado 2500/3500 ^{4,5,6,7,8}	16,500 lbs	6.5"	6.75"	3	46-70060	—	—	46-23695
2019	2019	Chevrolet	Silverado LD ^{4,5,6,7,8}	16,500 lbs	6.5"	6.75"	3	46-70060	46-42270	46-42275	46-23875
2016	2020	Chevrolet	Suburban/Tahoe ^{4,5,6,7}	16,500 lbs	6.5"	6.75"	3	—	46-42270	46-42275	46-23805
2021	2023	Chevrolet	Suburban/Tahoe ^{4,5,6,7}	16,500 lbs	6.5"	6.75"	3	—	—	—	46-24045
2009	2016	Dodge	Ram 1500 (Excl. Rebel & Warlock) (Excl. ECO Diesel) ^{4,5,6,7}	16,500 lbs	6.6"	6.4"	3	—	46-43750	46-43755	46-23755
2010	2016	Dodge	Ram 2500/3500 ⁴	16,500 lbs	6.5"	6.75"	3	46-70100	—	46-43555	46-23555
2009	2014	Ford	F-150 ^{4,5,6,7,8,9}	16,500 lbs	7.0"	6.5"	3	46-70150	46-43740	46-43745	46-23745
2015	2020	Ford	F-150 (Excl. Platinum & 2017+ Raptor) ^{4,5,6,7,8,9}	16,500 lbs	7.0"	6.5"	3	46-70150	46-43740	46-43745	46-23835
2008	2010	Ford	F-250/350/450/650 Super Duty ⁹	16,500 lbs	6.8"	7.1"	3	—	—	46-43725	46-23725
2011	2016	Ford	F-250/350/450/650 Super Duty ⁹	16,500 lbs	6.5"	7.1"	3	—	—	46-43725	46-23735
2020	2023	Ford	F-250/350 ^{4,5,6,7,8,9,10,11}	16,500 lbs	7.0"	6.5"	3	46-70150	46-43740	46-43745	46-23805
2019	2022	Ford	Ranger ^{4,5,6,7,8,9,10,11,12}	16,500 lbs	6.5"	6.75"	3	—	46-41600	46-41605	46-23935
2016	2022	GMC	Canyon ^{4,5}	16,500 lbs	6.5"	6.75"	3	—	46-41600	46-41605	46-23845
2007	2016	GMC	Sierra 1500 (Excl. 2007 Classic) ^{1,4,5}	16,500 lbs	6.5"	6.75"	3	—	46-42270	46-42275	46-22275
2014	2016	GMC	Sierra 1500 ^{4,5,6}	16,500 lbs	6.5"	6.75"	3	46-70060	46-42270	46-42275	46-23685
2007	2010	GMC	Sierra 2500/3500HD ^{4,5,6}	16,500 lbs	6.5"	6.75"	3	46-70060	—	—	46-23715
2007	2016	Jeep	Wrangler JK ^{1,3}	9,800 lbs	6.75"	7.25"	0	—	—	46-43605	—
2022	2023	Nissan	Frontier ^{1,2,3,4,5}	12,500 lbs	6.5"	6.75"	3	—	—	—	46-24075
2009	2016	Ram	1500 (Excl. Rebel & Warlock) (Excl. ECO Diesel) ^{4,5,6,7}	16,500 lbs	6.6"	6.4"	3	—	46-43750	46-43755	46-23755
2019	2023	Ram	1500 (Excl. Classic, Rebel, TRX, & Warlock) (Excl. ECO Diesel) ^{4,5}	16,500 lbs	6.5"	6.75"	2	—	—	—	46-23975
2019	2023	Ram	1500 Classic (Excl. Rebel, TRX, & Warlock) (Excl. ECO Diesel) ^{4,5,6,7}	16,500 lbs	6.6"	6.4"	3	—	46-43750	46-43755	46-23755
2010	2010	Ram	2500/3500 ⁴	16,500 lbs	6.5"	6.75"	3	46-70100	—	46-43555	46-23555
2019	2023	Ram	2500/3500 ^{4,5,6,7,8,9}	16,500 lbs	6.5"	6.75"	3	—	—	46-43555	46-24025
2005	2016	Toyota	Tacoma (Excl. 2WD Base Model) ^{1,2,3,4,5}	16,500 lbs	6.5"	6.75"	3	—	46-41600	46-41605	46-21605
2016	2023	Toyota	Tacoma ^{1,2,3,4,5,6}	16,500 lbs	6.5"	6.75"	3	—	46-41600	46-41605	46-23885
2007	2021	Toyota	Tundra ^{1,2,3,4,5}	16,500 lbs	7.0"	6.5"	3	—	—	46-42235	46-22235

FOOTNOTES: 1. Lights Mount To Winch Tray. 2. Requires Trimming Lower Bumper Grille On 2010-2015 Vehicles. 3. Will Partially Block Airflow To Intercooler On EcoBoost Vehicles. 5. Requires Removal Of The Air Dam/Bumper Valance If Equipped. 6. Requires Cutting Or Removal Of The Air Dam/Bumper Valance On Vehicles Without Tow Hooks. 7. Requires Drilling. 9. Factory Tow Hooks Cannot Be Reused. 10. Requires Minor Trimming Of Tow Hook Pockets. 12. Will Interfere With Parking Sensor If Equipped. 14. Will Interfere With Camera If Equipped. 15. Will Interfere With Adaptive Cruise (Speed) Control If Equipped. 17. Excludes Vehicles With Lane Departure Distance Module If Equipped. 18. Requires Trimming Lower Grille. 19. May Require Cutting The Air Dam/Bumper Valance. 20. Special TRD Skid Plate Cannot Be Reused. 21. Special TRD Tow Hooks Cannot Be Reused. 22. Requires Trimming Center Panel Of Bumper. 23. Will Interfere With Block Heater Plug. 25. Excludes Vehicles With Skid Plate. 26. Winch Tray Fits Superwinch Tiger Shark And Talon Winches. 27. Winch Tray With Winch Mount Grille Guard Fits Superwinch Tiger Shark Winch. 28. Will Interfere With Or Obstruct View Of License Plate. License Relocator Needed To Make Visible. 29. Compatible With Part # 46-70100, 46-43550, 46-43555. 207. Not Compatible With Intelligent Cruise Control. 208. Requires Trimming. 241. Excludes Vehicles With Plastic Bumpers.

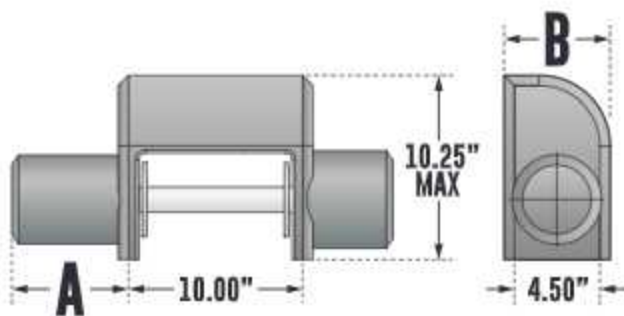

SENSOR RE-LOCATOR

304 STAINLESS STEEL / BLACK POWDER COAT



- » Hardware included
- » Re-locates factory parking sensors
- » Set of 2
- » 20 gauge pigtail and connector included
- » Mounts directly to grille guard uprights
- » Drilling required
- » Registered U.S. Patent

FINISH: Polished
MATERIAL: 304 Stainless Steel
WARRANTY: Lifetime

FINISH: Black Powder Coat
MATERIAL: E-Coated Steel
WARRANTY: 3-Year

START	END	MAKE	MODEL	POLISHED	BLACK
2014	2018	Chevrolet	Silverado 1500	45-0000S	40-0005S
2015	2019	Chevrolet	Silverado 2500/3500	45-0000S	40-0005S
2019	2019	Chevrolet	Silverado LD	45-0000S	40-0005S
2015	2020	Chevrolet	Suburban	45-0000S	40-0005S
2015	2020	Chevrolet	Tahoe	45-0000S	40-0005S
2009	2018	Dodge	Ram 1500	45-0010S	40-0015S
2010	2018	Dodge	Ram 2500/3500	45-0010S	40-0015S
2014	2018	GMC	Sierra 1500	45-0000S	40-0005S
2019	2019	GMC	Sierra 1500 Limited	45-0000S	40-0005S
2016	2019	GMC	Sierra 2500/3500	45-0000S	40-0005S
2009	2018	Ram	1500	45-0010S	40-0015S
2019	2023	Ram	1500 Classic	45-0010S	40-0015S
2010	2018	Ram	2500/3500	45-0010S	40-0015S

HDX LIGHT CLAMPS

304 STAINLESS STEEL / BLACK POWDER COAT

- » Optional Light Clamps are available, 57-0000 in stainless and 57-0005 in black, which allow post mount lights to be mounted to the cross tube and punch plate.



STAINLESS
➔ PN# 57-0000

FINISH: Polished
MATERIAL: 304 Stainless Steel
WARRANTY: Lifetime



BLACK
➔ PN# 57-0005

FINISH: Black Powder Coat
MATERIAL: E-Coated Steel
WARRANTY: 3-Year

LICENSE PLATE RE-LOCATOR

304 STAINLESS STEEL / BLACK POWDER COAT

- » Mounts directly to winch tray
- » Hinged "flip-up" system
- » Clasp closure holds license plate in place

➔ PN# 46-20065 (Hawse Fairlead)

➔ PN# 46-20055 (Roller Fairlead)

FINISH: Black Powder Coat
MATERIAL: E-Coated Steel
WARRANTY: 3-Year



CLOSE



OPEN

WESTIN | BUMPERS

	NEW! - XTS Front Bumper	73
	NEW! - Pro-Series Front Bumper	74
	NEW! - Pro-Series Rear Bumper	76
	Pro-Mod Front Bumper	77
	HDX Bandit Front Bumper	78
	HDX Bandit Rear Bumper	79
	Outlaw Front Bumper	80
	Outlaw Rear Bumper	80
	FEY Perfect Match Series Bumpers	81
	FEY Universal Series Bumpers.....	82

NEW! XTS FRONT BUMPER TEXTURED BLACK

- ▶ High strength, lightweight design
- ▶ Low profile winch mount improves air flow
- ▶ Integrated lightweight 10-gauge steel shell & 4-gauge steel winch tray provides superior strength at an affordable price
- ▶ Features 4.5" x 10" winch mount pattern
- ▶ Accommodates most winches up to 12,000 lbs. capacity
- ▶ Provides two recovery points for shackles
- ▶ Compatible with all factory sensors
- ▶ Optional skid plate (sold separately)
- ▶ Optional round bull bar or angular bull bar (sold separately)
- ▶ Hardware and mounting brackets included
- ▶ E-coated base coat provides long lasting corrosion protection
- ▶ Available in textured black finish

FINISH: Textured Black Powder Coat
MATERIAL: E-Coated Steel
WARRANTY: 3-Year



OPTIONAL PRODUCTS FOR XTS FRONT BUMPER



SX 10SR
PN# 1710201



XTS/PRO-MOD SKID PLATE
PN# 59-721255



XTS ROUND BULL BAR
PN# 59-731255

XTS ANGULAR BULL BAR
PN# 59-741255



FUSION5 SINGLE ROW LIGHT BAR
PN# 09-12232

START	END	MAKE	MODEL	TEXTURED BLACK	SKID PLATE
2021	2023	Ford	Bronco (W/ Sensor)(Excl. Bronco Sport) ^{91, 195}	59-711255	59-721255
START	END	MAKE	MODEL	ANGULAR BULL BAR	ROUND BULL BAR
2021	2023	Ford	Bronco (Excl. Bronco Sport) ^{91, 195, 220}	59-741255	59-731255

FOOTNOTES: 91. Compatible With Most Medium Frame 8000-12000lbs Winches. 195. Will Partially Block Camera View. 220. Compatible With One 20 Inch Single Row LED Light Bar.
231. Not Compatible with OEM Bumper. 232. Fits XTS Bumpers Only.

WESTIN[™] | BUMPERS

NEW! PRO-SERIES MID-WIDTH FRONT BUMPER TEXTURED BLACK

- » Low-profile design to maximize approach angles
- » Fits most 8,000-12,000 lb. synthetic rope winches
- » Constructed of 10-gauge steel for strength
- » Heavy-duty 4-gauge winch mount center section provides superior strength and easy installation
- » Compatible with hawse fairlead ONLY
- » Features large access holes for easier winch operation
- » Provides two recovery points for shackles
- » Configured to accept most single row 20" LED light bars (sold separately)
- » Available in two Bull Bar styles (round and angular)
- » Hardware and mounting brackets included
- » E-coated base coat provides long lasting corrosion protection
- » Available in textured black powder coat finish

FINISH: Textured Black Powder Coat
MATERIAL: E-Coated Steel
WARRANTY: 3-Year



SHOWN: SX 10SR
PN# 1710201
SOLD SEPARATELY



START	END	MAKE	MODEL	TEXTURED BLACK
2014	2023	Toyota	4Runner (Bumper Only) (Excl. Limited, Nightshade, TRD Sport) ^{6, 7, 10, 13, 20, 24}	58-411155
2014	2023	Toyota	4Runner (Angular Bull Bar Only) (Excl. Limited, Nightshade, TRD Sport) ^{6, 7, 10, 13, 20, 24}	58-411155AB
2014	2023	Toyota	4Runner (Bumper w/Angular Bull Bar) (Excl. Limited, Nightshade, TRD Sport) ^{6, 7, 10, 13, 20, 24}	58-411155ABK
2014	2023	Toyota	4Runner (Round Bull Bar Only) (Excl. Limited, Nightshade, TRD Sport) ^{6, 7, 10, 13, 20, 24}	58-411155RB
2014	2023	Toyota	4Runner (Bumper w/Round Bull Bar) (Excl. Limited, Nightshade, TRD Sport) ^{6, 7, 10, 13, 20, 24}	58-411155RBK
2016	2023	Toyota	Tacoma ^{6, 7, 10, 13, 20, 24}	58-411045
2016	2023	Toyota	Tacoma ^{6, 7, 10, 13, 20, 24}	58-311045
2019	2023	Mercedes-Benz	Sprinter ^{6, 7, 10, 13, 20, 24}	58-311295

FOOTNOTES: 6. Compatible With Most Medium Frame 8000-12000 lbs Winches. 7. Compatible With One 20 Inch Single Or Double Row LED Light Bar. 10. Compatible With TRD Skid Plate. 13. Requires Minor Trimming Of OEM Bumper. 14. Not Compatible With Talon Winch Series. 16. Will Interfere With Toyota Safety Sense (TSS) System If Equipped. 20. Not Compatible With Roller Fairlead. 240. May Require Recalibration Of Pre-Collision Sensor. 242. Use Cruise Control Relocator Bracket Part# 58-40035 (Sold Separately).

NEW! PRO-SERIES FRONT BUMPER / FULL-SIZED TRUCKS TEXTURED BLACK

- » Provides a winch-capable upgrade replacement to factory bumper
- » Accommodates most winch models up to 12,000lbs.
- » Constructed of 10-gauge steel for strength
- » Heavy-duty 4-gauge winch tray
- » Features 4.5" x 10" winch mount pattern
- » Has provisions for factory sensors
- » Recessed fairlead mount
- » Provides two recovery points for shackles
- » Configured to accept most single or double row 20" LED light bars (sold separately)
- » Optional Westin square auxiliary LED light kit available (sold separately)
- » Hardware and mounting brackets included
- » E-coated base coat provides long lasting corrosion protection
- » Available in textured black powder coat finish

FINISH: Textured Black Powder Coat
MATERIAL: E-Coated Steel
WARRANTY: 3-Year



**HYPERQ B-FORCE LED
AUXILIARY LIGHTS**
PN# 09-12205A-PR (SPOT)
PN# 09-12205B-PR (FLOOD)



**LICENSE
PLATE RE-LOCATOR**
**ROLLER FAIRLEAD
PN# 46-20055**
**HAWSE FAIRLEAD
PN# 46-20065**



HEAVY-DUTY 4-GAUGE WINCH TRAY



**SHOWN: SX 10SR
PN# 1710201
(SOLD SEPARATELY)**

START	END	MAKE	MODEL	TEXTURED BLACK
2016	2018	Chevrolet	Silverado 1500 ^{1,14,15}	58-411005
2019	2021	Chevrolet	Silverado 1500 (Excl. 2019 LD) (Excl. Diesel Models) ^{1,14,15}	58-411215
2022	2022	Chevrolet	Silverado 1500 LTD (Excl. Diesel Models) ^{1,14,15}	58-410215
2019	2019	Chevrolet	Silverado LD ^{1,14,15}	58-411005
2016	2019	Chevrolet	Silverado 2500/3500 ^{1,14,15}	58-411165
2020	2023	Chevrolet	Silverado 2500/3500 ^{1,14,15}	58-411225
2010	2018	Dodge	Ram 2500/3500 ^{1,14,15}	58-411195
2018	2020	Ford	F-150 (Excl. Raptor) ^{1,14,15,17}	58-411065
2021	2023	Ford	F-150 (Excl. 2021+ Lightning EV & Raptor) ^{1,14,15,17}	58-411245
2017	2022	Ford	F-250/350 ^{1,14,15}	58-411175
2022	2023	Nissan	Frontier ^{1,14,15,16,17,18,19}	58-410295
2019	2023	Ram	1500 (Excl. Classic) (Excl. Rebel & Warlock) (Excl. Diesel) ^{1,14,15}	58-411075
2010	2018	Ram	2500/3500 ^{1,14,15}	58-411195
2019	2023	Ram	2500/3500 ^{1,14,15}	58-411235
2014	2021	Toyota	Tundra ^{1,14,15}	58-411025
2022	2023	Toyota	Tundra ^{1,14,15,16,17,18}	58-411235

FOOTNOTES: 6. Compatible With Most Medium Frame 8000-12000lbs Winches. 7. Compatible With One 20 Inch Single Or Double Row LED Light Bar. 8. Compatible With Two HyperQ Square Light Per Side. 9. Roller Fairlead Will Interfere With Parking Sensor. 10. Compatible With TRD Skid Plate. 13. Requires Minor Trimming Of OEM Bumper. 14. Not Compatible With Talon Winch Series. 15. Requires Relocating Adaptive Cruise Control Module. 17. Superwinch Talon Winch Fits At A Slight Offset Position. 19. Excludes Vehicles With Active Park Assist 2.0 If Equipped. 20. Not Compatible With Roller Fairlead. 210. Requires Removal Of OE Crash Bar If Equipped. 211. Removal Of Active Air Dam Will Cause A Dash Warning Message. 212. Compatible With Westin Lights # 09-12232. 236. Compatible With OE PRO-4X Skid Plate 237. Compatible With Two Fusion5 Single Row LED Light Bars Part# 09-12232-PR. 238. Compatible With Two 5-6 Inch Single Row LED Light Bars 239. Compatible With Intelligent Cruise Control Module After It Is Relocated

NEW! PRO-SERIES REAR BUMPER TEXTURED BLACK

- Slim, one-piece modern design*
- Increases ground clearance and angle of approach
- Constructed of 10-gauge steel for strength
- Compatible with parking sensors
- Accommodates OEM hitch
- Configured to accept (2) FM6 LED flush mount lights (sold separately)
- Hardware and mounting brackets included
- E-coated base coat provides long lasting corrosion protection
- Bolt-on installation - no drilling required
- Available in textured black powder coat finish

*2014-2021 Toyota Tundra models are designed with a unique modular 3-piece design instead of the one-piece design standard for all other makes.

FINISH: Textured Black Powder Coat

MATERIAL: E-Coated Steel

WARRANTY: 3-Year



OPTIONAL FM6 FLUSH MOUNT LED LIGHTS
PN# 09-1510FM6 SOLD SEPARATELY

E-COATED BASE COAT
PROVIDES LONG LASTING
CORROSION PROTECTION



START	END	MAKE	MODEL	TEXTURED BLACK
2016	2022	Chevrolet	Colorado (W/O Sensor)	98-421059
2017	2022	Chevrolet	Colorado ZR2	98-421059
2014	2015	Chevrolet	Silverado 1500	98-421005
2019	2023	Chevrolet	Silverado 1500 (Excl. 2019 LD)	98-421215
2020	2023	Chevrolet	Silverado 2500/3500	98-421216
2019	2019	Chevrolet	Silverado LD	98-421005
2009	2018	Dodge	Ram 1500	98-421025
2010	2023	Dodge	Ram 2500-3500	98-421025
2021	2023	Ford	Bronco (Excl. Bronco Sport)	98-421255
2016	2023	Ford	F-150 (Excl. 2022+ Lightning EV & Raptor) *	98-421015
2017	2020	Ford	F-150 Raptor	98-421145
2017	2022	Ford	F-250/350	98-421175
2011	2016	Ford	F-250/350/450/650 Super Duty	98-421205
2019	2022	Ford	Ranger ¹	98-421005
2016	2022	GMC	Canyon (W/O Sensor)	98-421055
2014	2015	GMC	Sierra 1500	98-421005
2019	2022	GMC	Sierra 1500 (Excl. 2019 Limited)	98-421215
2019	2019	GMC	Sierra 1500 Limited	98-421005
2009	2018	Ram	1500	98-421025
2019	2023	Ram	1500 (Excl. Classic)	98-421075
2019	2023	Ram	1500 Classic	98-421025
2010	2023	Ram	2500/3500	98-421025
2016	2023	Toyota	Tacoma ¹⁸	98-421045
2014	2021	Toyota	Tundra ¹⁹	98-421035

FOOTNOTES: 1. Requires Minor Bending/Trimming Of Hitch Sheet Metal. 18. Excludes Vehicles With Blind Spot Monitoring System If Equipped. 19. Excludes Vehicles With Active Park Assist 2.0 If Equipped.

PRO-MOD FRONT BUMPER TEXTURED BLACK

- Modular design
- Smaller package means lower shipping costs
- 10-gauge material provides strength
- Increases ground clearance and angle of approach
- 10-gauge valance included - on some applications
- Bolt on skid plate - sold separately
- Durable textured black powder coat
- Accepts most 30" LED light bar in the center position (sold separately)
- Accepts round or square Outlaw LED auxiliary light kits (sold separately)
- Outrigger brackets provide strength

FINISH: Textured Black Powder Coat
MATERIAL: E-Coated Steel
WARRANTY: 3-Year

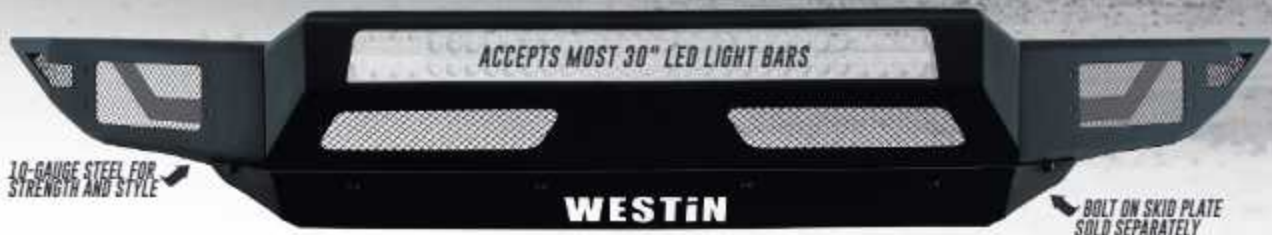

10-GAUGE STEEL FOR STRENGTH AND STYLE

WESTiN

BOLT ON SKID PLATE SOLD SEPARATELY



MODULAR DESIGN REDUCES COSTLY FREIGHT CHARGES: SHIPS PARCEL POST



OPTIONAL LED LIGHT KITS



OPTIONAL LED LIGHT KIT WITH ROUND AUXILIARY LIGHTS. INCLUDES: (2) BRACKETS, (4) LED LIGHTS AND WIRING HARNESS

P/N 50-9905



OPTIONAL SQUARE LED LIGHT KIT WITH HYPERBOLIC AUXILIARY LIGHTS INCLUDES: (2) BRACKETS, (4) LED LIGHTS AND WIRING HARNESS

P/N 50-9925

START	END	MAKE	MODEL	FRONT BUMPER	SKID PLATE
2015	2022	Chevrolet	Colorado (Excl. ZR2) *	50-41095	50-71155
2016	2018	Chevrolet	Silverado 1500	50-41005	50-71005
2019	2021	Chevrolet	Silverado 1500 (Excl. 2019 LD) *	50-41216	50-71216
2022	2022	Chevrolet	Silverado 1500 LTD *	50-41215	50-71215
2016	2019	Chevrolet	Silverado 2500/3500	50-41165	50-71165
2020	2023	Chevrolet	Silverado 2500/3500 *	50-41225	50-71225
2019	2019	Chevrolet	Silverado LD	50-41005	50-71005
2010	2018	Dodge	Ram 2500/3500 *	50-41195	50-71195
2021	2023	Ford	Bronco (Excl. Bronco Sport) **	50-41255	—
2015	2017	Ford	F-150 †	50-41015	50-71015
2017	2020	Ford	F-150 Raptor **	50-41145	—
2018	2020	Ford	F-150 (Excl. Raptor) †	50-41065	50-71015
2021	2023	Ford	F-150 (Excl. 2022+ Lighting EV) †	50-41245	—
2017	2022	Ford	F-250/350 †, †, †	50-41175	50-71175
2021	2018	Ford	F-250/350/450/550 Super Duty †	50-41205	50-71205
2019	2022	Ford	Ranger †	50-41055	50-71055
2013	2018	Ram	1500 (Excl. Rebel & Warlock) †	50-41020	50-71020
2019	2023	Ram	1500 (Excl. Classic) (Excl. Rebel & Warlock)	50-41075	50-71105
2019	2020	Ram	1500 Classic (Excl. Rebel, TRX & Warlock) †	50-41025	50-71025
2010	2018	Ram	2500/3500 †	50-41195	50-71195
2019	2023	Ram	2500/3500 *	50-41235	50-71235
2016	2023	Toyota	Tacoma *	50-41045	50-72005
2014	2021	Toyota	Tundra †, †, †	50-41035	50-72015

FOOTNOTES: 1. Factory Tow Hooks Cannot Be Reused. 2. Requires Removal Of OEM Active Air Dam. 3. Excludes Vehicles With Adaptive Cruise (Speed) Control If Equipped. 4. Requires Relocating Adaptive Cruise (Speed) Control Module. 5. Will Block Approximately 20 Percent Of Camera View. 6. Requires Minor Trimming Of OEM Bumper. 7. Requires Removal Of Skid Plate If Equipped. 8. Compatible With A 40 Inch Light Bar. 9. Not Compatible With OEM Tow Hooks 10. May Require Recalibration Of Blind Spot Monitors By A Toyota Technician If Equipped. 11. May Interfere With Blind Spot Monitoring System If Equipped. 12. Compatible With TRD Skid Plate. 28. Will Interfere With Adaptive Cruise (Speed) Control If Equipped.

WESTIN™ BUMPERS

HDX BANDIT FRONT BUMPER

BLACK POWDER COAT

- » Protects vehicle from damage against wildlife and road debris
- » Heavy duty diamond plate steel
- » Constructed of schedule 40 steel pipe
- » Honeycomb mesh provides protection
- » Heavy duty 2 3/4" wide upright rubber strips
- » 1 1/2" headlight protection tubes
- » 2" tube full wraparound wings ties into bumper
- » Built-in 2" receiver hitch
- » (2) heavy duty 9,500 lbs bow shackle mounts
- » Compatible for factory fog lamps or LED post mount lights
- » Custom die-cast riveted logo badge
- » Mounting provisions for license plate
- » Metal mesh allows maximum air flow to intercooler or radiator area
- » Removable mesh for adaptive cruise control (late Ford only)
- » Removable mesh for factory camera option (late Ford only)
- » Has provisions for factory parking sensors (late Chevrolet & Ram)
- » Bolt-on installation - no drilling required

FINISH: Black Powder Coat
 MATERIAL: E-Coated Steel
 WARRANTY: 3-Year



START	END	MAKE	MODEL	FRONT BUMPER
2019	2021	Chevrolet	Silverado 1500 (Excl. 2019 LD)(Excl. Diesel) 1-4*	58-31126
2022	2022	Chevrolet	Silverado 1500 LTD 1-4*	58-31126
2011	2014	Chevrolet	Silverado 2500/3500†	58-31148
2015	2019	Chevrolet	Silverado 2500/3500†	58-31155
2020	2023	Chevrolet	Silverado 2500/3500†**	58-31185
2010	2016	Dodge	Ram 2500/3500 (Excl. Power Wagon)†	58-31175
2016	2020	Ford	F-150 (Excl. EcoBoost)(Excl. Raptor)†	58-31106
2011	2016	Ford	F-250/350†	58-31119
2017	2020	Ford	F-250/350 1-2,3,4**	58-31124
2023	2023	Ford	F-250/350	58-311205
2010	2016	Ram	2500/3500 (Excl. Power Wagon)†	58-31175
2019	2023	Ram	2500/3500†	58-31199

FOOTNOTES: 1. Factory Tow Hooks Cannot Be Reused. 2. Will Partially Block Camera If Equipped. 4. Not Compatible With OEM Tow Hooks. 5. No Drilling Required. 6. Use Sensor Kit Part # 58-30005 (Sold Separately) To Reuse Sensor If Equipped. 7. Excludes Models With Trim Package Including Parking Sensor. 234. Not Compatible With LED Fog Lamps On 2020-2022 Models.

START	END	MAKE	MODEL	BLACK
2019	2021	Chevrolet	Silverado 1500 (Excl. 2019 LD)†	58-30005
2022	2022	Chevrolet	Silverado 1500 LTD†	58-30005

FOOTNOTES: 1. Drilling of the HDX Bandit Front Bumper is required

HDX BANDIT REAR BUMPER BLACK POWDER COAT

- » Constructed of 11 gauge steel for strength and style
- » Heavy duty diamond plate steel
- » Unique "Corner Step" design provides an extra wide access step area
- » Welded inner structure for maximum strength
- » Protects vehicle from damage against wildlife and road debris
- » Provides added safety to driver and vehicle
- » Compatible for blind spot monitors and parking sensors
- » Accommodate for OEM hitch
- » Custom die-cast riveted logo badge
- » Hardware, mounting brackets and two LED backup lights included
- » Flush mount LED license plate lights included
- » Bolt-on installation - no drilling required

FINISH: Black Powder Coat
MATERIAL: E-Coated Steel
WARRANTY: 3-Year



START	END	MAKE	MODEL	REAR BUMPER
2019	2025	Chevrolet	Silverado 1500 (Excl. 2019 LD) ¹	80-341100
2015	2019	Chevrolet	Silverado 2500/3500	80-341105
2020	2025	Chevrolet	Silverado 2500/3500 ²	80-341105
2009	2018	Dodge	Ram 1500	80-341179
2010	2025	Dodge	Ram 2500/3500 ²	80-341179
2015	2020	Ford	F-150 ¹	80-341105
2011	2016	Ford	F-250/350	80-341110
2017	2022	Ford	F-250/350 ²	80-341125
2019	2022	GMC	Sierra 1500 (Excl. 2019 Limited) ¹	80-341105
2015	2019	GMC	Sierra 2500/3500 ¹	80-341105
2009	2018	Ram	1500	80-341179
2019	2025	Ram	1500 Classic	80-341179
2010	2025	Ram	2500/3500 ²	80-341179

FOOTNOTES: 1. Requires Minor Grinding Of OEM Hitch. 2. Not Compatible With Dual Exhaust Vehicles.

WESTIN | BUMPERS

OUTLAW FRONT BUMPER TEXTURED BLACK

- Mount kit included
- Made of 14 gauge steel
- 2" diameter tube frame
- Integrated bolt-on LED light mounts for up to two single or one double row 30"/20" LED Bar
- Optional Outlaw Skid Plate available - sold separately
- Optional round LED light kit with Westin auxiliary lights available - sold separately
- Optional square LED light kit with Westin auxiliary lights available - sold separately

FINISH: Textured Black
MATERIAL: E-Coated Steel
WARRANTY: 3-Year

ACCOMMODATES 30" DOUBLE ROW LED LIGHT BAR OR 30" / 20" B-FORCE DOUBLE ROW LED LIGHT BAR
PN# 09-12230C (CHROME) OR PN# 09-12212-80C (BLACK) OR PN# 09-12212-80C (30") OR PN# 09-12212-40C (20")



OPTIONAL OUTLAW BUMPER SKID PLATE



OUTLAW BUMPER LICENSE PLATE MOUNT

PN# 58-60055



OPTIONAL LED LIGHT KITS



OPTIONAL LED LIGHT KIT WITH ROUND AUXILIARY LIGHTS. INCLUDED: (2) BRACKETS, (4) LED LIGHTS AND WIRING HARNESS
PN# 58-9905



OPTIONAL SQUARE LED LIGHT KIT WITH HYPERX AUXILIARY LIGHTS INCLUDED: (2) BRACKETS, (4) LED LIGHTS AND WIRING HARNESS
PN# 58-9915

START	END	MAKE	MODEL	FRONT BUMPER	SKID PLATE
2019	2021	Chevrolet	Silverado 1500 (Excl. 2019 LD) **	58-61215	58-71215
2022	2022	Chevrolet	Silverado 1500 LTD **	58-61215	58-71215
2015	2017	Ford	F-150 (Excl. Raptor) *	58-61015	58-71015
2016	2020	Ford	F-150 (Excl. Raptor) *	—	58-71015
2017	2020	Ford	F-150 Raptor *	58-62025	—
2019	2023	Ram	1500 (Excl. Classic) (Excl. Rebel & Warlock) **	58-61075	58-71075
2016	2023	Toyota	Tacoma *	58-61045	58-71045

FOOTNOTES: 1. Requires Trimming Upper Front Bumper Fascia. 3. May Require Minor Trimming Of OEM Fender Flares. 4. Not Compatible With LED Kit Part # 58-9905 & 58-9915. 8. Factory tow hooks cannot be reused. 9. Requires Trimming Bumper Filler. 11. Includes Brackets For Part # 09-12230-PR.

OUTLAW REAR BUMPER TEXTURED BLACK

- Mount kit included
- 2" diameter tube frame
- Optional class III/IV hitch available
- Available for vehicles with or without backup sensors
- Retractable license plate holder conceals receiver hitch - sold separately
- Equipped with mount points for auxiliary lights
- Rear flush mount LED lights sold separately (V5 tested)
- PN# 09-1218FM4 (Pair Pack)
- Bolt-on installation - no drilling required

FINISH: Textured Black Powder Coat
MATERIAL: E-Coated Steel
WARRANTY: 3-Year

REAR FLUSH MOUNT LED LIGHTS SOLD SEPARATELY
PN# 09-1218FM4 (PAIR PACK)



2.0" DIAMETER TUBE

AVAILABLE FOR VEHICLES WITH OR WITHOUT BACKUP SENSORS



REAR FLUSH MOUNT LED LIGHTS
PN# 09-1218FM4



REAR FLUSH MOUNT LED LIGHTS
PN# 09-1218FM6
DODGE RAM MODELS ONLY



OUTLAW BUMPER HITCH

START	END	MAKE	MODEL	REAR BUMPER	HITCH CLASS IV	HITCH CLASS III
2014	2018	Chevrolet	Silverado 1500	58-81005	—	—
2019	2023	Chevrolet	Silverado 1500 (Excl. 2019 LD) **	58-81215	58-81215H	—
2019	2019	Chevrolet	Silverado LTD	58-81005	—	—
2020	2023	Chevrolet	Silverado 2500 HD/3500 HD **	58-81215	58-81215H	—
2017	2020	Ford	F-150 Raptor **	58-82025	—	—
2019	2022	Ford	Ranger *	58-81005	—	58-81035H
2014	2018	GMC	Sierra 1500	58-81005	—	—
2019	2022	GMC	Sierra 1500 (Excl. 2019 Limited)	58-81215	58-81215H	—
2019	2019	GMC	Sierra 1500 Limited	58-81005	—	—
2013	2018	Ram	1500	58-81025	—	—
2019	2023	Ram	1500 Classic	58-81025	—	—
2019	2023	Ram	1500 (Excl. Classic) (Accessory for Outlaw Rear Bumper Only)	58-81075	58-81075H	—
2019	2023	GMC	Sierra 2500/3500	58-81215	58-81215H	—
2016	2023	Toyota	Tacoma *	58-81045	—	—
2014	2021	Toyota	Tundra *	58-81035	—	58-81035H

FOOTNOTES: 1. Excludes Vehicles With Blind Spot Monitoring System If Equipped. 2. Not compatible with OEM hitch. 3. Requires Minor Modification Of OEM Hitch. 4. Compatible With Dual Exhaust Vehicles. 5. Compatible With Blind Spot Monitor If Equipped. 6. Part # 09-1218FM6 Lights Does Not Fit With OEM Hitch. 7. Excludes Vehicles With Active Park Assist 2.0 If Equipped. 8. Compatible With Active Park Assist If Equipped.

BUMPERS**WESTIN®**

PERFECT MATCH BUMPERS

MOLDED POLYMER STEP PADS

- › Factory style
- › Complete assembly
- › Molded polymer step pads
- › V5 tested and certified to SAE J684

FINISH: Chrome, Black and Gray

MATERIAL: Molded Polymer Step Pads

WARRANTY: 3-Year

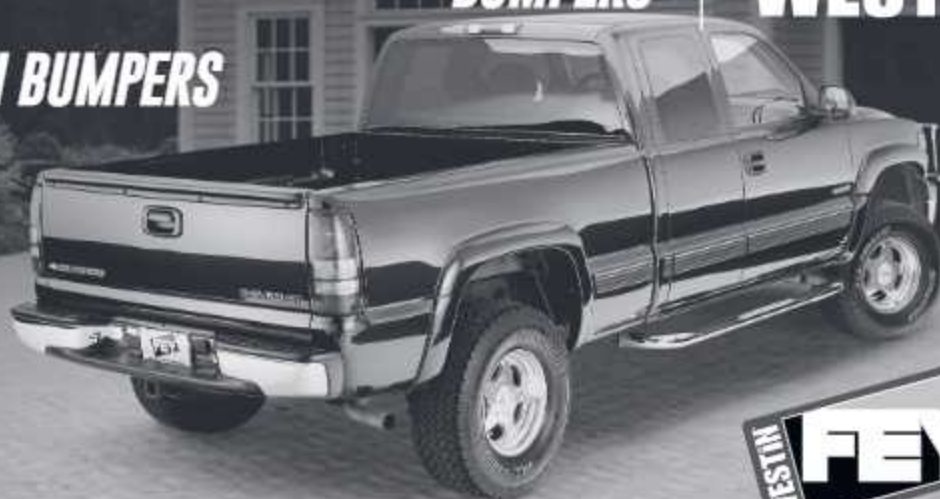

FORD SUPERDUTY
PN# 31002



DODGE RAM
PN# 31005



DODGE RAM
PN# 31004



CHEVROLET/GMC SILVERADO/SIERRA "CLASSIC"
PN# 31006



START	END	MAKE	MODEL	CHROME	BLACK
1992	1994	Chevrolet	Blazer Full size	31001	—
1988	1998	Chevrolet	C/K Series 1500LD	31000	—
1988	2000	Chevrolet	C/K 2500/3500HD (Old Body Style)	31000	—
1992	1999	Chevrolet	Suburban	31001	—
2007	2013	Chevrolet	Silverado 1500 (Excl. Classic) (W/O Sensors)	31023	—
1999	2007	Chevrolet	Silverado 1500LD "Classic" (Fleetside)	31006	—
2001	2007	Chevrolet	Silverado 2500/3500HD "Classic"	31013	—
1999	2004	Chevrolet	Silverado 2500LD (Fleetside)	31006	—
1995	1999	Chevrolet	Tahoe	31001	—
1994.5	2001	Dodge	Ram 1500	31005	—
2004	2008	Dodge	Ram 1500/2500/3500	31017	—
1994	2002	Dodge	Ram 2500/3500	31006	—
1999	2007	Ford	F-250/350/450/550HD Super Duty ¹	31003	—
1988	1998	GMC	C/K Series 1500LD	31000	—
1988	2000	GMC	C/K 2500/3500HD (Old Body Style)	31000	—
2007	2013	GMC	Sierra 1500 4 (W/O Sensors)	31023	—
1999	2007	GMC	Sierra 1500LD "Classic" (Fleetside)	31006	—
2001	2007	GMC	Sierra 2500/3500HD "Classic"	31013	—
1999	2004	GMC	Sierra 2500LD (Fleetside)	31006	—
1992	1999	GMC	Suburban	31001	—
1995	1999	GMC	Yukon	31001	—
1995	2004	Toyota	Tacoma	31018	32018

FOOTNOTES: 1. Will Interfere With Parking Sensor If Equipped.

WESTIN™ BUMPERS

UNIVERSAL SERIES BUMPERS

CHROME, BLACK AND SILVER

FINISH: Chrome, Black and Silver

MATERIAL: Cold Rolled Steel

WARRANTY: 3-Year



DIAMONDSTEP™

- » Popular diamond tread design
- » Full size tongue wt. of 800 lbs & 8,000 lbs trailer wt.
- » Downsize and compact are 350 lbs tongue weight and 3,500 lbs trailer weight certified
- » V5 tested certified to SAE J684
- » Chrome, black and silver powder coat finish



SURESTEP™

- » Full size tongue wt. of 800 lbs & 8,000 lbs trailer wt.
- » 7 gauge hitch plate for full size
- » 10 gauge hitch for mid size and compact
- » 12 gauge face channel for full size
- » 13 gauge for mid size and compact
- » Cold rolled bright steel face channel
- » Factory style steel step plate
- » V5 tested certified to SAE J684
- » Molded polymer step surface



SURESTEP™ DELUXE

- » Full size tongue wt. of 800 lbs & 8,000 lbs trailer wt.
- » 12 gauge face channel for full size
- » 13 gauge for mid size and compact
- » Cold rolled bright steel face channel
- » Factory style steel step plate
- » V5 tested certified to SAE J684
- » Molded polymer step surface
- » Molded flange

START	END	MAKE	MODEL	DIAMONDSTEP™			SURESTEP™			SURESTEP™ DELUXE		REQUIRED MOUNT KIT
				BLACK	SILVER	CHROME	BLACK	SILVER	CHROME	SILVER	CHROME	
1973	1991	Chevrolet	C/K Fleetside Crew Cab	20000	20002	21000	—	20022	21002	—	21007	92230
1988	2000	Chevrolet	C/K Series	20009	20008	—	—	—	—	—	—	92230
1987	1972	Chevrolet	Fleetside (Long Bed)	20000	20002	21000	—	20022	21002	—	21007	92500
1973	1987	Chevrolet	Fleetside Reg (Ext Cab)	20000	20002	21000	—	20022	21002	—	21007	92230
1983	2004	Chevrolet	S-Series (Sport Package Only)*	66000	—	76000	66001	—	76001	—	—	97200
1983	1996	Dodge	D50 Pickup	61000	—	71000	61001	—	71001	—	—	94400
1987	1993	Dodge	D50 Pickup	61000	—	71000	61001	—	71001	—	—	95500
1987	1996	Dodge	Dakota	63000	—	73000	—	—	—	—	—	97800
1997	2004	Dodge	Dakota (Excl. Quad Cab)	63000	—	73000	—	—	—	—	—	91800
1972	1993	Dodge	Fleetside	20000	20002	21000	—	20022	21002	—	21007	92230
1994.5	2001	Dodge	Ram 1500	20009	20008	—	—	—	—	—	—	92240
1994	2002	Dodge	Ram 2500/3500	20009	20008	—	—	—	—	—	—	92240
1978	1985	Dodge	Ram Charger	20000	20002	21000	—	20022	21002	—	21007	92400
1978	1996	Ford	Bronco	20000	20002	21000	—	20022	21002	—	21007	95600
1987	1996	Ford	F-250/3500HD (Excl. F-250LD/Inst. Square Body)	20000	20002	21000	—	20022	21002	—	21007	92230
1987	1996	Ford	F-Series Styleside (All)	20000	20002	21000	—	20022	21002	—	21007	92230
1982	2004	Ford	Ranger (Excl. Splash)*	66000	—	76000	66001	—	76001	—	—	97200
1973	1991	GMC	C/K Fleetside Crew Cab	20000	20002	21000	—	20022	21002	—	21007	92230
1988	2000	GMC	C/K Series	20009	20008	—	—	—	—	—	—	92230
1987	1972	GMC	Fleetside (Long Bed)	20000	20002	21000	—	20022	21002	—	21007	92500
1973	1987	GMC	Fleetside Reg (Ext Cab)	20000	20002	21000	—	20022	21002	—	21007	92230
1983	2004	GMC	S-Series (Sport Package Only)*	66000	—	76000	61001	—	76001	—	—	97200
1996	2004	Isuzu	Hombre	66000	—	76000	61001	—	76001	—	—	97200
1987	1992	Jeep	Comanche	63000	—	73000	66001	—	71001	—	—	97900
1986	1993	Mazda	Pickup	65000	—	—	—	—	—	—	—	95800
1994	2004	Mazda	Pickup	66000	—	76000	66001	—	76001	—	—	97200
1983	1996	Mitsubishi	Pickup	61000	—	71000	61001	—	76001	—	—	94400
1987	1997	Mitsubishi	Pickup	61000	—	71000	61001	—	71001	—	—	95500
1996.5	2004	Nissan	Pickup (Excl. Frontier)	66000	—	76000	66001	—	76001	—	—	93200
1980	1988	Toyota	Pickup	61000	—	71000	61001	—	71001	—	—	94400
1989	1994	Toyota	Pickup	61000	—	71000	61001	—	71001	—	—	93500
1996	1999	Toyota	Tacoma	66000	—	76000	66001	—	76001	—	—	93700

FOOTNOTES: 1. Excludes Vehicles With Tailgate Lights. 2. Fits Models With Best Preferred Equipment Group. 3. Not Compatible With OEM Hitch.



NEW! - Mesa Roof Rack 84



NEW! - XTS Front Bumper 84



NEW! - XTS Brush Guard 85



NEW! - XTS Overhead Light Mount 86

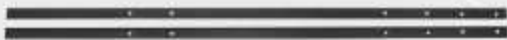

NEW! - XTS Pinch Weld Covers 86



Pro-Mod Front Bumper 87



Pro-Series Rear Bumper 87



Nerf Step Bars and Running Boards 88

WESTIN | FORD BRONCO

NEW! MESA ROOF RACK TEXTURED BLACK

- » All aluminum construction
- » Multi-purpose "cargo management system" allows variety of gear storage
- » Engineered for most roof top tents
- » Top support rails mounted in multiple positions
- » Ability to remove the hardtop panels while rack is installed
- » Removable wind deflector panel to reveal light mount channel
- » Bolt-on installation - no drilling required
- » Hardware and mounting brackets included
- » Electrostatic base coat provides long lasting corrosion protection
- » Available in textured black finish

FINISH: Textured Black Powder Coat
MATERIAL: E-Coated Steel
WARRANTY: 3-Year



OPTIONAL ACCESSORIES:



AXIS ROUND LED
AUXILIARY LIGHTS
P/N 09-12007A-PR (SPOT)
P/N 09-12007B-PR (FLOOD)



AXIS SQUARE LED
AUXILIARY LIGHTS
P/N 09-12219A-PR (SPOT)
P/N 09-12219B-PR (FLOOD)

START	END	MAKE	MODEL
2021	2023	Ford	Bronco 4Dr (Excl. Sport)

TEXTURED BLACK
15-00015

NEW! XTS FRONT BUMPER TEXTURED BLACK

- » High strength, lightweight design
- » Low profile winch mount improves air flow
- » Integrated lightweight 10-gauge steel shell & 4-gauge steel winch tray provides superior strength at an affordable price
- » Features 4.5" x 10" winch mount pattern
- » Accommodates most winches up to 12,000 lbs. capacity
- » Provides two recovery points for shackles
- » Compatible with all factory sensors
- » Optional skid plate (sold separately)
- » Optional round bull bar or angular bull bars (sold separately)
- » Hardware and mounting brackets included
- » E-coated base coat provides long lasting corrosion protection
- » Available in textured black finish

FINISH: Textured Black Powder Coat
MATERIAL: E-Coated Steel
WARRANTY: 3-Year



OPTIONAL PRODUCTS FOR XTS FRONT BUMPER



SX 10SR
PN# 1710201



XTS/PRO-MOD SKID PLATE
PN# 59-721255



XTS ROUND BULL BAR
PN# 59-731255



XTS ANGULAR BULL BAR
PN# 59-741255



FUSION5 SINGLE ROW LIGHT BAR
PN# 09-12232

START	END	MAKE	MODEL
2021	2023	Ford	Bronco (W/ Sensor)(Excl. Bronco Sport, Heritage, Heritage Limited)*†‡§¶

TEXTURED BLACK SKID PLATE
59-711255 59-721255

START	END	MAKE	MODEL
2021	2023	Ford	Bronco (Excl. Bronco Sport)*†‡§¶

ANGULAR BULL BAR ROUND BULL BAR
59-741255 59-731255

FOOTNOTES: 28. Will Interfere With Adaptive Cruise (Speed) Control If Equipped. 91. Compatible With Most Medium Frame 8000-12000lbs Winches. 195. Will Partially Block Camera View. 220. Compatible With One 20 Inch Single Row LED Light Bar. 231. Not Compatible with OEM Bumper. 232. Fits XTS Bumpers Only.

NEW! XTS BRUSH GUARD FOR WESTIN XTS FRONT BUMPER
TEXTURED BLACK

- » 2" diameter tubing for maximum durability
- » Constructed of 10-gauge steel uprights for strength and style
- » Wraparound brush guards protects headlights and grille from damage
- » Designed to mount onto Westin XTS Front Bumper (sold separately)
- » Optional light mounting center bars
- » Clears most winches up to 12,000 lbs. capacity
- » Compatible with all factory sensors
- » Optional round LED light kit with Westin auxiliary lights available (sold separately)
- » Optional square LED light kit with Westin auxiliary lights available (sold separately)
- » Bolt-on installation - no drilling required
- » Hardware and mounting brackets included
- » Electrostatic base coat provides long lasting corrosion protection
- » Available in textured black finish

FINISH: Textured Black Powder Coat
MATERIAL: E-Coated Steel
WARRANTY: 3-Year



OPTIONAL PRODUCTS FOR XTS BRUSH GUARD



SX 10SR
P/N 1710201



SX 12SR
P/N 1712201



XTS FRONT BUMPER
P/N 59-711255



FUSIONS SINGLE ROW LIGHT BAR
P/N 09-12232-PR



OPTIONAL HYPERQ B-FORCE P/N 09-12205A-PR OR
HYPERQ LED LIGHTS P/N 09-12200A-PR

START END MAKE MODEL

2021 2025 Ford Bronco (Excl. Bronco Sport, Heritage, Heritage Limited)

TEXTURED BLACK

59-761255

NEW! XTS BRUSH GUARD FOR OE STEEL FRONT BUMPER
TEXTURED BLACK

- » 2" diameter tubing for maximum durability
- » Constructed of 10-gauge steel uprights for strength and style
- » Wraparound brush guards protects headlights and grille from damage
- » Designed for OE steel bumper
- » Bolt-on design using factory holes
- » Clears most winches up to 12,000 lbs. capacity
- » Compatible with all factory sensors
- » Optional light mounting center bars
- » Optional round LED light kit with Westin auxiliary lights available (sold separately)
- » Optional square LED light kit with Westin auxiliary lights available (sold separately)
- » Bolt-on installation - no drilling required
- » Hardware and mounting brackets included
- » Electrostatic base coat provides long lasting corrosion protection
- » Available in textured black finish

FINISH: Textured Black Powder Coat
MATERIAL: E-Coated Steel
WARRANTY: 3-Year



OPTIONAL ACCESSORIES:

OPTIONAL LIGHT MOUNTING
CENTER BARS



AXIS LED
AUXILIARY LIGHTS
P/N 09-12007A-PR (SPOT)



AXIS LED
AUXILIARY LIGHTS
P/N 09-12007B-PR (FLOOD)

START END MAKE MODEL

2021 2025 Ford Bronco (Excl. Bronco Sport, Heritage, Heritage Limited)

TEXTURED BLACK

59-751255

WESTIN™

FORD BRONCO

NEW! XTS OVERHEAD LIGHT MOUNT

TEXTURED BLACK

- » Manufactured from heavy gauge mild steel and 1.5" tubing
- » Available for Ford Bronco models
- » Specifically engineered for OE Ford Bronco "Accessory Ready" factory roof mounting locations
- » Optional Westin round or square LED auxiliary light kits available (sold separately)
- » Will accommodate most LED lights
- » Bolt-on installation – no drilling required
- » Hardware and mounting brackets included
- » Electrostatic base coat provides long lasting corrosion protection
- » Available in textured black finish



FINISH: Textured Black Powder Coat
 MATERIAL: E-Coated Steel
 WARRANTY: 3-Year

OPTIONAL ACCESSORIES:



AXIS ROUND LED
 AUXILIARY LIGHTS
 P/N 09-12007A-PR (SPOT)
 P/N 09-12007B-PR (FLOOD)



AXIS SQUARE LED
 AUXILIARY LIGHTS
 P/N 09-12219A-PR (SPOT)
 P/N 09-12219B-PR (FLOOD)

START	END	MAKE	MODEL
2021	2023	Ford	Bronco (Excl. Bronco Sport) ²¹³

TEXTURED BLACK
 37-711253

FOOTNOTES: 213. Compatible With Factory Roof Mounting Locations.

NEW! XTS PINCH WELD COVERS

TEXTURED BLACK

- » Available for 2 and 4 door Broncos
- » Covers up unsightly pinch weld
- » Precision laser cut from 16-gauge steel
- » Bolt-on installation – no drilling required
- » Hardware and mounting brackets included
- » Sold in pairs
- » Electrostatic base coat provides long lasting corrosion protection
- » Available in textured black finish



XTS PINCH WELD COVERS
 P/N 42-141855 (2 DOOR)

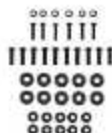

XTS PINCH WELD COVERS
 P/N 42-141955 (4 DOOR)

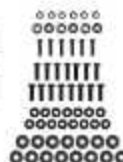

FINISH: Textured Black Powder Coat
 MATERIAL: E-Coated Steel
 WARRANTY: 3-Year



START	END	MAKE	MODEL
2021	2023	Ford	Bronco 2Dr (Excl. Bronco Sport) ²¹³
2021	2023	Ford	Bronco 4Dr (Excl. Bronco Sport) ²¹⁴

TEXTURED BLACK
 42-141855
 42-141955

FOOTNOTES: 213. Compatible With Factory Roof Mounting Locations.

FORD BRONCO

WESTIN®

PRO-MOD FRONT BUMPER

TEXTURED BLACK

- » Tucked design provides improved approach angle
- » Lightweight modular design reduces shipping costs
- » Mesh screen allows maximum air flow to intercooler or radiator area
- » Bolt on skid plate available - sold separately
- » Outrigger brackets support the wings of the bumper for maximum strength
- » Hardware and mounting brackets included
- » E-coated base coat provides long lasting corrosion protection

FINISH: Textured Black Powder Coat
MATERIAL: E-Coated Steel
WARRANTY: 3-Year



ACCEPTS MOST 20" LED LIGHT BARS

WESTIN

UP TO

85% FREIGHT SAVINGS

WITH MODULAR PRODUCTS

UP TO &

50% INVENTORY SPACE REDUCTION

WITH MODULAR PRODUCTS



B-FORCE DOUBLE ROW LIGHT BAR
P/N 09-12212-40C

MODULAR DESIGN REDUCES COSTLY FREIGHT CHARGES: SHIPS PARCEL POST



OPTIONAL LED LIGHT KITS



OPTIONAL LED LIGHT KIT WITH ROUND AUXILIARY LIGHTS. INCLUDES: (2) BRACKETS, (4) LED LIGHTS AND WIRING HARNESS
P/N 58-9905

OPTIONAL SQUARE LED LIGHT KIT WITH RYPER® AUXILIARY LIGHTS. INCLUDES: (2) BRACKETS, (4) LED LIGHTS AND WIRING HARNESS
P/N 58-9915

START	END	MAKE	MODEL
2021	2023	Ford	Bronco (Excl. Bronco Sport)™

TEXTURED BLACK	SKID PLATE
98-41255	-

FOOTNOTES: 28. Will Interfere With Adaptive Cruise (Speed) Control if Equipped.

PRO-SERIES REAR BUMPER

TEXTURED BLACK

- » Slim, one-piece modern design
- » Increases ground clearance and angle of approach
- » Constructed of 10-gauge steel for strength
- » Compatible with parking sensors
- » Accommodates OEM hitch
- » Configured to accept (2) FM6 LED flush mount lights (sold separately)
- » Hardware and mounting brackets included
- » E-coated base coat provides long lasting corrosion protection
- » Bolt-on installation - no drilling required
- » Available in textured black powder coat finish

FINISH: Textured Black Powder Coat
MATERIAL: E-Coated Steel
WARRANTY: 3-Year



OPTIONAL PRODUCTS



FM6 FLUSH MOUNT LED LIGHTS
P/N 09-1918FM6



LICENSE PLATE RELOCATOR BRACKET
P/N 58-42055

START	END	MAKE	MODEL
2021	2023	Ford	Bronco (Excl. Bronco Sport)

TEXTURED BLACK
58-421255

HDX DROP NERF STEP BARS

- » Die stamped steel step areas for maximum traction
- » Provides over 2 more inches of toe/heel step area than our competitors
- » Removable step plates for easy cleaning
- » Fits tight to rocker panel for a solid fit and rugged look
- » Solid 1-piece construction
- » Bolt-on installation – no drilling required
- » Mount kit included

FINISH: Textured Black Powder Coat

MATERIAL: E-Coated Steel

WARRANTY: 3-Year

START	END	MAKE	MODEL	TEXTURED BLACK
2021	2023	Ford	Bronco 2Dr (Excl. Bronco Sport)	66-14188
2021	2023	Ford	Bronco 4Dr (Excl. Bronco Sport)	66-14199



HDX STAINLESS DROP NERF STEP BARS

- » Built with corrosion resistant, black powder-coated stainless steel
- » Die stamped stainless steel step areas for maximum traction
- » Includes stainless steel step plates
- » Rust resistant step plates
- » Fits tight to rocker panel for a solid fit and rugged look
- » Solid 1-piece construction
- » Bolt-on installation – no drilling required
- » Mount kit included

FINISH: Textured Black Powder Coat

MATERIAL: 410 Stainless Steel

WARRANTY: 5-Year

START	END	MAKE	MODEL	TEXTURED BLACK
2021	2023	Ford	Bronco 2Dr (Excl. Bronco Sport)	—
2021	2023	Ford	Bronco 4Dr (Excl. Bronco Sport)	66-141992



XTS ROCK SLIDERS

- » Custom profile to match vehicle's contour
- » Reinforced for maximum strength
- » 12-gauge steel channel
- » 1-3/4" diameter, 120" thick wall round tube

FINISH: Textured Black Powder Coat

MATERIAL: E-Coated Steel

WARRANTY: 3-Year

START	END	MAKE	MODEL	TEXTURED BLACK
2021	2023	Ford	Bronco 2Dr (Excl. Bronco Sport)	42-14189
2021	2023	Ford	Bronco 4Dr (Excl. Bronco Sport)	42-14199



NEW! OUTLAW DROP NERF STEP BARS

- » Stylized step with premium features at an affordable price
- » Constructed of 1.5" diameter mandrel bent steel tube
- » Distinctive 4" drop die-stamped step plate provides maximum traction while cleaning dirt, mud, and debris

FINISH: Textured Black Powder Coat

MATERIAL: E-Coated Steel

WARRANTY: 3-Year

START	END	MAKE	MODEL	TEXTURED BLACK
2021	2023	Ford	Bronco 2Dr (Excl. Bronco Sport)	20-14189
2021	2023	Ford	Bronco 4Dr (Excl. Bronco Sport)	20-14199



PRO TRAXX 5 OVAL NERF STEP BARS

- » 5" oval tube
- » 30° factory style bends at each end
- » Fully welded domed ends
- » Injection molded polymer step pad
- » 5" wide step area
- » Bolt-on installation – no drilling required

FINISH: Polished
MATERIAL: 304 Stainless Steel
WARRANTY: Lifetime

FINISH: Textured Black Powder Coat
MATERIAL: E-Coated Steel
WARRANTY: 3-Year

START	END	MAKE	MODEL	SIZE	MTNG	POLISHED	BLACK
2021	2023	Ford	Bronco 4Dr (Excl. Bronco Sport) **	5"	Rocker Pnl.	-	21-24168

FOOTNOTES: 198. Requires Removal Of Rock Sliders If Equipped.



GRATE STEPS RUNNING BOARDS

- » Engineered to provide maximum traction without sacrificing style
- » Serrated edges help clean dirt, snow, and mud off your boots to keep truck cab clean
- » Aggressive 1/4" high punched tread allows for traction in any weather condition

FINISH: Textured Black Powder Coat
MATERIAL: E-Coated Steel
WARRANTY: 3-Year

START	END	MAKE	MODEL	TEXTURED BLACK	REQUIRED MOUNT KIT
2021	2023	Ford	Bronco 2Dr (Excl. Bronco Sport)	27-74795	27-2425
2021	2023	Ford	Bronco 4Dr (Excl. Bronco Sport)	27-74729	27-2425



MOLDED RUNNING BOARDS

- » Protects vehicle rocker panels from potential damage
- » Factory style design
- » UV resistant black molded polymer
- » Available in lighted and unlighted

FINISH: Black

MATERIAL: Molded Polymer Step & Aluminum Board

WARRANTY: 3 Year

START	END	MAKE	MODEL	UNLIGHTED	LIGHTED	REQUIRED MOUNT KIT
2021	2023	Ford	Bronco 4Dr (Excl. Bronco Sport)	27-0000	27-0005	27-2425



SURE-GRIP RUNNING BOARDS

- » Protects vehicle rocker panels from potential damage
- » Slip resistant textured step surface
- » Injection molded polymer end caps
- » Rocker panel gap strip for finished look
- » Optional light kit available (part no. 27-6000)

FINISH: Polished, Brushed & Black
MATERIAL: Extruded Rubber Step & Aluminum Board

WARRANTY: 3-Year

START	END	MAKE	MODEL	LENGTH	POLISHED	BRUSHED	BLACK	REQUIRED MOUNT KIT
2021	2023	Ford	Bronco 2Dr (Excl. Bronco Sport)	64"	27-6600	27-6100	27-6105	27-2425
2021	2023	Ford	Bronco 4Dr (Excl. Bronco Sport)	74"	27-6620	27-6120	27-6125	27-2425



SG6 RUNNING BOARDS

- » Stylish modern design
- » 5 1/2" step surface width
- » Corrosion resistant extruded aluminum board
- » Slip resistant textured step surface
- » Rocker panel gap strip included for finished look

FINISH: Polished

MATERIAL: Aluminum

WARRANTY: 5 Year

FINISH: Black

MATERIAL: Aluminum

WARRANTY: 5-Year

START	END	MAKE	MODEL	LENGTH	POLISHED	BLACK	REQUIRED MOUNT KIT
2021	2023	Ford	Bronco 4Dr (Excl. Bronco Sport)	75"	27-64720	27-64725	27-2425



SG6 LED RUNNING BOARDS

- » Stylish modern design
- » 5 1/2" step surface width

FINISH: Polished

MATERIAL: Aluminum

WARRANTY: 5-Year

LED WARRANTY: Limited Lifetime

FINISH: Black

MATERIAL: Aluminum

WARRANTY: 5-Year

LED WARRANTY: Limited Lifetime

START	END	MAKE	MODEL	LENGTH	POLISHED	BLACK	REQUIRED MOUNT KIT
2021	2023	Ford	Bronco 4Dr (Excl. Bronco Sport)	75"	27-64720	27-64725	27-2425



	NEW! - Pro-e Running Boards	90
	NEW! - XTS Rock Sliders	90
	WJ2 Stubby Bumpers	91
	WJ2 Full Width Front Bumpers	92
	WJ2 Rear Bumpers.....	93
	Inner Fenders / Tube Fenders	95-96
	Triple Tube Rock Rail Steps & Rock Slider Steps.....	97
	LED Light Mounts	98
	Skid Plates	99
	Nerf Step Bars and Running Boards	100
	MAX Winch Mounting System	101
	LED Hood Scoops, Body Trim, Products	102

WESTIN

JEEP® WRANGLER/GLADIATOR

NEW!

PRO-2 RUNNING BOARDS

TEXTURED BLACK

- » Running board automatically deploys when any door is open then retracts when door is close
- » 2 waterproof IP68 rated motors per side
- » Included LED lights illuminate step surface
- » Protects vehicle rocker panels from potential damage
- » 6" wide durable aluminum running boards
- » 600 lbs. weight capacity (300 lbs. per side)
- » Corrosion resistant aluminum boards
- » Bolt-on installation - no drilling required
- » Hardware and mounting brackets included
- » Available in black powder coat finish



FINISH: Textured Black Powder Coat

MATERIAL: Aluminum

WARRANTY: 5-Year

LED LIGHT WARRANTY: Limited Lifetime

START	END	MAKE	MODEL	LENGTH (IN)	TEXTURED BLACK
2020	2023	Jeep	Gladiator		29-24163
2016	2023	Jeep	Wrangler JL Unlimited 4Dr		29-24063

NEW! XTS ROCK SLIDERS

TEXTURED BLACK

- » Custom profile to match vehicle's contour
- » Reinforced for maximum strength
- » 12-gauge steel channel
- » 1-3/4" diameter, .120" thick wall round tube
- » Bolt-on step plate with polyurea texture coated grip surface
- » Hardware and mounting brackets included
- » Electrostatic base coat provides long lasting corrosion protection
- » Bolt-on installation - no drilling required
- » Available in textured black powder coat finish



FINISH: Textured Black Powder Coat

MATERIAL: E-Coated Steel

WARRANTY: 3-Year

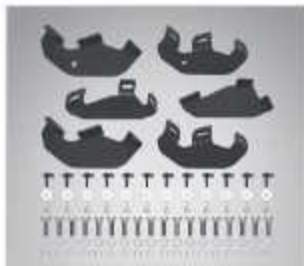

START	END	MAKE	MODEL	TEXTURED BLACK
2020	2023	Jeep	Gladiator	42-14163
2016	2023	Jeep	Wrangler JL Unlimited 4Dr	42-14063

WJ2 STUBBY BUMPERS TEXTURED BLACK

- » 3/16" plate steel construction
- » Designed to allow winch installation with bumper installed
- » Winches fit inside bumper to allow maximum air flow to the radiator
- » 2 side and 2 front off-road jack points
- » Rock Light mount points on lower bumper corners
- » 2 corner post mount points
- » Recovery hooks feature shackle mount point and hook for easy strap attachment
- » Optional skid plate available - sold separately
- » Bolt-on installation - no drilling required
- » Includes bumper, mounting hardware and install instruction

FINISH: Textured Black Powder Coat
MATERIAL: E-Coated Steel
WARRANTY: 3-Year



DIRECT FIT FOR
LED ROCK LIGHT KIT
PN# 09-80005



WJ2 STUBBY BUMPER W/ LED LIGHT BAR MOUNT*



ADD A SKID PLATE



WJ2 FRONT BUMPER SKID PLATE
PN# 59-80095 (JL OR GLADIATOR) OR PN# 59-80005-SP (JK)
BOTH INCLUDE WINCH COVER PLATE

WJ2 STUBBY BUMPER W/ BULL BAR*



WJ2 STUBBY BUMPER*



START	END	MAKE	MODEL
2007	2018	Jeep	Wrangler JK™
2010	2020	Jeep	Wrangler JL™
2020	2023	Jeep	Gladiator™

WJ2 FRONT STUBBY BUMPER		
FRONT	WITH LED LIGHT BAR MOUNT	WITH BULL BAR
—	59-80023	59-80015
59-80065	59-80085	59-80075
59-80065	59-80085	59-80075

FOOTNOTES: 1. Minor Frame Modifications May Be Required For Some Competitor Winches. 2. *Requires Relocation Of Vacuum Pump For Some Competitor Winches.

WJ2 FULL WIDTH FRONT BUMPERS

TEXTURED BLACK

- 3/16" plate steel construction
- LED light bar mount fits most 20" single row light bar
- Designed to allow winch installation with bumper installed
- Winches fit inside bumper to allow maximum air flow to the radiator
- 2 front off-road jack points
- Factory fog lights compatible
- Rock Light mount points on lower bumper corners
- Recovery hooks feature shackle mount point and hook for easy strap attachment
- Optional skid plate available - sold separately
- Bolt-on installation - no drilling required
- Includes bumper, mounting hardware and install instructions

FINISH: Textured Black Powder Coat

MATERIAL: E-Coated Steel

WARRANTY: 3-Year



ADD A SKID PLATE



WJ2 FRONT BUMPER SKID PLATE

PN# 59-80095 (JL OR GLADIATOR) OR PN# 59-80005-SP (JK)

BOTH INCLUDE WINCH COVER PLATE



DIRECT FIT FOR
**LED ROCK
LIGHT KIT**
PN# 09-80005

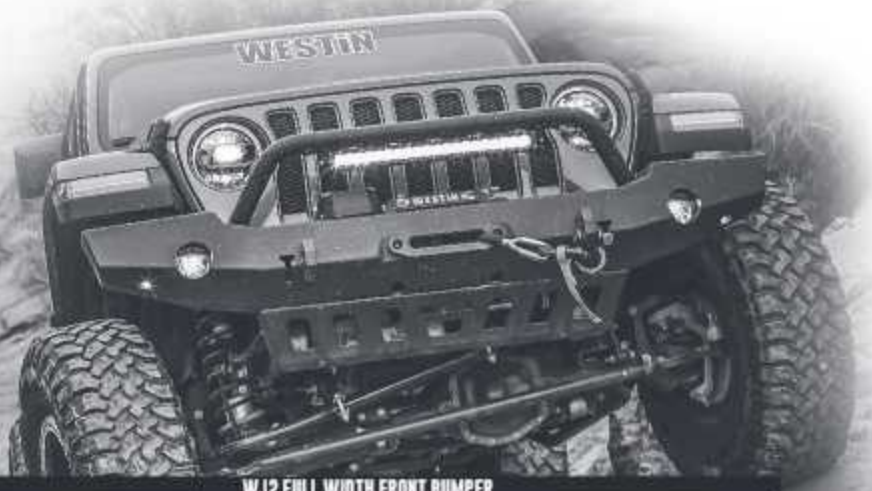

WJ2 FULL WIDTH FRONT BUMPER

START	END	MAKE	MODEL	FRONT	WITH LED LIGHT BAR MOUNT	WITH BULL BAR
2020	2023	Jeep	Gladiator	59-80105	59-80125	59-80115
2007	2016	Jeep	Wrangler JK/JK*	59-80035	59-80055	59-80045
2016	2023	Jeep	Wrangler JL*	59-80105	59-80125	59-80115

FOOTNOTES: 1. *Requires Graining Of Vehicle Frame Bracket For Some Competitor Winches 2. Requires Relocation Of Vacuum Pump For Some Competitor Winches.

WJ2 REAR BUMPER

TEXTURED BLACK

- » 3/16" plate steel construction
- » 8-gauge tire carrier (Up to 37" tire)
- » Carrier opens and closes with tailgate
- » Bumper designed to work with or without factory or Westin hitches
- » Tapered roller bearings and 2 turnbuckle heim links improve carrier rigidity
- » Bolt-on spindle allows adjustment of carrier separate from bumper
- » Bottom frame mount prevents bumper from rotating
- » Integrated recovery shackle mount points
- » Auxiliary Light mount points for post mount square lights
- » Rock light mount points on lower bumper corners
- » 2 off-road jack points
- » Bolt-on installation - no drilling required
- » Includes bumper, mounting hardware and install instructions

FINISH: Textured Black Powder Coat

MATERIAL: E-Coated Steel

WARRANTY: 3-Year



JL WJ2 REAR BUMPER INCLUDES:

- FACTORY BACKUP CAMERA RELOCATION KIT
- SIDE QUARTER PANEL COVER PLATES
- TOWING PLUG RELOCATOR BRACKET



DIRECT FIT FOR
LED ROCK LIGHT KIT
PN# 09-80005



MORE WJ2 ACCESSORIES

- WJ2 LED LIGHT BAR BRACKET KIT FOR WJ2 BULL BARS
- WJ2 OFF-ROAD JACK MOUNT
- WJ2 3RD BRAKE LIGHT/ROTOPAX® COMBO MOUNT
- WJ2 SPARE TIRE RELOCATOR

*JL shown, JK available

START	END	MAKE	MODEL	WJ2 REAR BUMPER	W/O TIRE CARRIER W/ SENSOR	W/TIRE CARRIER W/O SENSOR	W/TIRE CARRIER W/SENSOR
2020	2020	Jeep	Gladiator	\$9-82065	\$9-82075	—	—
2007	2018	Jeep	Wrangler JK	\$9-82009	—	\$9-82019	—
2018	2020	Jeep	Wrangler JL (W Sensors)	—	\$9-82045	—	\$9-82055
2018	2020	Jeep	Wrangler JL (W/O Sensors)	\$9-82025	—	\$9-82035	—

FOOTNOTES: 1. Minor drilling on 2007-2012 vehicles

LED LIGHT BAR BRACKET KIT FOR WJ2 WITH BULL BAR

- » Add a 20" LED light bar to your WJ2 Stubby and Full Width with Bull Bar
- » High quality, sturdy steel plate construction
- » Designed so light bar mounts behind bull bar plane for protection

- » Buttonhead bolts to match Westin bull bar
- » Brackets include 2 holes for fit and durability
- » Includes slots to accommodate different styles of light bars

FINISH: Textured Black Powder Coat
 MATERIAL: E-Coated Steel
 WARRANTY: 3-Year

LED BRACKET KIT

START	END	MAKE	MODEL
2007	2018	Jeep	Wrangler JK
2018	2023	Jeep	Wrangler JL

PART NO.

59-88015

59-88015

WJ2 ACCESSORIES

OFF-ROAD JACK MOUNT

- » Black steel mounting base plate and hardware
- » Includes bracket and adjustable security latches

FINISH: Textured Black
 MATERIAL: E-Coated Steel
 WARRANTY: 3 Year



3RD BRAKE LIGHT ROTOPAX® COMBO MOUNT



- » Allows for secure mounting of any 2 gallon RotoPax® container
- » Fits 2007-2018 Jeep Wrangler JK
- » Easy installation
- » Mounting hardware included
- » No drilling required

FINISH: Textured Black Powder Coat
 MATERIAL: E-Coated Steel
 WARRANTY: 3-Year

WJ2 SPARE TIRE RELOCATOR



- » Accommodates a tire up to 37" in diameter
- » Retains use of factory third brake light and rear view camera
- » Retains functionality of factory spare tire rubber isolators
- » No modification of factory wiring required

FINISH: Textured Black Powder Coat
 MATERIAL: E-Coated Steel
 WARRANTY: 3-Year

START	END	MAKE	MODEL	PRODUCT NAME	TEXTURED BLACK
2018	2023	Jeep	Wrangler JL	Off-Road Jack Mount	59-89015
2007	2018	Jeep	Wrangler JK	RotoPax Mount	59-88025
2018	2023	Jeep	Wrangler JL	RotoPax Mount	59-88025
2007	2018	Jeep	Wrangler JK	3rd Brake Light/RotoPax Combo Mount	59-89035
2018	2023	Jeep	Wrangler JL	WJ2 Spare Tire Relocator	59-89005

FOOTNOTES: 1. Compatible With Up To A 37 Inch Spare Tire.

TRAILBLAZER PRODUCT

TRAILBLAZER ROCKER GUARDS

- » 2" Tube dimension
- » Available for 2 and 4 door Wranglers
- » Off-road styling

START	END	MAKE	MODEL
1987	2006	Jeep	Wrangler YJ & TJ ²

FINISH	PART NO.
Wrinkle Black	42-4005



FOOTNOTES: 2. Drilling required

WINCHES &
 ACCESSORIES
 PAGES 109-122

LED ROCK LIGHT KIT

TEXTURED BLACK

- » Includes 4 LED lights, rubber mounts, wiring harness and hardware
- » Rubber mounts include 4 flat and 4 angled
- » Wiring harness includes connector, switch, relay and in-line fuse
- » Water resistant connectors
- » Power output: 9W per LED light
- » Dust and moisture resistant lens
- » 9' direct fit wiring harness mounts on Jeep JL and JK undercarriage
- » 15' universal harness mounts on Westin WJ2 bumpers and universal applications.



FINISH: Textured Black Powder Coat
MATERIAL: Aluminum
WARRANTY: Limited Lifetime

INCLUDES 4
ROCK LIGHTS

4 FLAT
RUBBER MOUNTS

4 ANGLED
RUBBER MOUNTS

JEEP CUSTOM FIT
WIRING HARNESS

START	END	MAKE	MODEL	PART NO.
2007	2016	Jeep	Wrangler JK	09-0016
2018	2023	Jeep	Wrangler JL	09-0019
All	All	All	Includes lights (Set Of 4), 14 Ft. 9 in. Wiring Harness, And Switch.	09-0005

INNER FENDERS - FRONT

TEXTURED BLACK

- » Made of 16 gauge steel
- » Mesh covered openings to provide engine compartment ventilation
- » Protection from rocks and debris
- » Designed to fit with Westin's Front Tube Fenders
- » Sold in pairs (Set of 2)
- » Hardware included
- » Bolt-on installation - no drilling required*

*Minor trimming required when using front factory fenders



SOLD IN PAIRS (SET OF 2)



FINISH: Textured Black Powder Coat
MATERIAL: E-Coated Steel
WARRANTY: 3-Year

START	END	MAKE	MODEL	PART NO.
2020	2023	Jeep	Gladiator	62-11025
2007	2016	Jeep	Wrangler JK	62-11006
2016	2023	Jeep	Wrangler JL	62-11025

FOOTNOTES: 1. Trimming of front OE fender flare required

INNER FENDERS - REAR

TEXTURED BLACK

- » Made of 16 gauge steel
- » Protection from rocks and debris
- » Designed to fit with Westin's Rear Tube Fenders
- » Sold in pairs (Set of 2)
- » Hardware included

FINISH: Textured Black Powder Coat
MATERIAL: E-Coated Steel
WARRANTY: 3-Year



SOLD IN PAIRS (SET OF 2)



START	END	MAKE	MODEL	PART NO.
2007	2016	Jeep	Wrangler JK	62-11016
2016	2023	Jeep	Wrangler JL	62-11038

FOOTNOTES: 2. Requires Drilling. 3. Requires Trimming Of Passenger/Right Side Fender Liner.

WESTIN

JEEP® WRANGLER/GLADIATOR

FRONT AND REAR TUBE FENDERS

TEXTURED BLACK

- » Made of 1-gauge steel
- » Front fenders are 6 1/2" wide/Rear fenders are 5" wide
- » 1 1/2" diameter tube
- » .120" thick wall
- » Allows you to run bigger tires without a lift kit
- » Front tube fender includes side marker running lights
- » Sold in pairs
- » Mating seam is silicone sealed to prevent rust
- » Welded lip design keeps plastic inner fender in place
- » Fender welt included for a finished look
- » Bolt-on installation - no drilling required
- » Hardware included



2018-2022 JEEP
WRANGLER JL
FRONT TUBE FENDERS



2007-2018 JEEP
WRANGLER JK
FRONT TUBE FENDERS



2018-2022 JEEP
WRANGLER JL
REAR TUBE FENDERS



2007-2018 JEEP
WRANGLER JK
REAR TUBE FENDERS



START	END	MAKE	MODEL	FRONT	REAR
2020	2023	Jeep	Gladiator*	62-1025	62-1069
2007	2018	Jeep	Wrangler JK*	62-1005	62-1018
2018	2023	Jeep	Wrangler JL*	62-1025	62-1029

FOOTNOTES: * Drilling required

TRIPLE TUBE ROCK RAIL STEPS

TEXTURED BLACK

- » Protect rocker panels
- » 16-gauge steel top step plate
- » 2" diameter, 120" thick wall tube
- » Mount directly to vehicle frame
- » Coarse textured coated step area for slip resistance
- » Welded support plate with laser cut logo
- » Bolt-on installation - no drilling required
- » Available for 2 and 4 door applications

FINISH: Textured Black Powder Coat

MATERIAL: E-Coated Steel

WARRANTY: 3-Year



**COARSE TEXTURE
COATED STEP AREA FOR
SLIP RESISTANCE**

START	END	MAKE	APPLICATION	TEXTURED BLACK
2007	2018	Jeep	Wrangler JK 2Dr	42-6005
2007	2018	Jeep	Wrangler JK Unlimited 4Dr	42-6015
2018	2023	Jeep	Wrangler JL Unlimited 4Dr	42-6025

ROCK SLIDER STEPS

TEXTURED BLACK

- » Protect vehicle's rocker panels
- » Snug rocker and body mounting provides maximum clearance
- » Black plated stainless steel hardware
- » Fully functional step with minimal protrusion
- » Slip resistant textured coated steel step plates
- » Easy to clean removable step plates
- » Equipped with two off-road jack points
- » Available for 2 and 4 door applications

FINISH: Textured Black Powder Coat

MATERIAL: E-Coated Steel

WARRANTY: 3-Year



START	END	MAKE	APPLICATION	TEXTURED BLACK
2007	2018	Jeep	Wrangler JK Unlimited 4Dr 1, 3	42-7015

FOOTNOTES: 1. Drilling required 3. Excludes Vehicles With OEM Fender Flares.



Foam gaskets included to protect vehicle finish



PILLAR LIGHT MOUNT

- » Made of 7 gauge mild steel to sustain the weight of a 60" light bar*
- » Stainless steel fasteners for superior corrosion protection
- » Lower pillar light mounting points for single post lights*
- » Textured black finish complements factory vehicle trim
- » Foam gaskets included to protect vehicle finish
- » Bolt-on installation - no drilling required

FINISH: Textured Black Powder Coat
MATERIAL: E-Coated Steel
WARRANTY: 3-Year

START	END	MAKE	APPLICATION	PART NO.
2020	2023	Jeep	Gladiator (Excl. Mojave)(Excl. 4xe)	62-41085
2007	2018	Jeep	Wrangler JK	62-41035
2018	2023	Jeep	Wrangler JL (Excl. Rubicon 392)(Excl. 4xe)	62-41085

COWL MOUNT

SOLD IN SET OF 2



- » Designed to mount a 40" single row LED light bar*
- » Lightweight solid platform made of cast aluminum
- » Stainless steel fasteners for superior corrosion protection
- » Mounts directly to existing cowl bolt locations
- » Sold in set of 2
- » Textured black finish complements factory vehicle trim
- » Bolt-on installation - no drilling required

FINISH: Textured Black Powder Coat
MATERIAL: Cast Aluminum
WARRANTY: 3-Year

START	END	MAKE	APPLICATION	PART NO.
2007	2018	Jeep	Wrangler JK	62-41025
2007	2018	Jeep	Wrangler JK	62-41015
2018	2023	Jeep	Wrangler JL (Excl. Rubicon 392)(Excl. 4xe)	62-41075

LOWER PILLAR MOUNT

SOLD IN SET OF 2



- » Designed to mount post mount LED lights*
- » Lightweight solid platform made of cast aluminum
- » Sold in set of 2
- » Stainless steel fasteners for superior corrosion protection
- » Textured black finish complements factory vehicle trim
- » Cast with wire management channel
- » Bolt-on installation - no drilling required

FINISH: Textured Black Powder Coat
MATERIAL: Cast Aluminum
WARRANTY: 3-Year
*LED lights not included

START	END	MAKE	APPLICATION	PART NO.
2007	2018	Jeep	Wrangler JK	62-41045

BUMPER MOUNT 30" LED BAR

SOLD IN SET OF 2

- » Designed to mount a 30" LED light bar*
- » Design does not obstruct headlights
- » Textured black finish complements factory vehicle trim
- » Sold in set of 2
- » Bolt-on installation - no drilling required



FINISH: Textured Black Powder Coat
MATERIAL: E-Coated Steel
WARRANTY: 3-Year
Note: LED light bar not included

NOTE: Bumper filler panel trimming is required

START	END	MAKE	APPLICATION	PART NO.
2007	2018	Jeep	Wrangler JK	62-41065



Foam gaskets included to protect vehicle finish



OVERHEAD LIGHT HOOP

- » Stainless steel fasteners for superior corrosion protection
- » Side mount brackets to install 50" LED Bar*
- » Pre-drilled for wire management
- » Lower pillar light mounting points for single post lights*
- » Textured black finish complements factory vehicle trim
- » Foam gaskets included to protect vehicle finish
- » Bolt-on installation - no drilling required

FINISH: Textured Black Powder Coat
MATERIAL: E-Coated Steel
WARRANTY: 3-Year
*LED lights not included
NOTE: This product will interfere with opening and closing soft tops

START	END	MAKE	APPLICATION	PART NO.
2007	2018	Jeep	Wrangler JK*	62-41005

FOOTNOTES: 1. This product will interfere with opening and closing soft tops

HOOD MOUNT

SOLD IN SET OF 2



- » Designed to mount a 20" LED light bar*
- » Lightweight solid platform made of cast aluminum
- » Stainless steel fasteners for superior corrosion protection
- » Easily installs directly to existing hood hinge bolt locations
- » Sold in set of 2
- » Low profile design does not obstruct drivers view
- » Includes brackets to relocate windshield squirter
- » Textured black finish complements factory vehicle trim
- » Bolt-on installation - no drilling required



Squirter Re-locator kit included

FINISH: Textured Black Powder Coat
MATERIAL: Cast Aluminum
WARRANTY: 3-Year
Note: LED light bar not included

START	END	MAKE	APPLICATION	PART NO.
2007	2018	Jeep	Wrangler JK	62-41015

BUMPER MOUNT LIGHT BAR

- » Textured black finish complements factory vehicle trim
- » Light tabs mount up to (3) single post lights or (1) 20" LED Light Bar*
- » Design does not obstruct headlights
- » Bolt-on installation - no drilling required

NOTE: Bumper filler panel trimming is required.

FINISH: Textured Black Powder Coat
MATERIAL: E-Coated Steel
WARRANTY: 3-Year
*LED lights not included



START	END	MAKE	APPLICATION	PART NO.
2007	2018	Jeep	Wrangler JK	62-41055

JL AND JK SKID PLATES TEXTURED BLACK

- » Protects your Jeep's undercarriage from off-road hazards
- » Available for 2 door and 4 door Jeep Wranglers
- » Made of 3/16" steel - Textured black
- » Bolt-on installation - No-drilling required
- » Easy removal for repairs and servicing
- » Laser-cut openings to reduce weight
- » Mounting hardware included

FINISH: Textured Black Powder Coat
MATERIAL: E-Coated Steel
WARRANTY: 1-Year

GAS TANK SKID PLATE (2 DOOR)



GAS TANK SKID PLATE (4 DOOR)



EVAP CANISTER SKID PLATE



TRANSFER CASE SKID PLATE



OIL PAN TRANSMISSION SKID PLATE



MUFFLER SKID PLATE



START	END	MAKE	MODEL	PRODUCT	PART NO.
2012	2018	Jeep	Wrangler JK	Evap Skid Plate	42-21039
2016	2020	Jeep	Wrangler JL Unlimited 4Dr	Gas Tank Skid Plate	42-21115
2007	2016	Jeep	Wrangler JK 2Dr	Gas Tank Skid Plate	42-21005
2007	2018	Jeep	Wrangler JK Unlimited 4Dr	Gas Tank Skid Plate	42-21056
2007	2016	Jeep	Wrangler JK	Muffler Skid Plate	42-21048
2016	2020	Jeep	Wrangler JL	Muffler Skid Plate	42-21105
2020	2020	Jeep	Gladiator (Excl. Diesel & Turbo)	Oil Pan Skid Plate	42-21096
2012	2018	Jeep	Wrangler JK	Oil Pan Transmission Skid Plate	42-21015
2016	2020	Jeep	Wrangler JL 2Dr/Wrangler JL Unlimited 4Dr (Excl. 4xe, Diesel, Turbo, V6)	Oil Pan Skid Plate	42-21096
2007	2016	Jeep	Wrangler JK	Transfer Case Skid Plate	42-21026
2016	2020	Jeep	Wrangler JL	Transfer Case Skid Plate	42-21086
2007	2011	Jeep	Wrangler JK	Transmission Pan Skid Plate	42-21125
2016	2020	Jeep	Wrangler JL 3.6L V6 (Excl. Diesel, Manual Trans, Turbo)(Excl. 4xe)	Transmission Pan Skid Plate	42-21075

HDX DROP NERF STEP BARS

- » Die stamped steel step areas for maximum traction
- » Provides over 2 more inches of toe/heel step area than our competitors
- » Removable step plates for easy cleaning
- » Fits tight to rocker panel for a solid fit and rugged look
- » Solid 1-piece construction
- » Bolt-on installation – no drilling required
- » Mount kit included

FINISH: Textured Black Powder Coat
 MATERIAL: E-Coated Steel
 WARRANTY: 5-Year



START	END	MAKE	MODEL	TEXTURED BLACK
2020	2023	Jeep	Gladiator	56-14165
2007	2018	Jeep	Wrangler JK 2Dr	56-13315
2007	2018	Jeep	Wrangler JK Unlimited 4Dr	56-13295
2016	2023	Jeep	Wrangler JL 2Dr	56-14055
2016	2023	Jeep	Wrangler JL Unlimited 4Dr	56-14065

HDX STAINLESS DROP NERF STEP BARS

- » Built with corrosion resistant, black powder-coated stainless steel
- » Die stamped stainless steel step areas for maximum traction
- » Includes stainless steel step plates
- » Rust resistant step plates
- » Fits tight to rocker panel for a solid fit and rugged look
- » Solid 1-piece construction
- » Bolt-on installation – no drilling required
- » Mount kit included

FINISH: Textured Black Powder Coat
 MATERIAL: 410 Stainless Steel
 WARRANTY: 5-Year



START	END	MAKE	MODEL	TEXTURED BLACK
2020	2023	Jeep	Gladiator	56-14165
2007	2018	Jeep	Wrangler JK 2Dr	56-13315
2007	2018	Jeep	Wrangler JK Unlimited 4Dr	56-13295
2016	2023	Jeep	Wrangler JL 2Dr	56-14055
2016	2023	Jeep	Wrangler JL Unlimited 4Dr	56-14065

NEW! OUTLAW DROP NERF STEP BARS

- » Stylized step with premium features at an affordable price
- » Constructed of 1.5" diameter mandrel bent steel tube
- » Distinctive 4" drop die-stamped step plate provides maximum traction while cleaning dirt, mud, and debris

FINISH: Textured Black Powder Coat
 MATERIAL: E-Coated Steel
 WARRANTY: 3-Year



START	END	MAKE	MODEL	TEXTURED BLACK
2020	2023	Jeep	Gladiator	20-14165
2007	2018	Jeep	Wrangler JK Unlimited 4Dr	20-13295
2016	2023	Jeep	Wrangler JL Unlimited 4Dr	20-14065

R5 NERF STEP BARS

- » Mount kit included
- » Injection molded polymer step pad
- » 5" wide step area
- » Triangular internal board design conceals brackets for a clean look
- » Injection molded bracket covers included - on some applications
- » Optional light kit for end caps (part no. 28-51003)

FINISH: Textured Black Powder Coat
 MATERIAL: Aluminum
 WARRANTY: 3 Year



START	END	MAKE	MODEL	TEXTURED BLACK
2020	2023	Jeep	Gladiator	20-51325
2016	2023	Jeep	Wrangler JL Unlimited 4Dr	20-51315

PRO TRAXX 4 & 5 OVAL NERF STEP BARS

- » 4" or 5" oval tube
- » 30° OE style bends
- » Bold step pad design
- » Seamless domed ends
- » Bolt-on installation – no drilling required

FINISH: Polished
 MATERIAL: 304 Stainless Steel
 WARRANTY: Lifetime



START	END	MAKE	MODEL	SIZE	MTNG	POLISHED	BLACK
2020	2023	Jeep	Gladiator	4"	Rocker Pnl	21-24165	21-24165
2007	2018	Jeep	Wrangler JK 2Dr	4"	Rocker Pnl	21-23315	21-23315
2007	2018	Jeep	Wrangler JK Unlimited 4Dr	4"	Rocker Pnl	21-23295	21-23295
2016	2023	Jeep	Wrangler JL 2Dr	4"	Rocker Pnl	21-24055	21-24055
2016	2023	Jeep	Wrangler JL Unlimited 4Dr	4"	Rocker Pnl	21-24065	21-24065
2020	2023	Jeep	Gladiator	5"	Rocker Pnl	21-54165	21-54165
2016	2023	Jeep	Wrangler JL Unlimited 4Dr	5"	Rocker Pnl	21-54065	21-54065

OUTLAW NERF STEP BARS

- » 2" diameter wall tubing for maximum durability
- » 16 gauge steel top step surface
- » Protects vehicle rocker panels from potential damage
- » Coarse textured step area for slip resistance
- » Unique dimple stamped top plate
- » Bolt-on installation – no drilling required

FINISH: Textured Black Powder Coat
 MATERIAL: E-Coated Steel
 WARRANTY: 3-Year



START	END	MAKE	MODEL	TEXTURED BLACK
2020	2023	Jeep	Gladiator	58-54165

PLATINUM 4 OVAL NERF STEP BARS

- » OE style oval tube steps
- » 90° mandrel bends
- » 4" wide step pad
- » Recessed step area
- » Bolt-on installation – no drilling required*

FINISH: Polished
 MATERIAL: 304 Stainless Steel
 WARRANTY: Lifetime

FINISH: Textured Black Powder Coat
 MATERIAL: E-Coated Steel
 WARRANTY: 3-Year



START	END	MAKE	MODEL	MTNG	POLISHED	BLACK
2020	2023	Jeep	Gladiator	Rocker Pnl	—	21-4165
2007	2018	Jeep	Wrangler JK 2Dr	Rocker Pnl	—	21-3315
2016	2023	Jeep	Wrangler JL Unlimited 4Dr	Rocker Pnl	—	21-4065

PREMIER 4 OVAL NERF STEP BARS

- » Mount kit sold separately
- » 4" oval tube
- » Injection molded polymer step pad
- » Molded oval end caps
- » Bolt-on installation – no drilling required

FINISH: Polished
 MATERIAL: 304 Stainless Steel
 WARRANTY: Lifetime

FINISH: Black Powder Coat
 MATERIAL: E-Coated Steel
 WARRANTY: 3-Year



START	END	MAKE	MODEL	MTNG	LENGTH	POLISHED	BLACK	REQUIRED MOUNT KIT
2007	2018	Jeep	Wrangler JK 2Dr	Prime	53"	22-5000	22-5005	22-1725
2007	2018	Jeep	Wrangler JK Unlimited 4Dr	Prime	72"	22-5050	22-5055	22-1725

E-SERIES 3 NERF STEP BARS

- » Mount kit included
- » 3" round step bars
- » Economical step-up solution
- » Vehicle specific applications
- » Injection molded polymer step pad
- » Recessed step area
- » Bolt-on installation - no drilling required



FINISH: Polished
MATERIAL: 304 Stainless Steel
WARRANTY: Lifetime

FINISH: Black Powder Coat
MATERIAL: E-Coated Steel
WARRANTY: 3-Year

START	END	MAKE	MODEL	POLISHED	BLACK
2007	2018	Jeep	Wrangler JK 2Dr	-	23-3215
2007	2018	Jeep	Wrangler JK Unlimited 4Dr	-	23-3295
2016	2023	Jeep	Wrangler JL Unlimited 4Dr	-	23-4065
1997	2006	Jeep	Wrangler TJ (Excl. 2004-2005 Unlimited)	23-0970	23-0975

SIGNATURE 3 NERF STEP BARS

- » 4" upper oval tube
- » Drop step is made of 2" oval tube
- » Textured step pad
- » Welded and sealed tube ends
- » Rocker panel mounted
- » U.S. Patent No. 6588793, 6874801



FINISH: Chrome
MATERIAL: E-Coated Steel
WARRANTY: 3-Year

FINISH: Black Powder Coat
MATERIAL: Galvanized Steel
WARRANTY: 5-Year

START	END	MAKE	MODEL	MTNG	POLISHED	BLACK
2004	2006	Jeep	Wrangler Unlimited	Frame Mnt	-	23-2855
1997	2006	Jeep	Wrangler TJ (Excl. Unlimited)	Frame Mnt	-	23-0975

HDX XTREME NERF STEP BARS

- » Mount kit included
- » Oversized step areas for easier cab entry and exit
- » Injection molded polymer step pad
- » Solid 1-piece construction
- » Textured black powder coat finish



FINISH: Textured Black Powder Coat
MATERIAL: E-Coated Steel
WARRANTY: 3-Year

START	END	MAKE	MODEL	TEXTURED BLACK
2020	2025	Jeep	Gladiator	56-24165
2007	2018	Jeep	Wrangler JK 2Dr	56-23316
2007	2018	Jeep	Wrangler JK Unlimited 4Dr	56-23295
2016	2023	Jeep	Wrangler JL 2Dr	56-24055
2018	2023	Jeep	Wrangler JL Unlimited 4Dr	56-24075

PREMIER 6 OVAL NERF STEP BARS

- » Vehicle specific mounting kit required - sold separately
- » 4" oval tube
- » Cradle mounted tubes
- » Injection molded polymer step pad
- » Molded oval end caps
- » Bolt-on installation - no drilling required



FINISH: Polished
MATERIAL: 304 Stainless Steel
WARRANTY: Lifetime

FINISH: Textured Black Powder Coat
MATERIAL: E-Coated Steel
WARRANTY: 3-Year

START	END	MAKE	MODEL	MTNG	LENGTH	POLISHED	BLACK	REQUIRED MOUNT KIT
2007	2018	Jeep	Wrangler JK 2Dr	Frame	53"	22-6000	22-6005	22-1725

MAX[®] WESTIN[®] EASY 3 STEP SYSTEM

WINCH MOUNTING SYSTEM

1. MAX TRAY (BASE UNIT)



- » Mount kit included
- » Winch trays rated up to 9,500 lbs.
- » Features Tow Hooks notches (46-3005 - 2 needed)
- » Patent Pending

2. MAX BULL BAR/LIGHT BAR



- » Mounts directly to MAX Winch Tray
- » Made of 3" tube
- » Wrinkle black powder coat finish
- » No-drill installation
- » Pre-drilled for wire management

3. SX 10SR SYNTHETIC ROPE



WINCH TRAY AND BULLLIGHT BAR

FINISH: Wrinkle Black Powder Coat
MATERIAL: E-Coated Steel
WARRANTY: 3-Year

- » Rated line pull of 10,000 lbs.
- » 5.5 HP sealed motor
- » Relocatable die-cast aluminum control box
- » Includes wireless handheld remote & 12' handheld wired remote
- » Pull-and-turn clutch handle
- » 3-stage planetary gearing with 216:1 ratio
- » Patented drumlight
- » Synthetic rope measures 3/8" x 80'
- » Heavy duty clevis winch hook
- » Aluminum hawse fairlead
- » 100% full load holding automatic mechanical brake
- » • IP68-rated waterproof and dustproof winch
- » • Durable metallic graphite powder coat finish

MECHANICAL WARRANTY: Limited Lifetime
ELECTRONIC WARRANTY: Limited 7-Year

TOW HOOK (1 UNIT PER PACKAGE)

- » Maximum load rating 12,000 lbs.
- » Finish: Black.



➔ PN# 46-3005

MAX[®]

START	END	MAKE	MODEL	WEIGHT CAPACITY	FINISH	BLACK BB/LB	WINCH TRAY
2020	2025	Jeep	Gladiator [®]	9,500 lbs.	Wrinkle Black	-	46-23925
2007	2018	Jeep	Wrangler JK [™]	9,500 lbs.	Wrinkle Black	46-43635	-
2016	2023	Jeep	Wrangler JL [™]	9,500 lbs.	Wrinkle Black	-	46-23925

FOOTNOTES: 1 Lights mount to Winch Tray. 2 Requires Trimming Lower Bumper Grille On 2010-2015 Vehicles.

WESTIN

JEEP® WRANGLER/GLADIATOR

LED HOOD SCOOPS TEXTURED BLACK

- Designed exclusively for Jeep Wrangler/Gladiator
- Includes two 5" LED vented hood scoops, two gaskets, wiring harness and hardware
- Constructed of 14 gauge steel
- Flood beam pattern enhances visibility in inclement weather or darkness
- 14' wiring harness includes connector, switch, relay and in-line fuse
- Includes laser-cut Westin logo
- E-coated base coat provides long lasting corrosion protection

FINISH: Textured Black Powder Coat
MATERIAL: Steel
WARRANTY: 3-Year
LED WARRANTY: 1 Year

- Raw lumens: 1600
- Power output: 18W per LED light
- Dust and moisture resistant lens
- Allows hot air to escape from the engine bay
- Gaskets protect paint surface
- Available in textured black finish
- Bolt-on installation - no drilling required



START	END	MAKE	MODEL	TEXTURED BLACK
2020	2023	Jeep	Gladiator (Excl. North, Overland, Sport, & Sport S)	62-41115
2018	2023	Jeep	Wrangler JL 2Dr (Excl. Sahara, Sport, & Sport S)	62-41115
2018	2023	Jeep	Wrangler JL Unlimited 4Dr (Excl. Sahara, Sport, & Sport S)	62-41115

BODY TRIM ACCESSORIES

PROFILE FLOOR & CARGO LINERS

START	END	MODEL	PIECE	POSITION	PART NO.
2020	2023	Gladiator	2	Front Row	74-21-11008
2007	2018	Wrangler JK ⁴	2	Front Row	74-21-21005
2007	2018	Wrangler JK Unlimited ⁴	4	Front & 2nd Row	74-21-41007
2018	2023	Wrangler JL 2Dr	2	Front Row	74-21-11008
2018	2023	Wrangler JL Unlimited 4Dr	2	Front Row	74-21-11008
2018	2023	Wrangler JL Unlimited 4Dr	1	Cargo	74-21-41010

FOOTNOTES: 8. Excl. models w/ factory slide-out factory cargo tray

SURE FIT FLOOR LINERS

START	END	MODEL	POSITION	BLACK
2020	2023	Gladiator	Front	72-51460
2018	2023	Wrangler JL/Wrangler JL Unlimited	Front	72-51462
2011	2018	Wrangler Unlimited 16 (Excl. 2018 JL)	Cargo	72-517068

FOOTNOTES: 1. Trimming required for use with factory subwoofer

PLATINUM BUG SHIELD

START	END	MODEL	SMOKE	CLEAR
2018	2021	Wrangler JL Unlimited 4Dr (Excl. 2018 JK) 1	72-90152	-
2007	2018	Wrangler/Wrangler Unlimited (Excl. 2018 JK) 1	72-90150	-

FOOTNOTES: 1. Requires Drilling.

TAPE ON WIND DEFLECTORS

START	END	MODEL	2-PIECE	4-PIECE
1997	2006	Wrangler	72-51460	-
2018	2023	Wrangler JL (Excl. 2018 JK)	72-51468	-
2018	2023	Wrangler JL Unlimited 4Dr (Excl. 2018 JK)	-	72-51404
2007	2018	Wrangler/Wrangler unlimited (Excl. JL 2018)	-	72-51496

IN CHANNEL WIND DEFLECTORS

START	END	MODEL	2-PIECE	4-PIECE
2020	2023	Gladiator	-	72-51499
2007	2018	Wrangler JK 2Dr	72-51465	-
2007	2018	Wrangler JK Unlimited 4Dr	-	72-51495
2018	2023	Wrangler JL 2Dr	72-51467	-
2018	2023	Wrangler JL Unlimited 4Dr	-	72-51499



Ultimate LED Bull Bar 104



Ultimate Bull Bar 105



E-Series Bull Bar 106



Safari Bull Bar 107

WESTIN

BULL BARS

ULTIMATE LED BULL BAR

TEXTURED BLACK / CHROME

- ▶ Mount kit included
- ▶ Made of 3" tube
- ▶ Molded bushings for a finished look
- ▶ Includes 20" combo beam LED light bar
- ▶ Wiring harness included
- ▶ Clean-cut opening with weather strip seal
- ▶ Brushed stainless steel skid plate features laser cut Westin logo
- ▶ Bolt-on installation - no drilling required*

*Minor cutting of fascia may be required

FINISH: Chrome

MATERIAL: 304 Stainless Steel

WARRANTY: Lifetime

LED WARRANTY: Limited Lifetime

FINISH: Textured Black Powder Coat

MATERIAL: Galvanized Steel

WARRANTY: 3-Year

LED WARRANTY: Limited Lifetime

LED LIGHT BAR INCLUDED

- ▶ 3 Watt LED chips
- ▶ Power Output: 45 watts
- ▶ Raw Lumens: 4,050



START	END	MAKE	MODEL	STAINLESS	TEXTURED BLACK
2016	2018	Chevrolet	Silverado 1500 ^{1,2,3,4,5}	—	32-3075L
2019	2021	Chevrolet	Silverado 1500 (Excl. 2019 LD) ^{6,7,8,9}	32-3950L	32-3955L
2022	2022	Chevrolet	Silverado 1500 LTD ^{1,4,5,9}	32-3950L	32-3955L
2020	2020	Chevrolet	Silverado 2500/3500 ^{1,4,5}	—	32-3990L
2019	2019	Chevrolet	Silverado LD ^{1,4,5,7}	—	32-3075L
2009	2018	Dodge	Ram 1500 (Excl. Rebel & Warlock) ^{1,4,5,9}	32-1960L	32-1965L
2010	2014	Ford	Expedition EL ^{1,4,5}	—	32-2405L
2009	2014	Ford	F-150 (Excl. Harley Davidson, Limited, & Raptor) ^{1,7,8,9,10}	—	32-2405L
2015	2023	Ford	F-150 (Excl. 2022+ Lightning EV & 2017+ Raptor) ^{1,4,5,9}	—	32-2455L
2017	2022	Ford	F-250/350 ^{1,4,5,9,10,11}	32-3900L	32-3908L
2019	2022	Ford	Ranger ^{1,4,5,9,10,11,22}	32-3910L	32-3915L
2009	2022	Lincoln	Navigator L ^{4,5,9,10}	—	32-2405L
2009	2018	Ram	1500 (Excl. Rebel & Warlock) ^{1,4,5,9}	32-1960L	32-1965L
2019	2021	Ram	1500 (Excl. Classic) (Excl. Rebel, TRX, & Warlock) ^{1,4,5,11,12}	—	32-3975L
2019	2023	Ram	1500 Classic (Excl. Rebel, TRX, & Warlock) ^{1,4,5,11}	32-1960L	32-1965L
2019	2023	Ram	2500/3500 ⁴	—	32-4025L
2010	2023	Toyota	4Runner (Excl. Nightshade, TRD Sport, & 2014+ Limited) ^{1,4}	—	32-3605L
2008	2022	Toyota	Sequoia ¹	32-2250L	32-2255L
2005	2015	Toyota	Tacoma ¹	32-1600L	32-1605L
2016	2023	Toyota	Tacoma ^{1,4}	32-3880L	32-3885L
2007	2021	Toyota	Tundra ^{1,4,5,11}	32-2250L	32-2255L

FOOTNOTES: 1. Requires Cutting The Air Dam/Bumper Valance. 2. Factory Tow Hooks Cannot Be Reused. 3. Requires Minor Cutting Of Air Dam/Bumper Valance On Vehicles Without Tow Hooks. 4. Requires Removal Of Skid Plate If Equipped. 5. Requires Minor Trimming Of Tow Hook Pockets. 7. Use License Plate Relocator Part # 32-0055 (Sold Separately) For EcoBoost Vehicles. 8. Excludes models with "Adaptive Cruise (speed) Control", or forward collision warning systems that feature grille mounted laser control sensors. 9. Requires Trimming Lower Bumper Grille On 2010-2012 Vehicles. 10. May interfere with function of front parking sensor if equipped. 11. May Interfere With Camera If Equipped. 13. Will Partially Block Airflow To Intercooler On EcoBoost Vehicles. 15. Requires Trimming Plastic Cover Near Bracket Gusset. 16. Requires Cutting The Air Dam/Bumper Valance. 17. Requires Trimming Of Plastic Behind Bumper On Sport And Express Models. 18. Will interfere with block heater plug. 19. Will Interfere With Adaptive Cruise (Speed) Control If Equipped. 20. Will Interfere With Or Obstruct View Of License Plate. 21. Excludes Vehicles With Skid Plate. 22. Requires License Plate Relocator Part # 32-0055 (Sold Separately). 23. Excludes Vehicles With Forward Collision Warning Systems That Feature Grille Mounted Laser Control Sensors. 25. Will Interfere With Parking Sensor If Equipped.

ULTIMATE BULL BAR

CHROME 304 STAINLESS STEEL / BLACK POWDER COAT

- » Mount kit included
- » Vehicle specific applications for perfect fit
- » Brushed stainless steel skid plate features laser cut Westin logo
- » 2 1/2" tube for compact trucks and SUVs
- » 3" tube for full-sized trucks and SUVs
- » 20" LED light mounting brackets (part no. 32-0045) - sold separately
- » Molded transition bushings
- » 2 light mounting points on the top of center bar



FINISH: Chrome

MATERIAL: 304 Stainless Steel

WARRANTY: Lifetime

FINISH: Black Powder Coat

MATERIAL: E-Coated Steel

WARRANTY: 5-Year

START	END	MAKE	MODEL	CHROME	BLACK
2001	2006	Chevrolet	Avalanche 1500 ^{1,4}	—	32-1175
2002	2006	Chevrolet	Avalanche 2500 ^{1,4}	—	32-1245
1992	1994	Chevrolet	Biazer (Full Size) ^{1,4}	—	32-0085
1998	1999	Chevrolet	C/K Series 1500 ^{1,4}	—	32-0085
1993	2000	Chevrolet	C/K Series 2500/3500HD ^{1,4,5}	—	32-0085
2016	2022	Chevrolet	Colorado	—	32-3645
2001	2007	Chevrolet	Silverado "Classic" 1500HD/2500/3500HD (Excl. SS) ^{1,4}	—	32-1245
2007	2010	Chevrolet	Silverado 1500 (Excl. Classic)	—	32-2275
2016	2021	Chevrolet	Silverado 1500 (Excl. 2019 LD) ^{1,2,3,4}	32-3960	32-3965
2002	2002	Chevrolet	Silverado 1500 LTD ^{1,2,3,4}	32-3960	32-3965
1999	2004	Chevrolet	Silverado 2500LD (Excl. SS) ^{1,4}	—	32-1245
2000	2003	Chevrolet	Silverado 2500/3500 ^{1,2,3,4}	—	32-3995
1995	1999	Chevrolet	Suburban (All) ^{1,4}	—	32-0095
2000	2005	Chevrolet	Suburban 1500 ^{1,4}	—	32-1175
2000	2005	Chevrolet	Suburban 2500 ^{1,4}	—	32-1245
1995	1999	Chevrolet	Tahoe ^{1,4}	—	32-0085
2000	2005	Chevrolet	Tahoe 1500 ^{1,4}	—	32-1175
2000	2005	Chevrolet	Tahoe 2500 ^{1,4}	—	32-1245
2011	2013	Dodge	Durango ^{1,4}	—	32-3585
2009	2010	Dodge	Ram 1500 (Excl. Rebel & Warlock) ^{1,2,3,4}	—	32-1965
2016	2021	Ford	F-150 (Excl. 2017+ Raptor) ^{1,2,3,4}	—	32-2455
2004	2005	Ford	F-150 249HD (Excl. 2004 Heritage)(Excl. Harley Davidson) ^{1,4}	—	32-1395
2019	2022	Ford	Ranger ^{1,2,3,4,5,6,7,8}	—	32-3985
1998	1999	GMC	C/K Series 1500 ^{1,4}	—	32-0085
2016	2022	GMC	Canyon	—	32-3645
1992	1994	GMC	Jimmy (Full Size) ¹	—	32-0085
2001	2007	GMC	Sierra "Classic" 1500HD/2500/3500HD ^{1,4}	—	32-1245
1999	2007	GMC	Sierra "Classic" 1500LD ^{1,4}	—	32-1175
1999	2004	GMC	Sierra "Classic" 2500LD ^{1,4}	—	32-1245
2007	2010	GMC	Sierra 1500 (Excl. Denali) (Excl. Classic)	—	32-2275
2016	2018	GMC	Sierra 1500	—	32-3925
2019	2019	GMC	Sierra 1500 Limited	—	32-3925
1995	1999	GMC	Yukon ¹	—	32-0085
2000	2005	GMC	Yukon/Yukon XL 1500 (Excl. Denali) ^{1,4}	—	32-1175
2000	2005	GMC	Yukon/Yukon XL 2500 (Excl. Denali) ^{1,4}	—	32-1245
2011	2015	Jeep	Grand Cherokee ^{1,2,3,4}	—	32-3885
2005	2008	Lincoln	Mark LT ¹	—	32-1395
2005	2017	Nissan	Frontier ^{1,4}	—	32-1690
2005	2007	Nissan	Pathfinder ^{1,4}	—	32-1690
2005	2015	Nissan	Xterra ¹	—	32-1690
2019	2023	Ram	2500/3500 ¹	—	32-4025
2019	2023	Ram	1500 (Excl. Classic)(Excl. Rebel, TRX, & Warlock) ^{1,2,3,4,5}	—	32-3975
2009	2010	Ram	1500 (Excl. Rebel & Warlock) ^{1,2,3,4}	—	32-1965
2019	2023	Ram	1500 Classic (Excl. Rebel, TRX, & Warlock) ^{1,2,3,4,5}	—	32-1965
2010	2023	Toyota	4Runner (Excl. Nightshade, TRD Sport, & 2014+ Limited) ^{1,2,3}	—	32-3605
2005	2014	Toyota	FJ Cruiser ¹	—	32-2215
2001	2007	Toyota	Sequoia ¹	—	32-1365
2003	2002	Toyota	Sequoia ¹	—	32-2255
2005	2015	Toyota	Tacoma ¹	—	32-1605
2016	2023	Toyota	Tacoma ¹	—	32-3885
1999	2005	Toyota	Tundra ¹	—	32-1365
2007	2021	Toyota	Tundra ^{1,2,3,4,5}	—	32-2255

FOOTNOTES: 1. Requires Cutting The Air Dam/Bumper Valance. 3. Factory Tow Hooks Cannot Be Reused. 6. Requires Cutting The Air Dam/Bumper Valance On 2WD Vehicles. 7. Requires Minor Cutting Of Air Dam/Bumper Valance On Vehicles Without Tow Hooks. 8. May Require Minor Trimming Of Air Dam/Bumper Valance. 11. Requires Removal Of Skid Plate If Equipped. 14. Requires Minor Trimming Of Tow Hook Pockets. 19. Excludes Platinum Edition Model With Parking Sonar/Aid System. 21. Use License Plate Relocator Part # 32-0065 (Sold Separately) For EcoBoost Vehicles. 22. Excludes Vehicles With Adaptive Cruise (Speed) Control If Equipped. 23. Requires Trimming Lower Bumper Grille On 2010-2012 Vehicles. 24. May Interfere With Function Of Parking Sensor If Equipped. 25. May Interfere With Camera If Equipped. 28. Will Partially Block Airflow To Intercooler On EcoBoost Vehicles. 32. Requires Cutting The Air Dam/Bumper Valance. 33. Requires Trimming Of Plastic Behind Bumper On Sport And Express Models. 34. Will Interfere With Block Heater Plug. 35. Will Interfere With Adaptive Cruise (Speed) Control If Equipped. 36. Will Interfere With Or Obstruct View Of License Plate. License Relocator Needed To Make Visible. 37. Excludes Vehicles With OEM Skid Plate. 38. Use License Plate Relocator Part # 32-0055 (Sold Separately). 39. Excludes Vehicles With Forward Collision Warning Systems That Feature Grille Mounted Laser Control Sensors If Equipped.

WESTIN[®] BULL BARS

E-SERIES BULL BAR

304 STAINLESS STEEL / BLACK POWDER COAT

- » Mount kit included
- » Made of 3" diameter stainless steel tubing
- » Stainless bull bar comes with brushed skid plate and laser cut Westin logo
- » Black bull bar comes with textured black skid plate and laser cut Westin logo
- » 20" LED light mounting brackets (part no. 32-0045) - sold separately
- » Fully welded cross tube
- » 2 light mounting points on center bar
- » Optional license plate re-locator available - sold separately

FINISH: Polished
MATERIAL: Aluminum
WARRANTY: Lifetime

FINISH: Black Powder Coat
MATERIAL: E-Coated Steel
WARRANTY: 3-Year



START	END	MAKE	MODEL	STAINLESS	BLACK
2002	2006	Chevrolet	Avalanche 1500 ¹	31-5170	31-5175
2002	2008	Chevrolet	Avalanche 2500 ¹	31-6240	—
2015	2022	Chevrolet	Colorado	31-5120	—
2007	2013	Chevrolet	Silverado 1500 ^{1,4,5,6}	31-5270	31-5275
2014	2015	Chevrolet	Silverado 1500 ^{1,4,5}	31-5900	31-5905
2016	2018	Chevrolet	Silverado 1500 ^{1,4,5}	31-6010	31-6015
2019	2021	Chevrolet	Silverado 1500 (Excl. 2019 LD) ^{1,4,5,6}	31-3960	31-3965
2022	2022	Chevrolet	Silverado 1500 LTD ^{1,4,5,6}	31-3960	31-3965
1999	2007	Chevrolet	Silverado "Classic" 1500LD (Excl. 65) ^{1,4}	31-5170	31-5175
2020	2022	Chevrolet	Silverado 2500/3500 ^{1,4,5}	31-6020	31-6025
2015	2019	Chevrolet	Silverado 2500/3500HD ^{1,4,5}	31-5630	—
1999	2007	Chevrolet	Silverado "Classic" 2500LD (Excl. 65) ^{1,4}	31-6240	—
2001	2007	Chevrolet	Silverado "Classic" 1500/2500/3500HD (Excl. 65) ^{1,4}	31-5240	—
2019	2019	Chevrolet	Silverado LD ^{1,4,5}	31-6010	31-6015
2015	2020	Chevrolet	Suburban/Tahoe ^{1,4,5,6}	31-5130	—
2000	2006	Chevrolet	Suburban/Tahoe 1500 ^{1,4}	31-5170	31-5175
2000	2006	Chevrolet	Suburban/Tahoe 2500 ^{1,4}	31-5240	—
2006	2008	Dodge	Ram 1500 (Excl. Hell-Sport, Mega Cab, Power Wagon) ^{1,4,5}	31-5960	—
2009	2018	Dodge	Ram 1500 (Excl. Rebel, TRX, & Warlock) ^{1,4}	31-5960	31-5965
2010	2018	Dodge	Ram 2500/3500 ⁴	31-5950	31-5955
2009	2014	Ford	F-150 (Excl. Harley Davidson, Limited, & Raptor) ^{1,4,5,6}	31-5490	31-5495
2015	2023	Ford	F-150 (Excl. 2022+ Lightning EV & 2017+ Raptor) ^{1,4,5,6,7}	31-5990	—
2017	2022	Ford	F-250/350 ^{1,4,5}	31-5900	31-5905
2011	2016	Ford	F-250/350/450/550 Super Duty ⁴	31-5370	—
2019	2022	Ford	Ranger ^{1,4,5,6,7,8}	31-3980	31-3985
2015	2022	GMC	Canyon	31-5120	—
2007	2013	GMC	Sierra 1500 (Excl. Denali) ^{1,4}	31-5270	31-5275
2014	2016	GMC	Sierra 1500 ^{1,4,5}	31-5900	31-5905
2016	2018	GMC	Sierra 1500	31-6010	31-6015
2019	2019	GMC	Sierra 1500 Limited	31-6010	31-6015
1999	2007	GMC	Sierra "Classic" 1500LD ^{1,4}	31-5170	31-5175
2001	2007	GMC	Sierra "Classic" 1500HD/2500/3500HD ^{1,4}	31-6240	—
2015	2019	GMC	Sierra 2500/3500HD ^{1,4,5}	31-5630	—
1999	2007	GMC	Sierra "Classic" 2500LD ^{1,4}	31-6240	—
2000	2006	GMC	Yukon/Yukon XL 1500 (Excl. Denali) ^{1,4}	31-5170	31-5175
2000	2006	GMC	Yukon/Yukon XL 3/4-Ton (Excl. Denali) ^{1,4}	31-6240	—
2022	2023	Nissan	Frontier	31-6035	—
2009	2018	Ram	1500 (Excl. Rebel & Warlock) ^{1,4}	31-5960	31-5965
2019	2022	Ram	1500 (Excl. Classic/Excl. Rebel, TRX, & Warlock) ^{1,4,5}	31-3970	31-3975
2019	2023	Ram	1500 Classic (Excl. Rebel, TRX, & Warlock) ^{1,4}	31-5960	31-5965
2010	2018	Ram	2500/3500 ⁴	31-5950	31-5955
2019	2022	Ram	2500/3500	31-4020	31-4025
2010	2023	Toyota	4Runner (Excl. Nightshade, TRD Sport, & 2014+ Limited) ^{1,4,5}	31-5610	31-5615
2008	2022	Toyota	Sequoia ⁴	31-6250	31-6255
2005	2015	Toyota	Tacoma ¹	31-5600	31-5605
2016	2021	Toyota	Tacoma ^{1,4}	31-6000	31-6005
2007	2021	Toyota	Tundra ^{1,4,5,6}	31-5250	31-5255

FOOTNOTES: 1. Requires Cutting The Air Dam/Bumper Valance. 3. Requires Removal Of Tow Hooks If Equipped. 4. Requires Cutting The Air Dam/Bumper Valance On 2WD Vehicles. 5. Requires Minor Cutting Of Air Dam/Bumper Valance On Vehicles Without Tow Hooks. 6. Minor Trimming Of Air Dam/Bumper Valance May Be Required. 7. Requires Removal Of Skid Plate If Equipped. 8. May Obstruct View Of License Plate. 12. Use License Plate Relocator Part # 32-0065 (Sold Separately) For EcoBoost Vehicles. 13. Excludes Vehicles With Adaptive Cruise (Speed) Control If Equipped. 14. Requires Trimming Lower Bumper Grille On 2010-2012 Vehicles. 15. May Interfere With Function Of Parking Sensor If Equipped. 16. Factory Tow Hooks Cannot Be Reused. 19. Will Interfere With Camera Sensor If Equipped. 21. Will Partially Block Airflow To Intercooler On EcoBoost Vehicles. 23. Requires Cutting The Air Dam/Bumper Valance. 24. Excludes Vehicles With "Lane Departure Distance Module" If Equipped. 25. Requires Minor Trimming Of Tow Hook Pockets. 26. Will Interfere With Block Heater Plug. 27. Will Interfere With Adaptive Cruise (Speed) Control If Equipped. 28. Excludes Vehicles With OEM Skid Plate. 29. Excludes Vehicles With Forward Collision Warning Systems That Feature Grille Mounted Laser Control Sensors If Equipped. 30. Use License Plate Relocator Part # 32-0055 (Sold Separately). 35. Will Interfere With Parking Sensor If Equipped.

SAFARI BULL BAR

304 STAINLESS STEEL / BLACK POWDER COAT

- » Vehicle specific mount kit required - sold separately
- » 2" tube
- » Universal bars
- » Welded light mounting tabs

FINISH: Polished
 MATERIAL: 304 Stainless Steel
 WARRANTY: Lifetime

FINISH: Black Powder Coat
 MATERIAL: E-Coated Steel
 WARRANTY: 3-Year



START	END	MAKE	MODEL	BLACK	MOUNT KIT
2003	2006	Acura	MDX	30-0005	30-1256
2004	2007	Buick	Rainier	30-0025	30-1345
1998	2004	Chevrolet	Blazer Downsize	30-0005	30-1065
2005	2009	Chevrolet	Equinox ⁴	30-0025	30-1079
1998	2004	Chevrolet	S-Series Pickup (incl. ZR2 Sonoma High Rider)	30-0005	30-1065
1999	2004	Chevrolet	Tracker	30-0025	30-1079
2002	2009	Chevrolet	Traillazer	30-0025	30-1345
1997	2004	Dodge	Dakota	30-0005	30-1006
1998	2003	Dodge	Durango	30-0005	30-1006
2001	2007	Ford	Escape ⁷	30-0025	30-1155
1998	2001	Ford	Explorer (Excl. 2002 Body Sold In 2001)	30-0005	30-1055
2002	2005	Ford	Explorer 4Dr	30-0025	30-1155
2001	2004	Ford	Explorer Sport 2Dr	30-0005	30-1145
2001	2005	Ford	Explorer Sport Trac	30-0005	30-1145
1998	2000	Ford	Ranger (Excl. 2000 W/ Off-Road Pkg.) ⁴	30-0005	30-1055
2001	2008	Ford	Ranger Edge (Excl. STX) ⁴	30-0025	30-1165
2002	2005	GMC	Envoy	30-0025	30-1345
1998	2002	GMC	Jimmy Downsize	30-0005	30-1065
1998	2004	GMC	S-Series Pickup (incl. ZR2 Sonoma High Rider)	30-0005	30-1065
1997	2001	Honda	CR-V	30-0005	30-1006
2002	2006	Honda	CR-V ⁴	30-0025	30-1236
2007	2012	Honda	CR-V ⁴	30-0005	30-1436
1998	2004	Honda	Passport	30-0015	30-1075
2003	2008	Honda	Pilot	30-0005	30-1256
2007	2012	Hyundai	Santa Fe	30-0025	30-1396
1999-5	2004	Infiniti	QX4	30-0025	30-1115
2003	2005	Isuzu	Ascender	30-0025	30-1345
1998	2000	Isuzu	Hombre Pickup	30-0005	30-1065
1998	2004	Isuzu	Rodeo 4Dr	30-0015	30-1075
1999	2004	Jeep	Grand Cherokee/Laredo	30-0005	30-1135
2003	2004	Lexus	GX470 2.4 WD	30-0025	30-1325
1998	2000	Mazda	B-Series Pickup	30-0005	30-1055
2001	2012	Mazda	B-Series Pickup	30-0025	30-1165
2001	2007	Mazda	TrIBUTE ⁷	30-0025	30-1155
2001	2007	Mercury	Manner	30-0025	30-1155
1997	2001	Mercury	Mountaineer	30-0005	30-1055
2003	2008	Mitsubishi	Endeavor	30-0015	30-1355
1999-5	2004	Nissan	Pathfinder (Excl. Armada)	30-0025	30-1115
1998	2001	Oldsmobile	Bravada	30-0005	30-1065
2002	2004	Oldsmobile	Bravada	30-0025	30-1345
2006	2009	Pontiac	Torren ⁸	30-0025	30-1375
2002	2007	Subaru	Vue ⁹	30-0025	30-1375
1999	2005	Suzuki	Grand Vitara	30-0025	30-1305
1999	2003	Suzuki	XL7	30-0025	30-1305
2003	2009	Toyota	4Runner 2.4 WD	30-0025	30-1325
1998	2004	Toyota	Tacoma	30-0005	30-1105
1999	2003	Suzuki	XL7	30-0025	30-1305
2003	2009	Toyota	4Runner 2.4 WD	30-0025	30-1325
1998	2004	Toyota	Tacoma	30-0025	30-1105

FOOTNOTES: 4. Requires Minor Trimming Of Air Dam/Bumper Valance. 5. Requires Removal Of Tow Hooks If Equipped. 7. Will Interfere With Or Obstruct View Of License Plate. License Relocator Needed To Make Visible. 8. Requires Removal Of Skid Plate If Equipped.



NEW! - Tiger Shark 18000 109



NEW! - Tiger Shark 15000 110



NEW! - AC 1500 Winch 111



NEW! - Terra Series 112



SX Series 114



Talon & Tiger Shark 116-117



UT 3000 & LP Series 118



S Series & LT Series 119-120



NEW! - Auxiliary Battery Mount 121



Winch2Go 121



Winch Accessories & Parts 122

NEW! TIGER SHARK 18000/SR

FEATURES:

- 18,000 lbs. capacity
- 6.8 HP motor
- 3-Stage planetary gearing with 345:1 ratio
- Automatic cone brake
- 4-way stainless steel roller fairlead
- Aluminum hawse fairlead
- Heat insulated first layer
- Kick-N-Flip style freespool allows hand and foot operation
- 30' handheld remote control
- Optional wireless remote control - sold separately (part no. 2277)
- Heavy-duty, clevis pinned, latched hook
- Includes mounting hardware
- Textured Black Finish

MECHANICAL WARRANTY: Limited Lifetime
ELECTRONIC WARRANTY: Limited 3 Year



**30' HANDHELD
REMOTE INCLUDED**

PN# 1518001

SPECIFICATIONS

Winch Model:	Tiger Shark 18000 (wire rope) Tiger Shark 18000SR (synthetic rope)
Part Number:	1518000 (wire rope) 1518001 (synthetic rope)
Rated Line Pull:	18000lbs (8165kgs) single line
Motor:	Series wound 5.8hp/5.0kw, 12V DC
Gearbox:	3-Stage planetary
Gear Ratio:	345:1
Clutch:	Kick-N-Flip
Braking:	Automatic cone brake
Fairlead (wire rope):	4-way stainless steel roller fairlead
Fairlead (synthetic rope):	Aluminum hawse fairlead
Wire Rope:	29/64" x 85' (11.5mm x 26m)
Synthetic Rope:	33/64" x 79' (13mm x 24m)
Drum Size:	3.5" x 8.8" (88mm x 223mm)
Dimensions:	24.3" x 11.4" x 8.5" (618mm x 290mm x 216mm)
Mounting Bolt Pattern:	10" x 4.5" (254mm x 114mm) + 10" x 6.7" (254mm x 172mm)
Battery Single (Recommended Capacity):	680 CCA minimum (Dual 12V 600 CCA Recommended)
Net. Weight:	132lbs (60kgs) (wire rope) 97lbs (44kgs) (synthetic rope)
Packaging:	27.5" x 11.8" x 15.7" (700mm x 300mm x 400mm)
Remote Control:	30' wired handheld
Warranty:	Limited Lifetime Mechanical & 3 Year Limited Electrical
Finish:	Textured Black
Winch Hook:	Heavy-duty, clevis pinned latch hook

LINE SPEED & MOTOR CURRENT (FIRST LAYER)

Line Pull	Lbs	0	2000	6000	12000	18000
		Kgf	0	907	2710	5443
Line Speed	FPM	19.7	12.5	8.2	6.2	3.8
		MPM	6	3.8	2.5	1.9
Motor Current	Amps	70	120	200	290	440

LINE PULL & CABLE CAPACITY

Layer Of Cable	1	2	3	4	
Rated Line Pull Per Layer	Lbs	18000	15300	13580	10580
	Kgf	8165	6940	6160	4790
Cable Capacity Per Layer	Ft.	17.7	37	83	85
	M	5.4	11.4	19.4	26

DIMENSIONS

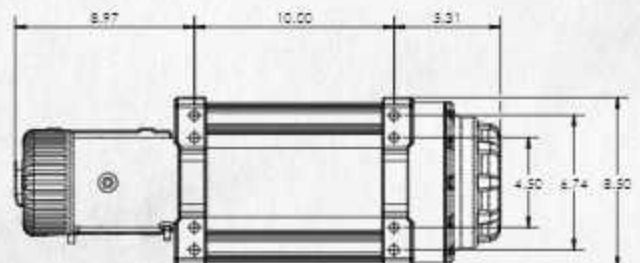
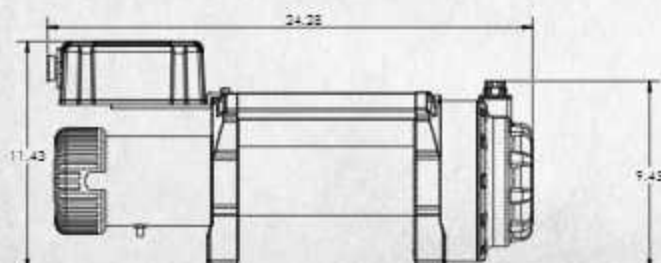

NEW! TIGER SHARK 15000/SR

FEATURES:

- 15,000 lbs. capacity
- 6.8 HP motor
- 3-Stage planetary gearing with 262:1 ratio
- Automatic cone brake
- 4-way stainless steel roller fairlead
- Aluminum hawse fairlead
- Heat insulated first layer
- Lever shift twist and turn freespool
- 30" handheld remote control
- Optional wireless remote control - sold separately (part no. 2277)
- Heavy-duty, clevis pinned, latched hook
- Includes mounting hardware
- Textured Black Finish

MECHANICAL WARRANTY: Limited Lifetime
ELECTRONIC WARRANTY: Limited 3 Year



**30" HANDHELD
REMOTE INCLUDED**

PN# 1515001

SPECIFICATIONS

Winch Model:	Tiger Shark 15000 (wire rope) Tiger Shark 15000SR (synthetic rope)
Part Number:	1515000 (wire rope) 1515001 (synthetic rope)
Rated Line Pull:	15000lbs (6804kgs) single line
Motor:	Series wound 6.8hp/5.0kw/12V DC
Gearbox:	3-Stage planetary
Gear Ratio:	262:1
Clutch:	Twist and Turn
Braking:	Automatic cone brake
Fairlead (wire rope):	4-way stainless steel roller fairlead
Fairlead (synthetic rope):	Aluminum hawse fairlead
Wire Rope:	7/16" x 62' (11.5mm x 25m)
Synthetic Rope:	15/32" x 78' (12mm x 24m)
Drum Size:	5" x 9.78" (76mm x 223mm)
Dimensions:	24.3" x 9.8" x 7.8" (610mm x 249mm x 198mm)
Mounting Bolt Pattern:	10" x 4.5" (254mm x 114.3mm)
Battery Single (Recommended Capacity):	650 CCA minimum (Dual 12V 600 CCA Recommended)
Net. Weight:	110lbs (50kgs) (wire rope) 77lbs (35kgs) (synthetic rope)
Packaging:	27.6" x 11.8" x 15.8" (701mm x 300mm x 401mm)
Remote Control:	30" wired handheld
Warranty:	Limited Lifetime Mechanical & 3 Year Limited Electrical
Finish:	Textured Black
Winch Hook:	Heavy-duty, clevis pinned latch hook

LINE SPEED & MOTOR CURRENT (FIRST LAYER)

Line Pull	Lbs						
	0	2000	6000	8000	12000	15000	
	Kgf						
	0	907	2722	3629	5443	6804	
Line Speed	FPM						
	19.7	10.2	6.6	7.9	5.9	3.9	
	MPM						
	6	3.1	2.6	2.4	1.8	1.2	
Motor Current	Amps	70	150	200	250	330	420

LINE PULL & CABLE CAPACITY

Layer Of Cable					
	1	2	3	4	
Rated Line Pull By Layer	Lbs	15000	12800	11000	9800
	Kgf	6804	5808	4290	4445
Cable Capacity By Layer	Fl.	15.1	35.1	59.7	82
	M	4.6	10.7	18.2	25

DIMENSIONS

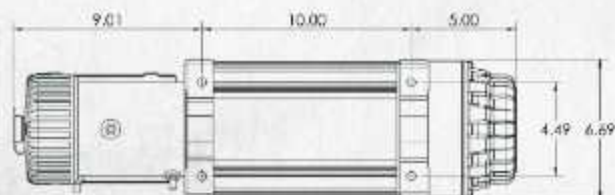
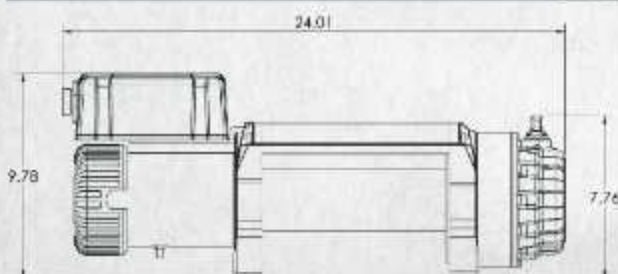

NEW! AC 1500 ELECTRIC WINCH

FEATURES:

- 1,500 lbs. capacity
- 1.1 HP, 120V AC motor
- 2-Stage planetary gearing with 262:1 ratio
- Standard Drum 3.2" L x 1.9" D
- 4-way roller fairlead
- .150" x 35' wir rope
- Heat insulated first layer
- Pull and turn clutch handle
- IP66 protection from water and dust
- 12" handheld remote
- Clevis pinned, latched hook
- 2-hole mounting bolt pattern 3.1" on center
- Gray powder coat finish
- Kit includes: remote control, wire rope, roller fairlead, mounting plate, fasteners and power cord

WARRANTY: Limited 2 Year



SPECIFICATIONS

Winch Model:	AC 1500
Part Number:	1715001
Rated Line Pull:	1,500lbs
Motor:	1.1 HP 120V AC
Gearbox:	2-Stage planetary
Gear Ratio:	262:1
Freeseool:	Pull and Turn
Brake:	Dynamic Braking
Fairlead:	4-Way Roller Fairlead
Wire Rope:	.150" x 35'
IP Rating:	IP 66 Water and Dust Resistant
Mounting Bolt Pattern:	2-Hole pattern 3.1" on center
Remote Control:	12" handheld remote control
Warranty:	2 Year Limited
Finish:	Gray Powder Coat
Winch Hook:	Clevis pinned/latched

LINE SPEED & MOTOR CURRENT (FIRST LAYER)

Line Pull	Lbs	0	375	750	1125	1500	15000
	Kgf	0	170	340	510	680	6804
Line Speed	FPM	10.5	8.3	6.4	5.2	4.2	3.9
	MPM	3.2	2.6	1.9	1.5	1.2	1.2
Motor Current	Amps	1.2	3.3	5.6	7.8	9.2	420

LINE PULL & CABLE CAPACITY

Layer Of Cable		1	2	3	4
Rated Line Pull By Layer	Lbs	1500	1310	1163	1045
	Kgf	680	594	5227	474
Cable Capacity By Layer	Ft.	10.7	25.0	36.9	35.0
	M	3.2	7.0	11.2	10.8

DIMENSIONS

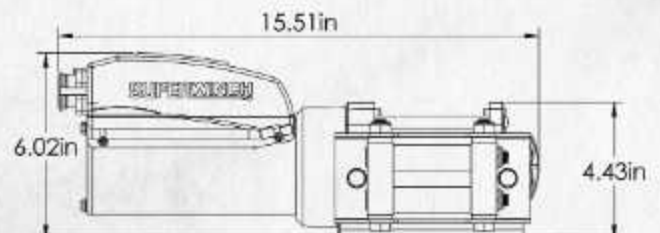
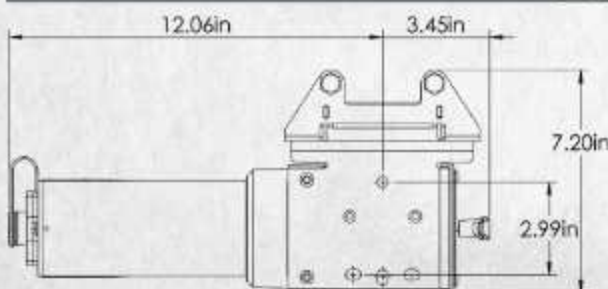

WESTIN[™] | SUPERWINCH



TERRA UTV/ATV RECOVERY WINCH

The new generation Terra Series winches from Superwinch are engineered specifically to meet the rugged demands of ATV and UTV enthusiasts. Available in 2500, 3500 and 4500 lbs. capacities with a choice of wire or synthetic rope, these powerful winches have been redesigned and improved inside and out. Each winch is loaded with a powerful motor, strong all steel gearing and a steel drum for superior performance and durability. The Terra Series winches have an IP67 rating for water and dust protection, so they are always ready for action.

NEW! TERRA 4500/SR

FEATURES:

- 4,500 lbs capacity
- 1.8 HP permanent magnetic motor
- Clockable motor
- 3-Stage planetary gearing with 198:1 ratio
- Heavy-duty steel drum
- All steel gear set
- Sealed solenoid with circuit breaker
- Easy to engage ergonomic freespool control knob
- IP67 protection from water and dust
- 15/64" - 50' wire rope
- 1/4" - 50' synthetic rope
- Heavy-duty, clevis pinned, latched hook
- 4-way roller fairlead (wire rope)
- Aluminum hawse fairlead (synthetic rope)
- 10' handheld remote with handlebar rocker switch
- Wide drum adds rope capacity
- Universal mounting plate
- Mounting bolt pattern 3" x 6.66"
- Gray wrinkle powder coat finish

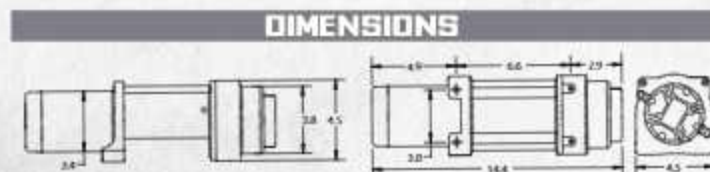

NEW! TERRA 3500/SR

FEATURES:

- 3,500 lbs capacity
- 1.6 HP permanent magnetic motor
- Clockable motor
- 3-Stage planetary gearing with 198:1 ratio
- Heavy-duty steel drum
- All steel gear set
- Sealed solenoid with circuit breaker
- Easy to engage ergonomic freespool control knob
- IP67 protection from water and dust
- 7/32" - 32' wire rope
- 7/32" - 32' synthetic rope
- Heavy-duty, clevis pinned, latched hook
- 4-way roller fairlead (wire rope)
- Aluminum hawse fairlead (synthetic rope)
- 10' handheld remote with handlebar rocker switch
- Narrow drum allows easier mounting in tight spaces
- Universal mounting plate
- Mounting bolt pattern 3" x 4.9"
- Gray wrinkle powder coat finish



10' HANDHELD REMOTE INCLUDED



PN# 1135280

PN# 1135270

DIMENSIONS

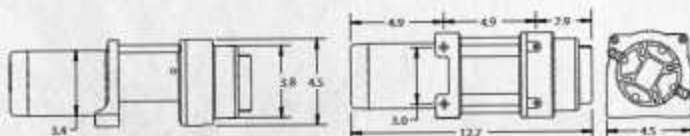

NEW! TERRA 2500/SR

FEATURES:

- 2,500 lbs capacity
- 1.5 HP permanent magnetic motor
- Clockable motor
- 3-Stage planetary gearing with 138:1 ratio
- Heavy-duty steel drum
- All steel gear set
- Sealed solenoid with circuit breaker
- Easy to engage ergonomic freespool control knob
- IP67 protection from water and dust
- 3/16" - 40' wire rope
- 3/16" - 40' synthetic rope
- Heavy-duty, clevis pinned, latched hook
- 4-way roller fairlead (wire rope)
- Aluminum hawse fairlead (synthetic rope)
- 10' handheld remote with handlebar rocker switch
- Narrow drum allows easier mounting in tight spaces
- Universal mounting plate
- Mounting bolt pattern 3" x 4.9"
- Gray wrinkle powder coat finish



10' HANDHELD REMOTE INCLUDED



PN# 1125280

PN# 1125270

DIMENSIONS

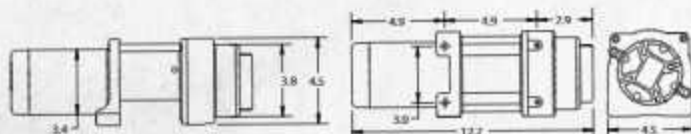

SX SERIES WINCH

INTRODUCING THE SX SERIES BY SUPERWINCH

Hit the trail with confidence with the SX Series Winch from Superwinch! The SX Series is a tough, capable winch built on the proven performance of the vaunted Superwinch Tiger Shark Series. We thoroughly modernized the Tiger Shark's solid architecture to provide the Power, Speed, and Innovation demanded by today's discerning enthusiasts. The SX Series is IP68-rated for dustproof and waterproof operation, giving you the confidence to explore in any condition or terrain, while the patented Drum Light and Rechargeable Winch Remote Flashlight make it easy to use the SX Series day or night. The durable metallic graphite powder coat finish provides both great looks and long life, and the innovative Pull-And-Turn engagement handle provides hassle-free operation, no matter the load or conditions. Available in 10,000 and 12,000 lbs versions, when you run the Superwinch SX Series, you run the best!



FEATURES AND BENEFITS:

• ERGONOMIC PULL-AND-TURN CLUTCH HANDLE

Allows hassle-free operation free spool

• PATENTED DRUM LIGHT

Provides superior visibility in low light conditions

• MULTI-FUNCTION WIRED REMOTE

Includes integrated rechargeable flashlight

• WIRELESS REMOTE

[SYNTHETIC ROPE MODELS ONLY]

Ergonomic handle with molle loop clip

• RELOCATABLE DIE-CAST CONTROL BOX

Heavy-duty aluminum construction with 18" leads

• CLOCKABLE 3-STAGE PLANETARY GEARBOX

Can be oriented in 4 different positions



WIRELESS*
REMOTE

*Included with synthetic
rope models only



DIMENSIONS

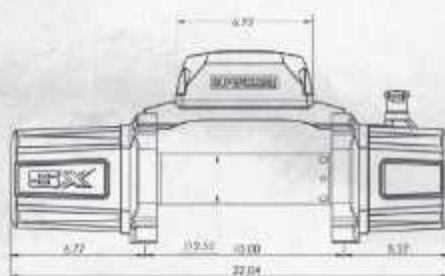

SX 10 / PART NO. 1710200

WIRE ROPE



FEATURES:

- Rated line pull of 10,000 lbs
- 5.5 HP sealed motor
- Relocatable die-cast aluminum control box
- Includes 12" handheld wired remote
- Pull-and turn clutch handle
- 3-stage planetary gearing with 218:1 ratio
- Patented drumlight

WIRED REMOTE

- Wire rope measures 3/8" x 85'
- Heavy duty clevis winch hook
- Stainless Steel 4-Way Roller Fairlead
- 100% full load holding automatic mechanical brake
- IP68-rated waterproof and dustproof winch
- Durable metallic graphite powder coat finish

MECHANICAL WARRANTY: Limited Lifetime
ELECTRICAL WARRANTY: Limited 7-Year

SX 10SR / PART NO. 1710201

SYNTHETIC ROPE



FEATURES:

- Rated line pull of 10,000 lbs
- 5.5 HP sealed motor
- Relocatable die-cast aluminum control box
- Includes wireless handheld remote & 12" handheld wired remote
- Pull-and turn clutch handle
- 3-stage planetary gearing with 218:1 ratio

WIRED REMOTE

- Patented drumlight
- Synthetic rope measures 3/8" x 80'
- Heavy duty clevis winch hook
- Aluminum hoarse fairlead
- 100% full load holding automatic mechanical brake
- IP68-rated waterproof and dustproof winch
- Durable metallic graphite powder coat finish

WIRELESS REMOTE

Includes with synthetic models only

MECHANICAL WARRANTY: Limited Lifetime
ELECTRICAL WARRANTY: Limited 7-Year

SX 12 / PART NO. 1712200

WIRE ROPE



FEATURES:

- Rated line pull of 12,000 lbs
- 6.0 HP sealed motor
- Relocatable die-cast aluminum control box
- Includes 12" handheld wired remote
- Pull-and turn clutch handle
- 3-stage planetary gearing with 231:1 ratio
- Patented drumlight

WIRED REMOTE

- Wire rope measures 3/8" x 85'
- Heavy duty clevis winch hook
- Stainless Steel 4-Way Roller Fairlead
- 100% full load holding automatic mechanical brake
- IP68-rated waterproof and dustproof winch
- Durable metallic graphite powder coat finish

MECHANICAL WARRANTY: Limited Lifetime
ELECTRICAL WARRANTY: Limited 7-Year

SX 12SR / PART NO. 1712201

SYNTHETIC ROPE



FEATURES:

- Rated line pull of 12,000 lbs
- 6.0 HP sealed motor
- Relocatable die-cast aluminum control box
- Includes wireless handheld remote & 12" handheld wired remote
- Pull-and turn clutch handle
- 3-stage planetary gearing with 231:1 ratio

WIRED REMOTE

- Patented drumlight
- Synthetic rope measures 3/8" x 80'
- Heavy duty clevis winch hook
- Aluminum hoarse fairlead
- 100% full load holding automatic mechanical brake
- IP68-rated waterproof and dustproof winch
- Durable metallic graphite powder coat finish

WIRELESS REMOTE

Includes with synthetic models only

MECHANICAL WARRANTY: Limited Lifetime
ELECTRICAL WARRANTY: Limited 7-Year

WESTIN

SUPERWINCH

TALON 9.5i / PART NO. 1695210 INTEGRATED WITH WIRE ROPE



FEATURES:

- Rated line pull of 9,500 lbs
- Integrated 5.2 HP sealed motor
- Automatic load holding external disc brake design located outside drum
- Ergonomic free spool knob lifts and turns effortlessly
- 2-stage spur/2-stage planetary gearing with 148:1 ratio
- Sealed submersible vented solenoid
- Wire rope measures 3/8" x 85'
- Heavy duty, clevis pinned, latched hook
- 15" ergo handheld remote control with coiled cable and LED light indicators
- 62 FPM no load line speed
- IP 67 rated against dust and moisture
- Stainless steel 4-way roller fairlead
- Can be mounted foot down or foot forward providing multiple mounting options

MECHANICAL WARRANTY: Limited Lifetime

ELECTRICAL WARRANTY: Limited 7-Year

SPECIFICATIONS	
Solenoid	V54 (Sealed Submersible Vented)
Brake	Mechanical, Automatic, Outside Drum
Cable Diameter* (MM)	3/8" (9.5)
Weight Installed LBS (KG)	92 (42)

PERFORMANCE		
No Load	Amps	90
	Line Speed FPM (MPM)	19 (5.7)
At Load	Amps	410
	Line Speed FPM (MPM)	2 (0.6)

TALON 9.5i SR / PART NO. 1695211 INTEGRATED WITH SYNTHETIC ROPE



FEATURES:

- Rated line pull of 9,500 lbs
- Integrated 5.2 HP sealed motor
- Automatic 100% load holding disc brake is located outside the drum
- Brake minimizes heat transfer to retain synthetic rope integrity
- Ergonomic free spool knob lifts and turns effortlessly
- 2-stage spur/2-stage planetary gearing with 148:1 ratio
- Sealed submersible vented solenoid
- Certified Dyneema synthetic rope measures 3/8" x 85'
- Heavy duty, clevis pinned, latched hook
- 15" ergo handheld remote control with coiled cable and LED light indicators
- 62 FPM no load line speed
- IP 67 rated against dust and moisture
- Blue anodized aluminum hawse fairlead

MECHANICAL WARRANTY: Limited Lifetime

ELECTRICAL WARRANTY: Limited 7-Year

SPECIFICATIONS	
Solenoid	V54 (Sealed Submersible Vented)
Brake	Mechanical, Automatic, Outside Drum
Cable Diameter* (MM)	3/8" (9.5)
Weight Installed LBS (KG)	87 (39)

PERFORMANCE		
No Load	Amps	78
	Line Speed FPM (MPM)	62 (18.9)
At Load	Amps	430
	Line Speed FPM (MPM)	5.0 (1.5)

TALON 9.5 / PART NO. 1695200 WIRE ROPE



FEATURES:

- Rated line pull of 9,500 lbs
- 5.2 HP sealed motor
- Automatic load holding external disc brake design located outside the drum
- Ergonomic free spool knob lifts and turns effortlessly
- 2-stage spur/2-stage planetary gearing with 148:1 ratio
- Sealed submersible vented solenoid
- Wire rope measures 3/8" x 85'
- Heavy duty, clevis pinned, latched hook
- 15" ergo handheld remote control with coiled cable and LED light indicators
- 62 FPM no load line speed
- IP 67 rated against dust and moisture
- Stainless steel 4-way roller fairlead

MECHANICAL WARRANTY: Limited Lifetime

ELECTRICAL WARRANTY: Limited 7-Year

SPECIFICATIONS	
Solenoid	V54 (Sealed Submersible Vented)
Brake	Mechanical, Automatic, Outside Drum
Cable Diameter* (MM)	3/8" (9.5)
Weight Installed LBS (KG)	90 (41)

PERFORMANCE		
No Load	Amps	75
	Line Speed FPM (MPM)	62 (18.9)
At Load	Amps	430
	Line Speed FPM (MPM)	5.0 (1.5)

TALON 9.5SR / PART NO. 1695201 SYNTHETIC ROPE



FEATURES:

- Rated line pull of 9,500 lbs
- 5.2 HP sealed motor
- Automatic 100% load holding disc brake is located outside the drum
- Brake minimizes heat transfer to retain synthetic rope integrity
- Ergonomic free spool knob lifts and turns effortlessly
- 2-stage spur/2-stage planetary gearing with 148:1 ratio
- Sealed submersible vented solenoid
- Certified Dyneema synthetic rope measures 3/8" x 80'
- Heavy duty, clevis pinned, latched hook
- 15" ergo handheld remote control with coiled cable and LED light indicators
- 62 FPM no load line speed
- IP 67 rated against dust and moisture
- Blue anodized aluminum hawse fairlead

MECHANICAL WARRANTY: Limited Lifetime

ELECTRICAL WARRANTY: Limited 7-Year

SPECIFICATIONS	
Solenoid	V54 (Sealed Submersible Vented)
Brake	Mechanical, Automatic, Outside Drum
Cable Diameter* (MM)	3/8" (9.5)
Weight Installed LBS (KG)	90 (41)

PERFORMANCE		
No Load	Amps	75
	Line Speed FPM (MPM)	62 (18.9)
At Load	Amps	430
	Line Speed FPM (MPM)	5.0 (1.5)

SUPERWINCH

WESTIN

TIGER SHARK 9500 / PART NO. 1595200

WIRE ROPE



FEATURES:

- Rated line pull of 9,500 lbs
- 5.2 HP motor
- 3-Stage planetary gearing with 218:1 ratio
- Weather sealed solenoid
- Ergonomic pull and turn freespool
- Wire rope measures 21.64" x 9.5"
- Heavy-duty, clevis pinned, latched hook
- Stainless steel 4-way roller fairlead
- Rugged handheld remote control
- Stainless steel tiebars

MECHANICAL WARRANTY: Limited Lifetime

ELECTRICAL WARRANTY: Limited 7-Year

SPECIFICATIONS	
Solenoid	Weather Sealed
Brake	Mechanical, Automatic, Load Holding
Cable Diameter" (MM)	21.64" (8.5)
Weight Installed LBS (KG)	80 (41)

PERFORMANCE		
No Load	Amps	80
	Line Speed	19 (5.7)
	FPM (MPM)	
At Load	Amps	340
	Line Speed	4 (1.2)
	FPM (MPM)	

TIGER SHARK 9500SR / PART NO. 1595201

SYNTHETIC ROPE



FEATURES:

- Rated line pull of 9,500 lbs
- 5.2 HP motor
- 3-Stage planetary gearing with 218:1 ratio
- Weather sealed solenoid
- Ergonomic pull and turn freespool
- Synthetic rope measures 3.0" x 8.0"
- Automatic load holding brake design
- Heavy-duty, clevis pinned, latched hook
- Aluminum hawse fairlead
- Rugged handheld remote control
- Stainless steel tiebars

MECHANICAL WARRANTY: Limited Lifetime

ELECTRICAL WARRANTY: Limited 7-Year

SPECIFICATIONS	
Solenoid	Weather Sealed
Brake	Mechanical, Automatic, Load Holding
Cable Diameter" (MM)	3.0" (8.5)
Weight Installed LBS (KG)	69 (26.7)

PERFORMANCE		
No Load	Amps	80
	Line Speed	19 (5.7)
	FPM (MPM)	
At Load	Amps	340
	Line Speed	4 (1.2)
	FPM (MPM)	

TIGER SHARK 11500 / PART NO. 1511200

WIRE ROPE



FEATURES:

- Rated line pull of 11,500 lbs
- 5.8 HP motor
- 3-Stage planetary gearing with 218:1 ratio
- Weather sealed solenoid
- Ergonomic pull and turn freespool
- Wire rope measures 3.0" x 8.4"
- Heavy-duty, clevis pinned, latched hook
- Stainless steel 4-way roller fairlead
- Rugged handheld remote control

MECHANICAL WARRANTY: Limited Lifetime

ELECTRICAL WARRANTY: Limited 7-Year

SPECIFICATIONS	
Solenoid	Weather Sealed
Brake	Mechanical, Automatic, Load Holding
Cable Diameter" (MM)	3.0" (8.5)
Weight Installed LBS (KG)	94 (42)

PERFORMANCE		
No Load	Amps	80
	Line Speed	19 (5.7)
	FPM (MPM)	
At Load	Amps	410
	Line Speed	2 (0.6)
	FPM (MPM)	

TIGER SHARK 11500SR / PART NO. 1511201

SYNTHETIC ROPE



FEATURES:

- Rated line pull of 11,500 lbs
- 5.8 HP motor
- 3-Stage planetary gearing with 218:1 ratio
- Weather sealed solenoid to reduce damage from the elements
- Ergonomic pull and turn freespool
- Synthetic rope measures 3.0" x 8.0"
- Automatic load holding brake design
- Heavy-duty, clevis pinned, latched hook
- Aluminum hawse fairlead
- Rugged handheld remote control

MECHANICAL WARRANTY: Limited Lifetime

ELECTRICAL WARRANTY: Limited 7-Year

SPECIFICATIONS	
Solenoid	Weather Sealed
Brake	Mechanical, Automatic, Load Holding
Cable Diameter" (MM)	3.0" (8.5)
Weight Installed LBS (KG)	94 (42)

PERFORMANCE		
No Load	Amps	80
	Line Speed	19 (5.7)
	FPM (MPM)	
At Load	Amps	410
	Line Speed	2 (0.6)
	FPM (MPM)	

TIGER SHARK 13500 / PART NO. 1513200

WIRE ROPE



FEATURES:

- Rated line pull of 13,500 lbs
- 5.3 HP motor
- 4-Stage planetary gearing with 518:1 ratio
- Weather sealed solenoid
- Ergonomic pull and turn freespool
- Wire rope measures 13/32" x 95'
- Heavy-duty, clevis pinned, latched hook
- Stainless steel 4-way roller fairlead
- Rugged handheld remote control

MECHANICAL WARRANTY: Limited Lifetime
ELECTRICAL WARRANTY: Limited 7-Year

SPECIFICATIONS	
Solenoid	Weather Sealed
Brake	Mechanical, Automatic, Load Holding
Cable Diameter* (MM)	13.32* (10.3)
Weight Installed LBS (KG)	154 (69.7)

PERFORMANCE		
No Load	Amps	120
	Line Speed FPM (MPM)	11 (3.4)
At Load	Amps	440
	Line Speed FPM (MPM)	4 (1.2)

UT 3000 / PART NO. 1331200

WIRE ROPE



FEATURES:

- Rated line pull of 3,000 lbs
- 1.2 HP permanent magnet motor provides dynamic braking
- 1-Stage planetary gearing with 153:1 ratio
- Circuit breaker protected
- Free-spooling, pull and turn clutch
- Wire rope measures 3/16" x 40'
- Clevis pinned hook
- Zinc plated 4-way fairlead
- 12' wired hand-held remote

MECHANICAL WARRANTY: Limited Lifetime
ELECTRICAL WARRANTY: Limited 7-Year

SPECIFICATIONS	
Solenoid	Circuit Breaker Protected
Brake	Dynamic
Cable Diameter* (MM)	5.18* (7.9)
Weight Installed LBS (KG)	19.5 (8.84)

PERFORMANCE		
No Load	Amps	5
	Line Speed FPM (MPM)	8.5 (2.53)
At Load	Amps	110
	Line Speed FPM (MPM)	2.2 (0.6)

LP 8500 / PART NO. 1585202

WIRE ROPE



FEATURES:

- Rated line pull of 8,500 lbs
- 4.5 HP sealed motor
- 3-Stage planetary gearing with 235:1 ratio
- Sealed solenoid
- Twist and turn freespool clutch lever
- Wire rope measures 5/16" x 95'
- Heavy-duty, clevis pinned, latched hook
- Stainless steel hawse fairlead
- 12' rubber handheld remote control

MECHANICAL WARRANTY: Limited 1-Year
ELECTRICAL WARRANTY: Limited 1-Year

SPECIFICATIONS	
Solenoid	Sealed With Circuit Breaker
Brake	Automatic/Load Holding
Cable Diameter* (MM)	5.18* (7.9)
Weight Installed LBS (KG)	73 (33.11)

PERFORMANCE		
No Load	Amps	84
	Line Speed FPM (MPM)	18 (5.5)
At Load	Amps	320
	Line Speed FPM (MPM)	3.5 (1.1)

LP 10000 / PART NO. 1510200

WIRE ROPE



FEATURES:

- Rated line pull of 10,000 lbs
- 5.1 HP sealed motor
- 3-Stage planetary gearing with 235:1 ratio
- Sealed solenoid
- Twist and turn freespool clutch lever
- Wire rope measures 3/8" x 85'
- Heavy-duty, clevis pinned, latched hook
- Zinc plated 4-way roller fairlead
- 12' rubber handheld remote control

MECHANICAL WARRANTY: Limited 1-Year
ELECTRICAL WARRANTY: Limited 1-Year

SPECIFICATIONS	
Solenoid	Sealed With Circuit Breaker
Brake	Automatic/Load Holding
Cable Diameter* (MM)	3.0* (9.5)
Weight Installed LBS (KG)	85 (37.64)

PERFORMANCE		
No Load	Amps	90
	Line Speed FPM (MPM)	16 (4.87)
At Load	Amps	350
	Line Speed FPM (MPM)	1.52 (0.46)

S 5500 / PART NO. 1455200

WIRE ROPE



FEATURES:

- Rated line pull of 5,500 lbs
- 3.6 HP permanent magnet motor provides dynamic braking
- 3-Stage planetary gearing with 159:1 ratio
- Sealed solenoid
- Lever style freespool allows hand or foot operation
- Steel cut gears for better engagement and longevity
- Wire rope measures 1/4" x 40'
- Automatic load holding brake
- Stainless steel 2-way roller fairlead

MECHANICAL WARRANTY: Limited 2-Year
ELECTRICAL WARRANTY: Limited 2-Year

SPECIFICATIONS	
Solenoid	V54 (Sealed Submersible Vented)
Brake	Mechanical, Automatic, Outside Drum
Cable Diameter* (MM)	3/8" (9.5)
Weight Installed LBS (KG)	90 (41)

PERFORMANCE			
No Load	Amps	75	
	Line Speed FPM (MPM)	62 (16.9)	
At Load	Amps	430	
	Line Speed FPM (MPM)	5.0 (1.5)	

S 5500SR / PART NO. 1455201

SYNTHETIC ROPE



FEATURES:

- Rated line pull of 5,500 lbs
- 3.6 HP permanent magnet motor provides dynamic braking
- 3-Stage planetary gearing with 159:1 ratio
- Sealed solenoid
- Lever style freespool allows hand or foot operation
- Steel cut gears for better engagement and longevity
- Synthetic rope measures 1/4" x 40'
- Automatic load holding brake
- Stainless steel 2-way roller fairlead

MECHANICAL WARRANTY: Limited 2-Year
ELECTRICAL WARRANTY: Limited 2-Year

SPECIFICATIONS	
Solenoid	V54 (Sealed Submersible Vented)
Brake	Mechanical, Automatic, Outside Drum
Cable Diameter* (MM)	3/8" (9.5)
Weight Installed LBS (KG)	92 (42)

PERFORMANCE			
No Load	Amps	80	
	Line Speed FPM (MPM)	19 (5.7)	
At Load	Amps	410	
	Line Speed FPM (MPM)	2 (0.6)	

S 7500 / PART NO. 1475200

WIRE ROPE



FEATURES:

- Rated line pull of 7,500 lbs
- 3.6 HP permanent magnet motor provides dynamic braking
- 3-Stage planetary gearing with 249:1 ratio
- Sealed solenoid
- Lever style freespool allows hand or foot operation
- Steel cut gears for better engagement and longevity
- Wire rope measures 3/16" x 54'
- Automatic load holding brake
- Stainless steel 2-way roller fairlead

MECHANICAL WARRANTY: Limited 2-Year
ELECTRICAL WARRANTY: Limited 2-Year

SPECIFICATIONS	
Solenoid	V54 (Sealed Submersible Vented)
Brake	Mechanical, Automatic, Outside Drum
Cable Diameter* (MM)	3/8" (9.5)
Weight Installed LBS (KG)	90 (41)

PERFORMANCE			
No Load	Amps	75	
	Line Speed FPM (MPM)	62 (16.9)	
At Load	Amps	430	
	Line Speed FPM (MPM)	6.0 (1.5)	

S 7500SR / PART NO. 1475201

SYNTHETIC ROPE



FEATURES:

- Rated line pull of 7,500 lbs
- 3.6 HP permanent magnet motor provides dynamic braking
- 3-Stage planetary gearing with 249:1 ratio
- Sealed solenoid
- Lever style freespool allows hand or foot operation
- Steel cut gears for better engagement and longevity
- Synthetic rope measures 5/16" x 54'
- Automatic load holding brake
- Stainless steel 2-way fairlead

MECHANICAL WARRANTY: Limited 2-Year
ELECTRICAL WARRANTY: Limited 2-Year

SPECIFICATIONS	
Solenoid	V54 (Sealed Submersible Vented)
Brake	Mechanical, Automatic, Outside Drum
Cable Diameter* (MM)	3/8" (9.5)
Weight Installed LBS (KG)	92 (42)

PERFORMANCE			
No Load	Amps	80	
	Line Speed FPM (MPM)	19 (5.7)	
At Load	Amps	410	
	Line Speed FPM (MPM)	2 (0.6)	

LT 2000 / PART NO. 1120210

WIRE ROPE



FEATURES:

- Rated line pull of 2,000 lbs
- Sealed 1.0 HP permanent magnet motor
- 1-Stage planetary gearing with 133:1 ratio
- Circuit breaker protected
- Free-spooling, pull and turn clutch
- Wire rope measures 5/32" x 50'
- Permanent/latched hook
- Zinc plated 4-way roller fairlead
- Handle bar mounted rocker switch

MECHANICAL WARRANTY: Limited 1-Year
ELECTRICAL WARRANTY: Limited 1-Year

SPECIFICATIONS	
Solenoid	Sealed, Circuit Breaker Protected
Brake	Automatic, 100% Load Holding
Cable Diameter* (MM)	5/32" (3.9)
Weight Installed LBS (KG)	14.2 (6.44)

PERFORMANCE		
No Load	Amps	10
	Line Speed FPM (MPM)	10 (3.0)
At Load	Amps	100
	Line Speed FPM (MPM)	2.5 (0.8)

LT 3000 / PART NO. 1130220

WIRE ROPE



FEATURES:

- Rated line pull of 3,000 lbs
- Sealed 1.2 HP permanent magnet motor
- 3-Stage planetary gearing with 136:1 ratio
- Sealed solenoid, circuit breaker protected
- Free-spooling, ergonomic control clutch
- Wire rope measures 3/16" x 50'
- Heavy-duty, clevis pinned, latched hook
- Zinc plated 4-way roller fairlead
- 12" hand-held remote with handlebar mounted rocker switch

MECHANICAL WARRANTY: Limited 1-Year
ELECTRICAL WARRANTY: Limited 1-Year

SPECIFICATIONS	
Solenoid	Sealed, Circuit Breaker Protected
Brake	Automatic, 100% Load Holding
Cable Diameter* (MM)	3/16" (4.8)
Weight Installed LBS (KG)	20 (9.0)

PERFORMANCE		
No Load	Amps	15
	Line Speed FPM (MPM)	23 (7.0)
At Load	Amps	100
	Line Speed FPM (MPM)	4.0 (1.2)

LT 4000 / PART NO. 1140220

WIRE ROPE



FEATURES:

- Rated line pull of 4,000 lbs
- Sealed 1.4 HP permanent magnet motor
- 3-Stage planetary gearing with 166:1 ratio
- Sealed solenoid, circuit breaker protected
- Free-spooling, ergonomic control clutch
- Wire rope measures 3/16" x 50'
- Heavy-duty, clevis pinned, latched hook
- Zinc plated 4-way roller fairlead
- 12" hand-held remote with handlebar mounted rocker switch

MECHANICAL WARRANTY: Limited 1-Year
ELECTRICAL WARRANTY: Limited 1-Year

SPECIFICATIONS	
Solenoid	Sealed, Circuit Breaker Protected
Brake	Automatic, 100% Load Holding
Cable Diameter* (MM)	3/16" (4.8)
Weight Installed LBS (KG)	26

PERFORMANCE		
No Load	Amps	20
	Line Speed FPM (MPM)	16 (5.4)
At Load	Amps	300
	Line Speed FPM (MPM)	4.5 (1.3)

LT 4000SR / PART NO. 1140230

SYNTHETIC ROPE



FEATURES:

- Rated line pull of 4,000 lbs
- Sealed 1.4 HP permanent magnet motor
- 3-Stage planetary gearing with 166:1 ratio
- Sealed solenoid, circuit breaker protected
- Free-spooling, ergonomic control clutch
- Synthetic rope measures 3/16" x 50'
- Heavy-duty, clevis pinned, latched hook
- Aluminum house fairlead
- 12" hand-held remote with handlebar mounted rocker switch

MECHANICAL WARRANTY: Limited 1-Year
ELECTRICAL WARRANTY: Limited 1-Year

SPECIFICATIONS	
Solenoid	Sealed, Circuit Breaker Protected
Brake	Automatic, 100% Load Holding
Cable Diameter* (MM)	3/16" (4.8)
Weight Installed LBS (KG)	26

PERFORMANCE		
No Load	Amps	20
	Line Speed FPM (MPM)	16 (5.4)
At Load	Amps	300
	Line Speed FPM (MPM)	4.5 (1.3)

WINCH2GO

WIRE ROPE

PART NO. 1140222



FEATURES:

- Rated line pull of 4,000 lbs
- 1.4 HP permanent magnet motor
- Cam action knob freespool clutch
- Wire rope measures 7/32" x 40'
- Sealed handheld wired remote
- Steel base plate with integrated hause
- 1/4" clevis pinned, latched hook
- 12" handheld remote control
- (2) heavy duty 8" straps rated at 4,000 lbs
- (3) 4,000 lbs D-shackles
- 8,000 lbs snatch block
- 10' quick connect battery cables
- Pair of heavy duty winch gloves
- Weighs 43 lbs

MECHANICAL WARRANTY: Limited 2-Year

ELECTRICAL WARRANTY: Limited 2-Year

SPECIFICATIONS	
Solenoid	Sealed, Circuit Breaker Protected
Brake	Mechanical, Automatic, Load Holding
Cable Diameter" (MM)	7/32"
Weight Installed LBS (KG)	43 (19.5)

PERFORMANCE		
No Load	Amps	20
	Line Speed FPM (MPM)	20 (76.0)
At Load	Amps	220
	Line Speed FPM (MPM)	5.5 (1.6)

WINCH2GO SR

SYNTHETIC ROPE

PART NO. 1140232



FEATURES:

- Rated line pull of 4,000 lbs
- 1.4 HP permanent magnet motor
- Cam action knob freespool clutch
- Synthetic rope measures 7/32" x 40'
- Sealed handheld wired remote
- Steel base plate with integrated hause
- 1/4" clevis pinned, latched hook
- 12" handheld remote control
- (2) heavy duty 8" straps rated at 4,000 lbs
- (3) 4,000 lbs D-shackles
- 8,000 lbs snatch block
- 10' quick connect battery cables
- Pair of heavy duty winch gloves
- Weighs 41 lbs

MECHANICAL WARRANTY: Limited 2-Year

ELECTRICAL WARRANTY: Limited 2-Year

SPECIFICATIONS	
Solenoid	Sealed, Circuit Breaker Protected
Brake	Mechanical, Automatic, Load Holding
Cable Diameter" (MM)	7/32"
Weight Installed LBS (KG)	43 (19.5)

PERFORMANCE		
No Load	Amps	20
	Line Speed FPM (MPM)	20 (76.0)
At Load	Amps	220
	Line Speed FPM (MPM)	5.5 (1.6)

NEW! AUXILIARY BATTERY MOUNT



FEATURES:

- Designed exclusively for Jeep JL / JT (excl. diesel and 4XE)
- Allows installation of auxiliary Group 34/35 AGM (gel) batteries
- Battery is positioned between the frame rails for a lower center of gravity
- Heavy-duty integrated skid plate for added protection from off-road obstacles
- Kit includes all necessary hardware and wiring
- Adding an auxiliary battery provides increased performance for the operation of accessories, winches, coolers, compressors, etc.
- E-coated base coat provides long lasting corrosion protection
- Durable textured black powder coat finish

FINISH: Textured Black Powder Coat

MATERIAL: E-Coated Steel

WARRANTY: 3-Year

START	END	MAKE	MODEL	TEXTURED BLACK
2018	2022	Jeep	Wrangler JL (Excl. Diesel)	2592
2020	2022	Jeep	Gladator (Excl. Diesel)	2592

FOOTNOTES: Only compatible with Group 34/35, AGM, and lithium batteries that can be mounted sideways.

WINCH ACCESSORIES

GENUINE SUPERWINCH QUALITY PARTS



BOW SHACKLE

(2) 1/2" with 5/8" diameter pin,
4,400 lb capacity
Part No. 230226S



BOW SHACKLE

(2) 3/4" with 7/8" diameter pin,
10,000 lb. capacity
Part No. 2538



PULLEY BLOCK WITH HOOK

Pulley Block rated to 12,000 lbs.
Part No. 2229A



PULLEY BLOCK WITH HOOK

Pulley Block rated to 8,000 lbs.
Part No. 2227A



SNATCH BLOCK

Snatch Block
rated to 20,000 lbs.
Part No. 7750A



SNATCH BLOCK

Snatch Block
rated to 12,000 lbs.
Part No. 90-20508



SNATCH BLOCK

Snatch Block
rated to 36,000 lbs.
Part No. 7755



SOFT SHACKLE

1/2" Soft Shackle,
44,000 lbs. breaking strength
Part No. 2574



SUPERWINCH RECOVERY ROPE

1" diameter x 30' long with reinforced
closed-loop ends rated at 30,000 lbs.
Part No. 2592



RECOVERY KIT - HEAVY DUTY

Includes: (1) 36,000 lb Snatch Block,
(2) 3/4" Bow Shackles rated at 10,000 lbs,
(1) 4"x8" Tree Trunk Protector rated at 30,000 lbs,
(1) 3"x30" Recovery Strap rated at 26,000 lbs,
(1) 10 ft of 5/16" grade-1 Choker Chain,
(1) Pair Winching Gloves, Heavy-Duty Nylon Gear Bag
Part No. 2575



RECOVERY KIT - GETAWAY

Includes: (2) 3/4" Bow Shackles rated at 10,000 lbs,
(1) 2"x8" Tree Trunk Protector rated at 20,000 lbs,
(1) 3"x30" Recovery Strap rated at 26,000 lbs,
(1) Pair Winching Gloves, Nylon Gear Bag
Part No. 2578



RECOVERY KIT - LIGHT DUTY

Includes: (1) 8,800 lb Snatch Block,
(1) 1/2" Bow Shackle rated at 4,400 lbs,
(2) 1"x8" Tree Trunk Protector rated at 10,000 lbs,
(1) Pair Winching Gloves,
Nylon Gear Bag
Part No. 2577



RECOVERY KIT - MEDIUM DUTY

Includes: (1) 20,000 lb Snatch Block,
(2) 3/4" Bow Shackles rated at 10,000 lbs,
(1) 2"x30" Recovery Strap rated at 20,000 lbs,
(1) 2"x8" Tree Trunk Protector rated at 20,000 lbs,
(1) Winch Hook Snubber,
(1) Pair Winching Gloves,
Heavy-Duty Nylon Gear Bag
Part No. 2576

WINCH ACCESSORIES CONTINUED

GENUINE SUPERWINCH QUALITY PARTS



CRADLE HITCH MOUNT

For use with 5X 10/105R, Talon 9.55R, Tiger Shark 95005R, LP 8500/10000, Terra 45, and UT3000 Winches. Includes: Mounting Hardware, Fairlead Adapter Plate, and Hitch Pin. Works With Any 2" Class III/IV Receiver Hitch.
Part No. 2050



RECEIVER SHACKLE BRACKET

Fits 2" Class III/IV Hitch Receiver. Rated at 10,000 lbs; includes 3/4" bow shackle with 7/8" pin.
Part No. 2573



QUICK CONNECT FRONT WIRING KIT

5' Leadwire, electrical connectors and cable ties. Fits 5,000-18,000 lb Winches. Fits 2 - 4 Gauge Wire.
Part No. 2007



QUICK CONNECT

Electrical Connectors for winches up to 18,000 lbs. Fits 2 - 4 Gauge Wire.
Part No. 2236



HAND SAVER CLEVIS FLAG

Clevis Flag w/Logo
1 inch x 12 inch
Part No. S103138-01



RECOVERY STRAP

3' wide x 30' long with reinforced closed-loop ends rated at 25,000 lbs.
Part No. 2587



RECOVERY STRAP

2' wide x 30' long with reinforced closed-loop ends rated at 20,000 lbs.
Part No. 2518



TREE TRUNK PROTECTOR

1" wide x 8' long.
Rated to 10,000 lbs.
Part No. 2302284



TREE TRUNK PROTECTOR

2" wide x 8' long.
Rated to 20,000 lbs.
Part No. 2588



TREE TRUNK PROTECTOR

4" wide x 8' long.
Rated to 30,000 lbs.
Part No. 2589



WINCH COVER

Neoprene Material with Superwinch Logo. Use with LP Series; Tiger Shark 9500/11500; 55500/7500 Winches.
Part No. 1570



WINCH COVER

Neoprene Material with Superwinch Logo. Use with LT Series; Terra Series; UT Series Winches.
Part No. 2302297



WINCH COVER

Neoprene Material with Superwinch Logo. Use with 5x 10/12; Talon 9.5 Integrated Winches.
Part No. 1571



WINCH COVER

Neoprene Material with Superwinch Logo. Use with Talon 9.5 (non-integrated) Talon 12.5; Tiger Shark 13500/15500/17500 Winches.
Part No. 1572



WINCHING GLOVES

(1) Pair, Size XL
Part No. 2580

REPLACEMENT PARTS









GENUINE SUPERWINCH QUALITY PARTS



PART NUMBER	PRODUCT NAME	CIRCUIT BREAKER	ROLLER FAIRLEAD	HAWSE FAIRLEAD	CLUTCH HANDLE	MOTOR
1585202	LP8500 WINCH	2124800		90-12865		
1510200	LP10000 WINCH	2124800	2302293			
1120210	LT2000 WINCH	2124800	87-12911			
1130220	LT3000 WINCH	2124800	87-12911			87-12890
1140220	LT4000 WINCH	2124800	87-12911			87-24078
1140230	LT4000SR WINCH	2124800		87-24077		87-24078
1455200	S5500 WINCH	2124800	89-42678		89-30154	
1455201	S5500SR WINCH	2124800	89-42678		89-30154	
1475200	S7500 WINCH	2124800	89-42678		89-30154	
1475201	S7500SR WINCH	2124800	89-42678		89-30154	
S104089	SH1000 HOIST		S105858			
S104091	SH1000ND HOIST		S105850			
S105800	SH1000 HOIST		S105858			
S104093	SH1000ND HOIST		S105850			
1710200	SX10				90-41440	90-41452
1710201	SX10SR			90-41446		
1712200	SX12				90-41440	90-41455
1712201	SX12SR			90-41446		
1695200	TALON 9.5 WINCH		90-32473		90-24547	90-41409
1695210	TALON 9.5I WINCH		90-32473		90-24547	90-41409
1695211	TALON 9.5ISR WINCH			90-24507	90-24547	90-41409
1695201	TALON 9.5SR WINCH			90-24507	90-24547	90-41409
1612200	TALON 12.5 WINCH		90-32473		90-24547	90-41411
1612201	TALON 12.5SR WINCH			90-24507	90-24547	90-41411
1618200	TALON 18 WINCH		90-32473		90-24569	90-41411
1618201	TALON 18SR WINCH			90-24507	90-24569	90-41411
1125220	TERRA 25 WINCH	87-14541	87-41340-01			87-42601
1125230	TERRA 25SR WINCH	87-14541		87-42619		
1135220	TERRA 35 WINCH	87-14541	87-41340-01			87-42602
1135230	TERRA 35SR WINCH	87-14541		87-42619		87-42602
1145220	TERRA 45 WINCH	87-14541	87-41340			87-42603
1145230	TERRA 45SR WINCH	87-14541		87-42620		87-42603
1595200	TIGER SHARK 9500 WINCH	2124800	90-32493		90-24571	90-32513
1595201	TIGER SHARK 9500SR WINCH	2124800		90-24572	90-24571	90-32513
1511200	TIGER SHARK 11500 WINCH	2124800	90-32493		90-24571	90-32514
1511201	TIGER SHARK 11500SR WINCH	2124800		90-24572	90-24571	90-32514
1513200	TIGER SHARK 13500 WINCH		90-32505		90-24579	
1517200	TIGER SHARK 17500 WINCH		90-32505		90-24579	
1331200	UT3000 WINCH	2124800				
1140232	WINCH2GO SR					87-24078
1140222	WINCH2GO STEEL ROPE					87-24078

REPLACEMENT PARTS CONTINUED

GENUINE SUPERWINCH QUALITY PARTS

							
MOTOR COVER	RELAY	REMOTE CONTROL KIT	WIRE ROPE	SYNTHETIC ROPE	SOCKET ASSEMBLY	CONTACTOR/SOLENOID	SWITCH
		2274	90-12879		90-24573	90-12877	
		2274	90-12879		90-24573	90-12877	
			87-42611				2320200
		87-12895	87-42611		87-14151	87-12893	87-12894
		87-12895	87-42611		87-14151	87-12893	87-12894
		87-12895		87-42613	87-14151	87-12893	87-12894
89-42880		2271 OR 2272	89-24640		90-14140	98-10880	
89-42880		2271 OR 2272		89-24642	90-14140	98-10880	
89-42880		2271 OR 2272	89-24640		90-14140	98-10880	
89-42880		2271 OR 2272		89-24642	90-14140	98-10880	
		S105649					
		S105649					
		S105649					
		S105649					
					90-41437		
					90-41437		
	90-24552	2273	90-24575		90-24551	90-32459	
	90-24552	2273	90-24575		90-24551	90-32459	
	90-24552	2273		90-24506	90-24551	90-32459	
	90-24552	2273		90-24506	90-24551	90-32459	
	90-24552	2273	90-24575		90-24551	90-32459	
	90-24552	2273		90-24506	90-24551	90-32459	
	90-24552	2273	90-24563		90-24551	90-32459	
	90-24552	2273		90-24564	90-24551	90-32459	
		2275	87-42611		87-42618	87-42608	87-42609
		2275		87-42613	87-42618	87-42608	87-42609
		2275	87-42611		87-42618	87-42608	87-42609
		2275		87-42613	87-42618	87-42608	87-42609
		2275	87-42612		87-42618	87-42608	87-42609
		2275		87-42614	87-42618	87-42608	87-42609
		2274	90-24575		90-24573	90-32492	
		2274		90-24595	90-24573	90-32492	
		2274	90-24576		90-24573	90-32492	
		2274		90-24595	90-24573	90-32492	
		2275	90-24585		90-24581	90-32503	
		2275	90-24583		90-24581	90-32503	
		2274	87-42611		90-24573		
				87-42613		87-12893	
			87-42611			87-12893	



» **NEW!** Mesa Roof Rack & Side Ladder 127



» Overland Cargo Rack 128



» HLR Truck Rack 129



» HD Headache Rack 130



» HD Ladder Rack 131



» HDX Def Tank Skid Plate 131



» Truck-Pal Tailgate Ladder 131



» Truck Bed Mats and Tailgate Mats 132



» Platinum Oval Bed Rails 133



» Front and Tailgate Caps 133

» Bed Caps 134

NEW! MESA ROOF RACK

TEXTURED BLACK

- » Extruded aluminum construction offers unparalleled strength and durability
- » Accommodates most roof top tents providing an outdoor seamless camping experience
- » 16-gauge wind deflector panel enhances aerodynamics by redirecting airflow, reducing drag, and easily removable to install auxiliary lighting
- » Ability to remove hardtop panels while roof rack is installed
- » Adjustable crossbars 2.5" x 1.5" allows you to customize the setup according to the size and shape of your cargo
- » Electrostatic base coat provides long lasting corrosion protection
- » Bolt-on installation - no drilling required

FINISH: Textured Black Powder Coat
 MATERIAL: Aluminum Rack & Steel Brackets
 WARRANTY: 3-Year

MESA ROOF RACK WEIGHT CAPACITY

	STATIC	DYNAMIC
15-00025	600	400
15-00045	450	300
15-00015	450	200

(WEIGHT HAS TO BE EVENLY DISTRIBUTED)

START	END	MAKE	MODEL
2021	2023	Ford	Bronco 4Dr (Excl. Bronco Sport)
2019	2023	Mercedes-Benz	Sprinter (w/ 144" Wheelbase)*
2010	2023	Toyota	4Runner
2016	2023	Toyota	Tacoma Double Cab

FOOTNOTES: 214. Fits Vehicles With OEM Roof Rails.



INCLUDES RUBBER TRIM ON FRONT VISOR, MOUNTING BRACKETS AND ALL NECESSARY HARDWARE FOR INSTALLATION

P/N 15-00045



SHOWN WITH AXIS SQUARE LED AUXILIARY LIGHTS
 P/N 09-12218A-PR (SPOT) P/N 09-12219B-PR (FLOOD)

P/N 15-00025



SHOWN WITH B-FORCE 40" SINGLE ROW LIGHT BAR
 P/N 09-12211-40C

START	END	MAKE	MODEL	TEXTURED BLACK
2021	2023	Ford	Bronco 4Dr (Excl. Bronco Sport)	15-00015
2019	2023	Mercedes-Benz	Sprinter (w/ 144" Wheelbase)*	15-00025
2010	2023	Toyota	4Runner	15-00005
2016	2023	Toyota	Tacoma Double Cab	15-00045

NEW! MESA SIDE LADDER

TEXTURED BLACK

- » 2-piece 11-gauge aluminum construction designed to enhance strength and accessibility of your vehicle's roof while maintaining lightweight
- » 14.5" x 2.5" x 1" wide steps provide ample space for comfortable and secure footing during ascent and descent
- » Dimple top plate steps offers superior grip in any weather condition
- » Pre-drilled side mounting holes accommodates for endless customization and cargo accessories
- » Electrostatic base coat provides long lasting corrosion protection

FINISH: Textured Black Powder Coat
 MATERIAL: Aluminum Rack & Steel Brackets
 WARRANTY: 3-Year

START	END	MAKE	MODEL
2019	2023	Mercedes-Benz	Sprinter High Roof

FOOTNOTES: 1. Requires Drilling.



HARDWARE AND 7-GAUGE MOUNTING BRACKETS INCLUDED



START	END	MAKE	MODEL	TEXTURED BLACK
2019	2023	Mercedes-Benz	Sprinter High Roof	15-00025

WESTIN[™] | TRUCK BED ACCESSORIES

OVERLAND CARGO RACK

TEXTURED BLACK

- › Low profile design keeps cargo gear below cab roofline
- › Constructed of strong 14-gauge steel
- › Multi-mounts rails for most roof-top tents
- › Rack lengths available in 45" or 57"
- › Top support rails can be mounted in multiple positions
- › Hardware and mounting brackets included
- › E-coated base coat provides long lasting corrosion protection
- › Textured black powder coat finish
- › Bolt-on installation - no drilling required*
- *Optional OEM Trail Rail System

FINISH: Textured Black Powder Coat

MATERIAL: E-Coated Steel

WARRANTY: 3-Year

WEIGHT CAPACITY RATINGS:

- › Off-road Dynamic (Moving) 250 lbs
- › Off-road Dynamic (Moving) 400 lbs
- › Static (Non-Moving) 800 lbs



START	END	MAKE	MODEL	TEXTURED BLACK
2020	2022	Jeep	Gladiator ^{1,2}	51-10099
2006	2022	Toyota	Tacoma (5' Bed) ^{1,2}	51-10016
2006	2022	Toyota	Tacoma (6' Bed) ^{1,2}	51-10025

FOOTNOTES: 1. Not Compatible With Tonneau Cover If Equipped. 2. Requires Use Of OEM Bed Rail Kit. 3. Requires Use Of OEM Trail Rail System.

HLR TRUCK RACK BLACK POWDER COAT

- » Extruded aluminum frame
- » Aluminum punch plate screen
- » Protects rear window without blocking view
- » Strong, sturdy and lightweight design
- » Includes channels to bolt on various accessories
- » Brackets made of mild steel and custom designed for each application
- » Easy installation using existing factory holes
- » No drilling required for most applications

FINISH: Black Powder Coat
MATERIAL: Aluminum
WARRANTY: 5-Year



START	END	MAKE	MODEL	TEXTURED BLACK
2007	2016	Chevrolet	Silverado 1500 (6.5' Bed)(Excl. Classic)	57-81006
2016	2023	Chevrolet	Silverado 1500 (6.5' Bed)	57-81095
2007	2016	Chevrolet	Silverado 1500 (6.5' Bed)(Excl. Classic)	57-81006
2019	2023	Chevrolet	Silverado 1500 (6.5' Bed)(Excl. 2019 LD)	57-81094
2007	2016	Chevrolet	Silverado 1500 (8' Bed)(Excl. Classic)	57-81003
2019	2023	Chevrolet	Silverado 1500 (8' Bed)	57-81093
2007	2019	Chevrolet	Silverado 2500/3500 (6.5' Bed)(Excl. Classic)	57-81005
2007	2019	Chevrolet	Silverado 2500/3500 (8' Bed)(Excl. Classic)	57-81005
2020	2023	Chevrolet	Silverado 2500/3500	57-81135
2019	2019	Chevrolet	Silverado LD (6.5' Bed)	57-81005
2009	2018	Dodge	Ram 1500 (6.5' Bed)(Excl. RamBox)	57-81025
2009	2018	Dodge	Ram 1500 (6.5' Bed)(Excl. RamBox)	57-81023
2009	2018	Dodge	Ram 1500 (8' Bed)(Excl. RamBox)	57-81025
2010	2018	Dodge	Ram 2500/3500 (6.5' Bed)(Excl. RamBox)	57-81023
2010	2018	Dodge	Ram 2500/3500 (8' Bed)(Excl. RamBox)	57-81023
2010	2018	Dodge	Ram 2500/3500 (8' Bed)(Excl. RamBox)	57-81023
2016	2023	Ford	F-150 (6.5' Bed)(Excl. Lightning EV)	57-81038
2016	2023	Ford	F-150 (6.5' Bed)(Excl. Lightning EV)	57-81035
2016	2023	Ford	F-150 (8' Bed)(Excl. Lightning EV)	57-81038
1999	2016	Ford	F-250/350/450/550 Super Duty (6.75' Bed)	57-81045
2017	2023	Ford	F-250/350/450/550 Super Duty (6.75' Bed)	57-81058
1999	2016	Ford	F-250/350/450/550 Super Duty (8' Bed)	57-81045
2017	2023	Ford	F-250/350/450/550 Super Duty (8' Bed)	57-81058
2007	2018	GMC	Sierra 1500 (6.5' Bed)(Excl. Classic)	57-81005
2019	2023	GMC	Sierra 1500 (6.5' Bed)	57-81095
2007	2018	GMC	Sierra 1500 (6.5' Bed)(Excl. Classic)	57-81005
2019	2023	GMC	Sierra 1500 (6.5' Bed)(Excl. 2019 Limited)	57-81095
2007	2018	GMC	Sierra 1500 (8' Bed)(Excl. Classic)	57-81005
2019	2023	GMC	Sierra 1500 (8' Bed)	57-81095
2019	2019	GMC	Sierra 1500 Limited (6.5' Bed)	57-81005
2007	2019	GMC	Sierra 2500/3500 (6.5' Bed)(Excl. Classic)	57-81005
2007	2019	GMC	Sierra 2500/3500 (8' Bed)(Excl. Classic)	57-81005
2020	2023	GMC	Sierra 2500/3500	57-81135
2019	2023	Ram	1500 (6.5' Bed)(Excl. Classic)(Excl. RamBox)	57-81025
2009	2018	Ram	1500 (6.5' Bed)(Excl. RamBox)	57-81025
2009	2018	Ram	1500 (6.5' Bed)(Excl. RamBox)	57-81025
2019	2023	Ram	1500 (6.5' Bed)(Excl. Classic)(Excl. RamBox)	57-81025
2009	2018	Ram	1500 (8' Bed)(Excl. Classic)(Excl. RamBox)	57-81025
2009	2018	Ram	1500 (8' Bed)(Excl. RamBox)	57-81025
2019	2023	Ram	1500 Classic (6.5' Bed)(Excl. RamBox)	57-81025
2019	2023	Ram	1500 Classic (6.5' Bed)(Excl. RamBox)	57-81025
2019	2023	Ram	1500 Classic (8' Bed)(Excl. RamBox)	57-81025
2010	2018	Ram	2500/3500 (6.5' Bed)(Excl. RamBox)	57-81025
2010	2018	Ram	2500/3500 (8' Bed)(Excl. RamBox)	57-81025
2010	2018	Ram	2500/3500 (8' Bed)(Excl. RamBox)	57-81025
2006	2023	Toyota	Tacoma (5' Bed)	57-81069
2006	2023	Toyota	Tacoma (5' Bed)	57-81065
2007	2021	Toyota	Tundra (5.5' Bed)	57-81075
2007	2021	Toyota	Tundra (6.5' Bed)	57-81075
2007	2021	Toyota	Tundra (8' Bed)	57-81075

ACCESSORIES

DESCRIPTION	BLACK
Adjustable Tie Down - Multi-Point	57-89015
Adjustable Tie Down - Single Point	57-89005
Beacon Light Mount - Large	57-89065
Beacon Light Mount - Small	57-89055
Ladder - Side Load Bracket	57-89028
LED Auxiliary Light Mount	57-89045
LED Light Bar Brackets	57-89035
Mini Light Bar Mounts	57-89075

FOOTNOTES: 1. May Interfere With Camera Located On Third Brake Light If Equipped.

HD HEADACHE RACK

BLACK POWDER COAT / WHITE POWDER COAT

- » Angled louvers provide shade and protect rear window
- » 2" diameter round top tube
- » Welded tie-down hooks
- » 4 mounting tabs for lights
- » Drilling required

FINISH: Black Powder Coat
 MATERIAL: E-Coated Steel
 WARRANTY: 3 Year

FINISH: White Powder Coat
 MATERIAL: E-Coated Steel
 WARRANTY: 3-Year



START	END	MAKE	MODEL	OVERALL HEIGHT	WT CAP STD BRACKET (LBS)	TOOLBOX BRACKET (LBS)	BLACK	WHITE
1988	2000	Chevrolet	C/K 1500/2500/3500HD ^{1,4,5}	26"	750	200	57-8025	57-8023
2007	2019	Chevrolet	Silverado 1500/2500/3500 (Excl. 2019 Silverado 1500) ^{1,4,5}	26"	750	200	57-8025	57-8023
1999	2007	Chevrolet	Silverado Classic 1500/2500/3500HD ^{1,4,5}	26"	750	200	57-8025	57-8023
2019	2019	Chevrolet	Silverado LD ^{1,4,5}	26"	750	200	57-8025	57-8023
2002	2018	Dodge	Ram 1500 (Excl. RamBox) ^{2,4,5}	27 1/2"	750	200	57-8035	57-8033
2005	2023	Dodge	Ram 2500/3500 (Excl. RamBox) ^{2,4,5}	27 1/2"	750	200	57-8035	57-8033
2004	2023	Ford	F-150 (Excl. Lightning EV) ^{1,4,5}	26"	750	200	57-8025	57-8023
2008	2024	Ford	F-250/350 Super Duty ^{1,4,5}	29"	750	200	57-8095	57-8093
2008	2023	Ford	F-450/550HD Super Duty ^{1,4,5}	29"	750	200	57-8095	57-8093
1988	2000	GMC	C/K 1500/2500/3500HD ^{1,4,5}	26"	750	200	57-8025	57-8023
2019	2019	GMC	Sierra 1500 Limited ^{1,4,5}	26"	750	200	57-8025	57-8023
2007	2019	GMC	Sierra 1500/2500/3500 (Excl. 2019 Sierra 1500) ^{1,4,5}	26"	750	200	57-8025	57-8023
1999	2007	GMC	Sierra Classic 1500/2500/3500HD ^{1,4,5}	26"	750	200	57-8025	57-8023
2002	2018	Ram	1500 (Excl. RamBox) ^{1,4,5}	27 1/2"	750	200	57-8035	57-8033
2019	2023	Ram	1500 Classic (Excl. RamBox) ^{1,4,5}	27 1/2"	750	200	57-8035	57-8033
2008	2023	Ram	2500/3500 (Excl. RamBox) ^{1,4,5}	27 1/2"	750	200	57-8035	57-8033
2007	2021	Toyota	Tundra ^{1,4,5}	26"	750	200	57-8025	57-8023

FOOTNOTES: Requires Lower Isolator To Be Replaced With Washer/Nut Combination Or Modification To Lower Isolator To Fit If Rubber Mounted Lights Are Used.

1. Compatible With Toolboxes Up To 70 Inches Wide. 2. Compatible With Toolboxes Up To 71 Inches Wide. 3. Compatible With Toolboxes Up To 72 Inches Wide. 4. Use Mount Kit Part # 57-8093 (White) Or Part # 57-8095 (Black) To Accommodate Larger Tool Boxes. 5. Requires Drilling Truck Bed.



HD LADDER RACK

BLACK POWDER COAT

- » Heavy duty 1 3/4" round top tube
- » Use 1 in conjunction with headache rack
- » Mount 2 for use without headache rack
- » Includes 30" adjustable Velcro support strap*
- » Drilling required

FINISH: Black Powder Coat
 MATERIAL: E-Coated Steel
 WARRANTY: 3 Year



*Velcro is provided for support only. It is not to be used as a sole means for securing cargo items.

	SINGLE PACK BLACK	SET OF 2 BLACK	WT CAPACITY (LBS)
UNIVERSAL HD Ladder Rack	87-9005	87-9015	250

HDX DEF TANK SKID PLATE

TEXTURED BLACK

- » Replaces factory DEF tank shield and plastic cover with stronger material than factory shield
- » Durable 8 gauge steel main body extends the life of your DEF tank by protecting it from potential damage caused by road debris
- » Lighter 12 gauge front cover provides a finished look and easy access to DEF tank
- » Aluminum HDX badge riveted onto the front cover
- » Mounts to frame and factory L-brackets that hold the DEF tank
- » Bolt on installation - no drilling required
- » Mounting hardware included

FINISH: Textured Black
 MATERIAL: E-Coated Steel
 WARRANTY: 3-Year



START	END	MAKE	MODEL	BLACK
2017	2019	Chevrolet	Silverado 25/3500 Diesel	87-11005
2017	2019	GMC	Sierra 25/3500 Diesel	87-11005

TRUCK-PAL TAILGATE LADDER

BRUSHED ALUMINUM

- » Lightweight aluminum construction
- » Duty rated at 300 lbs
- » Mountable on trucks with bed covers
- » Fits open tailgates up to 38" high
- » Registered U.S. Patent

FINISH: Brushed
 MATERIAL: 6063-T8 Aluminum Alloy
 WARRANTY: 3-Year



HEIGHT	PART NO.
38"	10-3000

FOOTNOTES: Will work with properly installed tonneau covers, camper shells and tie-downs.

TRUCK BED MATS / TAILGATE MATS

BLACK RUBBER

- » Heat molded and cut for specific truck bed size and design applications
- » 3/8" thick bed mat
- » For use with or without a spray liner
- » Made of 100% recycled rubber
- » Made in the USA



FINISH: Black
MATERIAL: Rubber
WARRANTY: 3-Year



CUSTOM FIT TRUCK BED MAT

START	END	MAKE	MODEL	BED LENGTH	MAT DIMS	BED MAT
2015	2022	Chevrolet	Colorado	5'	53" x 60"	50-6389
2015	2022	Chevrolet	Colorado	6'	53" x 72"	50-6390
2007	2018	Chevrolet	Silverado 1500	5.5'	62" x 69"	50-6165
2007	2018	Chevrolet	Silverado 1500	6.5'	62" x 75"	50-6166
2007	2018	Chevrolet	Silverado 1500	8'	62" x 97"	50-6169
2019	2023	Chevrolet	Silverado 1500	5.75'		50-6468
2019	2023	Chevrolet	Silverado 1500 (Excl. 2019 LD)	6.5'		50-6475
2007	2007	Chevrolet	Silverado 1500/2500/3500 Classic	6.5'	64" x 78"	50-6175
2007	2019	Chevrolet	Silverado 2500/3500HD (Excl. Classic)	6.5'	62" x 75"	50-6145
2007	2019	Chevrolet	Silverado 2500/3500HD (Excl. Classic)	8'	62" x 97"	50-6168
2019	2019	Chevrolet	Silverado LD	5.5'	62" x 69"	50-6165
1999	2006	Chevrolet	Silverado 500 (Excl. 1999-2000 C/K)	6.5'	64" x 78"	50-6176
2002	2018	Dodge	Ram 1500	6.5'	64" x 74"	50-6195
2008	2018	Dodge	Ram 1500	8'	64" x 97"	50-6209
2009	2018	Dodge	Ram 1500	5.5'	63" x 66"	50-6205
2002	2018	Dodge	Ram 2500/3500	6.5'	64" x 74"	50-6196
2015	2023	Ford	F-150 (Excl. Lightning Ev)	6.5'	64" x 66"	50-6350
2016	2023	Ford	F-150 (Excl. Lightning Ev)	6.5'	64" x 78"	50-6368
2015	2023	Ford	F-150 (Excl. Lightning Ev)	8'	64" x 96"	50-6378
2004	2014	Ford	F-150 (Excl. Heritage)	6.5'	63" x 66"	50-6105
2004	2014	Ford	F-150 (Excl. Heritage)	6.5'	62" x 73"	50-6115
2017	2023	Ford	F-250/350	6.75'	64" x 96"	50-6406
2017	2023	Ford	F-250/350	8'	64" x 96"	50-6410
1999	2016	Ford	F-250/350 Super Duty	6.75'	64" x 82"	50-6125
1999	2016	Ford	F-250/350 Super Duty	8'	64" x 96"	50-6133
2022	2023	Ford	Mustang			50-6488
2019	2023	Ford	Ranger	5'		50-6456
2015	2022	GMC	Canyon	6'	53" x 72"	50-6396
2015	2022	GMC	Canyon	8'	53" x 90"	50-6395
1999	2006	GMC	Sierra (Excl. 1999-2000 C/K)	6.5'	64" x 78"	50-6178
2007	2018	GMC	Sierra 1500	5.5'	62" x 69"	50-6165
2007	2018	GMC	Sierra 1500	6.5'	62" x 75"	50-6166
2007	2018	GMC	Sierra 1500	8'	62" x 97"	50-6168
2019	2023	GMC	Sierra 1500	5.75'		50-6465
2019	2023	GMC	Sierra 1500 (Excl. 2019 Limited)	6.5'		50-6473
2019	2019	GMC	Sierra 1500 Limited	6.5'	62" x 75"	50-6146
2007	2007	GMC	Sierra 1500/2500/3500 Classic	6.5'	64" x 78"	50-6175
2007	2019	GMC	Sierra 2500/3500HD	8'	62" x 97"	50-6168
2007	2019	GMC	Sierra 2500/3500HD (Excl. Classic)	6.5'	62" x 75"	50-6145
2002	2018	Ram	1500	6.5'	64" x 74"	50-6195
2008	2018	Ram	1500	8'	64" x 97"	50-6209
2009	2018	Ram	1500	5.5'	63" x 66"	50-6205
2019	2023	Ram	1500 (Excl. Classic)	5.7'		50-6425
2019	2023	Ram	1500 (Excl. Classic)	6.5'		50-6438
2019	2023	Ram	1500 Classic	5.5'	63" x 66"	50-6206
2019	2023	Ram	1500 Classic	6.5'	64" x 74"	50-6199
2019	2023	Ram	1500 Classic	8'	64" x 97"	50-6208
2002	2018	Ram	2500/3500	6.5'	64" x 74"	50-6196
2006	2023	Toyota	Tacoma	5'	62" x 69"	50-6316
2006	2023	Toyota	Tacoma	6'	62" x 72"	50-6219
1999	2006	Toyota	Tundra	6.5'	63" x 76"	50-6244
2007	2021	Toyota	Tundra	5.5'	66" x 67"	50-6236
2007	2021	Toyota	Tundra	6.5'	66" x 79"	50-6225

TAILGATE MAT

START	END	MAKE	MODEL	BED DIMS	TAILGATE MAT
1988	2007	Chevrolet/GMC	Silverado/Sierra Classic (Excl. 1988-1991 Crew Cab)	60" x 19"	50-6519
2007	2016	Chevrolet/GMC	Silverado/Sierra	59" x 18"	50-6525
2004	2014	Ford	F-150	55" x 20"	50-6536
2019	2023	Ram	1500 (Excl. Classic)		50-6666
2006	2016	Toyota	Tacoma	51" x 18"	50-6539
2007	2016	Toyota	Tundra	59" x 26"	50-6546
All	All	All	Universal Mid-Size, 54in X 15in	54" x 15"	50-6555

PLATINUM OVAL BED RAILS

POLISHED

- » Universal lengths
- » Heavy duty 304 stainless steel
- » Easy to install
- » Flexible mounting system accommodates most stake pockets with no drilling required

- » Drill mount hardware included for universal fit
- » Accentuates and enhances truck appeal

FINISH: Polished
MATERIAL: 304 Stainless
WARRANTY: Lifetime



START	END	MAKE	MODEL	POLISHED
2007	2013	Chevrolet	Silverado Sierra (5.5' Bed)	50-2030
1990	2013	Chevrolet	Silverado Sierra (5.5' Bed)	50-2040
1999	2013	Chevrolet	Silverado Sierra (8' Bed)	50-2070
2009	2016	Dodge	Ram 1500 (5.5' Bed) (Excl. Ram Box)	50-2030
1994	2003	Dodge	Ram 1500/2500/3500 (6.5' Bed) (Excl. Ram Box)	50-2040
1994	2003	Dodge	Ram 1500/2500/3500 (8' Bed) (Old Body Style) (Excl. Ram Box)	50-2070
2004	2003	Ford	F-150 (5.5' Bed) (Excl. 2004 Heritage & Lightning EV)	50-2030
2015	2003	Ford	F-150 (5.5' Bed) (Excl. Lightning EV)	50-2030
2015	2003	Ford	F-150 (6.5' Bed) (Excl. Lightning EV)	50-2040
2004	2014	Ford	F-150 (6.75' Bed) (Excl. Heritage)	50-2050
2004	2003	Ford	F-150 (8' Bed) (Excl. Heritage & Lightning EV)	50-2070
2015	2003	Ford	F-150 (8' Bed) (Excl. Lightning EV)	50-2070
1999	2003	Ford	F-250/350/450/550HD Super Duty (6.5' Bed)	50-2050
1999	2003	Ford	F-250/350/450/550HD Super Duty (8' Bed)	50-2070
1999	2011	Ford	Ranger (5' Bed)	50-2040
2007	2013	GMC	Silverado Sierra (5.5' Bed)	50-2030
1999	2013	GMC	Silverado Sierra (5.5' Bed)	50-2040
1999	2013	GMC	Silverado Sierra (8' Bed)	50-2070
1994	2003	Ram	2500/3500 (6' Bed) (Excl. Ram Box)	50-2040
2009	2016	Ram	1500 (5.5' Bed) (Excl. Ram Box)	50-2030
1994	2016	Ram	1500 (6' Bed) (Excl. Ram Box)	50-2040
2019	2020	Ram	1500 Classic (5.5' Bed) (Excl. Ram Box)	50-2030
2019	2020	Ram	1500 Classic (6' Bed) (Excl. Ram Box)	50-2040
1994	2003	Ram	1500/2500/3500 (8' Bed) (Old Body Style) (Excl. Ram Box)	50-2070
2007	2021	Toyota	Tundra Crew Max (5.8' Bed)	50-2020
2007	2021	Toyota	Tundra Double Cab (6.5' Bed)	50-2040
2007	2021	Toyota	Tundra Double Cab (8' Bed)	50-2070

UNIVERSAL FIT CHART

OVERALL LENGTH	MOUNT HOLE (CENTER TO CENTER)	PART NO.
40"	36"	50-2000
51.5"	47.5"	50-2010
59"	54"	50-2020
54"	60"	50-2030
71.5"	67.5"	50-2040
79.5"	71.5"	50-2050
91.5"	87.5"	50-2070

FRONT AND TAILGATE CAPS

BLACK HIGH-IMPACT ABS

- » Protects tailgate rail against damage
- » Gives vehicle a finished factory look
- » Matching bedcaps available
- » Attaches with automotive grade tape

FINISH: Black
MATERIAL: High-Impact ABS
WARRANTY: Limited Lifetime



START	END	MAKE	MODEL	FRONT CAP	TAILGATE CAP
2004	2012	Chevrolet	Colorado	72-11167	72-11167
2004	2012	Chevrolet	Colorado	72-11167	72-11177
1998	1998	Chevrolet	C/K 1500/2500/3500 (Excl. Stepside Bed)	72-11191	72-11191
1994	2006	Chevrolet	S-10	72-11171	72-11171
2007	2013	Chevrolet	Silverado 1500 (Excl. 2007 Classic)	72-11168	72-11168
2007	2007	Chevrolet	Silverado 1500 Classic	72-11161	72-11161
1999	2006	Chevrolet	Silverado 1500 Sportside	—	72-11164
1999	2006	Chevrolet	Silverado 1500/2500LD (Excl. Sportside)	72-11161	72-11161
2001	2006	Chevrolet	Silverado 2500/3500HD	72-11161	72-11161
2007	2014	Chevrolet	Silverado 2500/3500HD (Excl. 2007 Classic)	72-11168	72-11168
1997	2004	Dodge	Dakota	72-11491	72-11491
2005	2007	Dodge	Dakota	72-11461	72-11461
2005	2011	Dodge	Dakota	72-11461	72-11437
1994	2001	Dodge	Ram 1500	72-11481	72-11481
2002	2008	Dodge	Ram 1500	—	72-11471
2002	2008	Dodge	Ram 1500/2500/3500	72-11471	—
2006	2008	Dodge	Ram 1500/2500/3500	—	72-11477
1994	2002	Dodge	Ram 2500/3500	72-11481	72-11481
1987	1996	Ford	F-150/250/350	—	72-11681

CONTINUED

FRONT AND TAILGATE CAPS CONTINUED

BLACK HIGH-IMPACT ABS

START	END	MAKE	MODEL	FRONT CAP	TAILGATE CAP
1993	2008	Ford	Ranger	72-11691	72-01691
2004	2012	GMC	Canyon	72-11167	72-01167
2005	2012	GMC	Canyon	72-11167	72-01177
1993	1993	GMC	C/K 1500/2500/3500 (Excl. 1983-1991 Crew Cab)	72-11191	72-01191
1999	2006	GMC	Sierra 1500 Sportside	—	72-01164
1999	2006	GMC	Sierra 1500/3500LD	72-11161	72-01161
2001	2006	GMC	Sierra 2500/3500HD	72-11161	72-01161
2007	2014	GMC	Sierra 2500/3500	72-11168	72-01168
1994	1997	Mazda	Pickup	72-11691	72-01691
1993	2000	Nissan	Frontier	—	72-01071
2010	2021	Nissan	Frontier	—	72-01891
1989	1995	Toyota	Pickup	—	72-01701
1996	2004	Toyota	Tacoma	—	72-01791
2000	2005	Toyota	Tundra	—	72-01771

FOOTNOTES: 1. Replacement Part.

BED CAPS

BLACK HIGH-IMPACT ABS

- » Protects bed railing against damage
- » Gives vehicle a finished factory look
- » Attaches with automotive grade tape
- » Available with or without stake pocket holes in ribbed or smooth finish

FINISH: Black

MATERIAL: High-Impact ABS

WARRANTY: Limited Lifetime



START	END	MAKE	MODEL	W/ STAKE HOLES		W/O STAKE HOLES	
				SMOOTH	RIBBED	SMOOTH	RIBBED
2004	2012	Chevrolet	Colorado Crew Cab	—	—	72-40171	72-00171
2004	2012	Chevrolet	Colorado Reg/Ext Cab	—	—	72-40181	72-00181
1988	1990	Chevrolet	Pickup Full Size Long Bed	72-41101	72-01101	72-40101	72-00101
1988	1990	Chevrolet	Pickup Full Size Short Bed (Excl. Stepside)	72-41111	72-01111	72-40111	72-00111
2001	2005	Chevrolet	5-10 4Dr	—	—	72-40161	—
1994	2005	Chevrolet	5-10 Short Bed	—	—	72-40141	72-00141
2007	2013	Chevrolet	Silverado 1500 (5.8' Bed)(Excl. Classic)	72-41104	72-01104	72-40104	72-00104
2007	2013	Chevrolet	Silverado 1500 (8' Bed)(Excl. Dually)	72-41157	72-01157	72-40157	72-00157
1999	2006	Chevrolet	Silverado 1500/2500LD Long Bed (8' Bed)(Excl. Dually)	72-51101	72-01101	72-50101	72-00101
1999	2006	Chevrolet	Silverado 1500/2500LD Short Bed (5.8' Bed)	72-41151	72-01151	72-40151	72-00151
2014	2014	Chevrolet	Silverado 2500/3500HD (5.8' Bed)	72-41104	72-01104	72-40104	72-00104
2014	2014	Chevrolet	Silverado 2500/3500HD (8' Bed)(Excl. Dually)	72-41157	72-01157	72-40157	72-00157
2001	2006	Chevrolet	Silverado 2500/3500HD Long Bed (8' Bed)(Excl. Dually)	72-51101	72-01101	72-50101	72-00101
2001	2006	Chevrolet	Silverado 2500/3500HD Short Bed (5.8' Bed)	72-41151	72-01151	72-40151	72-00151
2007	2015	Chevrolet	Silverado Crew Cab Short Bed (5.8' Bed)	72-41114	72-01114	72-40114	72-00114
1997	2004	Dodge	Dakota	—	—	72-40421	72-00421
2006	2011	Dodge	Dakota Ext Cab (5.8' Bed)	—	—	72-40471	72-00471
2000	2004	Dodge	Dakota Quad Cab	—	—	72-40431	72-00431
2006	2011	Dodge	Dakota Quad Cab (5.4' Bed)	—	—	72-40461	72-00461
2002	2008	Dodge	Ram 1500 Long Bed	72-41441	72-01441	72-40441	72-00441
1994	2001	Dodge	Ram 1500 Long Bed	72-41401	72-01401	72-40401	72-00401
2002	2008	Dodge	Ram 1500 Short Bed	72-41451	72-01451	72-40451	72-00451
1994	2001	Dodge	Ram 1500 Short Bed	72-41411	72-01411	72-40411	72-00411
2002	2009	Dodge	Ram 2500/3500HD Long Bed	72-41441	72-01441	72-40441	72-00441
1994	2002	Dodge	Ram 2500/3500HD Long Bed	72-41401	72-01401	72-40401	72-00401
2002	2009	Dodge	Ram 2500/3500HD Short Bed	72-41451	72-01451	72-40451	72-00451
1994	2001	Dodge	Ram 2500/3500HD Short Bed	72-41411	72-01411	72-40411	72-00411
1980	1995	Ford	F-150/250/350 Full Size Long Bed	72-41601	72-01601	72-40601	72-00601
1980	1995	Ford	F-150/250/350 Full Size Short Bed	72-41611	72-01611	72-40611	72-00611
1997	1998	Ford	F-350 Long Bed	72-41601	72-01601	72-40601	72-00601
1997	1998	Ford	F-350 Short Bed	72-41611	72-01611	72-40611	72-00611
1993	2011	Ford	Ranger Short Bed (Excl. STX)	72-41621	72-01621	72-40621	72-00621
2004	2012	GMC	Canyon Crew Cab	—	—	72-40171	72-00171
2004	2012	GMC	Canyon Reg/Ext Cab	—	—	72-40181	72-00181
1988	1990	GMC	Pickup Full Size Long Bed	72-41101	72-01101	72-40101	72-00101
1988	1990	GMC	Pickup Full Size Short Bed (Excl. Stepside)	72-41111	72-01111	72-40111	72-00111
2007	2013	GMC	Sierra 1500 (5.8' Bed)(Excl. Classic)	72-41105	72-01105	72-40105	72-00105
2007	2013	GMC	Sierra 1500 (8' Bed)(Excl. Classic)(Excl. Dually)	72-41147	72-01147	72-40147	72-00147
2007	2013	GMC	Sierra 1500 Crew Cab Short Bed (5.8' Bed)	72-41115	72-01115	72-40115	72-00115
1999	2006	GMC	Sierra 1500/2500LD (5.8' Bed)	72-41151	72-01151	72-40151	72-00151
1999	2006	GMC	Sierra 1500/2500LD Long Bed (8' Bed)(Excl. Dually)	72-51101	72-01101	72-50101	72-00101
2007	2014	GMC	Sierra 2500/3500HD (5.8' Bed)	72-41105	72-01105	72-40105	72-00105
2007	2014	GMC	Sierra 2500/3500HD (8' Bed)(Excl. Dually)	72-41147	72-01147	72-40147	72-00147
2001	2006	GMC	Sierra 2500/3500HD (5.8' Bed)	72-41151	72-01151	72-40151	72-00151
2001	2006	GMC	Sierra 2500/3500HD Long Bed (8' Bed)(Excl. Dually)	72-51101	72-01101	72-50101	72-00101
1994	1997	Mazda	Pickup 5-Series	72-41621	72-01621	72-40621	72-00621
1998	2004	Nissan	Frontier King Cab	—	—	—	72-00801
1989	1995	Toyota	Pickup	—	—	72-00701	—
1996	2004	Toyota	Tacoma	—	—	72-00711	—
2001	2004	Toyota	Tacoma 4Dr	—	—	72-00721	—
2000	2005	Toyota	Tundra Short Bed	72-41721	72-01721	72-40721	72-00721

HITCH STEPS

304 STAINLESS STEEL / TEXTURED BLACK

- Step slides into any standard 2" receiver hitch
- Installs in seconds
- Easy access to the truck bed / roof rack
- Simple no-drill installation
- Receiver pin (sold separately) secures hitch bracket inside the receiver hitch
- Compliments Westin Nerf Step Bars / Running Boards

Note: May interfere with rear bumper parking sensors.

HDX DROP HITCH STEPS



FINISH: Textured Black Powder coat
MATERIAL: 410 Stainless Steel
WARRANTY: 5-Year

FINISH: Textured Black Powder Coat
MATERIAL: E-Coated Steel
WARRANTY: 3-Year

HDX STAINLESS DROP HITCH STEP 34" step with 2" receiver ¹	TEXTURED BLACK 56-100152
HDX DROP HITCH STEP 34" step with 2" receiver ¹	TEXTURED BLACK 56-10015

R5 HITCH STEP



FINISH: Polished
MATERIAL: 304 Stainless Steel
WARRANTY: Lifetime

FINISH: Textured Black Powder Coat
MATERIAL: Aluminum
WARRANTY: 3-Year

R5 HITCH STEP 27" step with 2" receiver ¹	POLISHED 21-50010	BLACK 21-50015
--	-----------------------------	--------------------------

PRO TRAXX 5 HITCH STEP



FINISH: Polished
MATERIAL: 304 Stainless Steel
WARRANTY: Lifetime

FINISH: Black Powder Coat
MATERIAL: E-Coated Steel
WARRANTY: 3-Year

PRO TRAXX 5 HITCH STEP 27" step with 2" receiver ¹	POLISHED 21-50010	BLACK 21-50015
---	-----------------------------	--------------------------

GRATE STEPS HITCH STEP



FINISH: Textured Black Powder Coat
MATERIAL: E-Coated Steel
WARRANTY: 3-Year

GRATE STEPS HITCH STEP 34" step with 2" receiver ¹	TEXTURED BLACK 27-70015
---	-----------------------------------

FOOTNOTES: 1. Requires Drilling. 2. May Interfere With Function Of Parking Sensor If Equipped.



PRO-SERIES TOOL BOXES

POLISHED / TEXTURED BLACK / BLACK POWDER COAT

- » Available in several dimensions: Standard, deep, wide and deep/wide
- » Beveled lid design
- » Under body support for added strength
- » Full rubber weather seal
- » Diamond tread back
- » Sturdy hinge point
- » Strong prop mounting points — lid and body
- » Full metal shield for props
- » Strut reinforced lid

FINISH: Polished

MATERIAL: Aluminum

WARRANTY: Limited Lifetime

FINISH: Black Textured and Black Powder Coat

MATERIAL: Aluminum

WARRANTY: Limited Lifetime

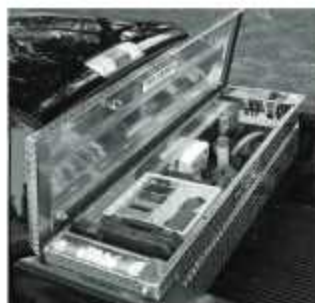

Under body support for added strength

BEDSAFE

DESCRIPTION	ALUMINUM PART NO.	APPROX. CUBIC FT. CAPACITY
Bedsafe 48in D x 20in W x 9.5in H single drawer	80-HBS306	5.28
Bedsafe 48in D x 30in W x 9.5in H single drawer	80-HBS307	7.92
Bedsafe 48in D x 40in W x 9.5in H single drawer	80-HBS308	10.56
Bedsafe 24in D x 30in W x 9.5in H single drawer	80-HBS312	3.98
Bedsafe 48in D x 20in W x 12in H single drawer	80-HBS336	6.87
Bedsafe 48in D x 40in W x 12in H single drawer	80-HBS338	13.33
Bedsafe 72in D x 40in W x 9.5in H single drawer	80-HBS340	15.8
Bedsafe 60in D x 40in W x 9.5in H single drawer	80-HBS341	13



JOB SITE BOX

DESCRIPTION	OVERALL DIMS				ALUMINUM	BLACK TEXTURED	APPROX. CUBIC FT. CAPACITY
	L	W	H	WT			
Job Site Box	50	12	12	31	80-JSB-100	80-JSB-100-BT	4.17



CONDUIT CARRIERS

DESCRIPTION	OVERALL DIMS				ALUMINUM	APPROX. CUBIC FT. CAPACITY
	L	W	H	WT		
Aluminum Conduit Carrier (w/install kit)	121.5	11	6	46	80-CC121	4.87
Aluminum Conduit Carrier Extension	6	11	6	4	80-CC006	0.23



CROSSOVER BOXES - FULL LID

DESCRIPTION	MODEL	OVERALL DIMS				BASE DIMS			ALUMINUM	BLACK TEXTURED	BLACK	APPROX. CUBIC FT. CAPACITY
		L	W	H	WT	L	W	H				
Full Lid Pro Series Full Size CrossOver Xtra Wide	Full Size - Xtra Wide	71	27	18	101	60	27	11	80-RB117FL	80-RB117FL-BT	80-RB117FL-B	18.97
Full Lid Pro Series Full Size CrossOver Xtra Deep (Xtra Wide w/ slant)	Full Size - Xtra Deep & Xtra Wide	71	23	23	105	60	23	16	80-RB120FL	80-RB120FL-BT	80-RB120FL-B	2 5.32
Full Lid Pro Series Full Size CrossOver Xtra Deep	Full Size - Xtra Deep	71	20	23	90	60	20	16	80-RB123FL	80-RB123FL-BT	80-RB123FL-B	18.9
Full Lid Pro Series Full Size CrossOver Standard	Full Size - Standard	71	20	18	84	60	20	11	80-RB127FL	80-RB127FL-BT	80-RB127FL-B	14.79
Full Lid Pro Series Mid Size / Down Size CrossOver - Long Bed Only	Mid Size - Down Size - Long Bed	62	20	18	75	51	20	11	80-RB137FL	80-RB137FL-BT	80-RB137FL-B	12.92
Full Lid Pro Series Full Size Step Side & Down Size - Shallow Depth	Full Size Step Side & Down Size	60	20	13	65	49	20	6	80-RB154FL	80-RB154FL-BT	80-RB154FL-B	9.03
Full Lid Pro Series Mid Size / Down Size CrossOver - LB & SB wide and shallow	Mid Size - Down Size	62	27	13	79	51	27	6	80-RB155FL	80-RB155FL-BT	80-RB155FL-B	12.50



CROSSOVER BOXES - FULL LID LOW PROFILE

DESCRIPTION	MODEL	OVERALL DIMS				BASE DIMS			ALUMINUM	BLACK TEXTURED	BLACK	APPROX. CUBIC FT. CAPACITY
		L	W	H	WT	L	W	H				
Low Profile Full Lid Pro Series Full Size CrossOver Standard	Full Size - Low Profile	71	20	15.5	80	60	20	11	80-RB121LP	80-RB121LP-BT	80-RB121LP-B	12.33





GULL WING BOXES

DESCRIPTION	OVERALL DIMS				BASE DIMS			ALUMINUM	BLACK TEXTURED	BLACK	APPROX. CUBIC FT. CAPACITY
	L	W	H	WT	L	W	H				
Gull Wing Lid Pro Series Full Size Xtra Wide	71	27	18	90	60	27	11	80-RB114GW	80-RB114GW-BT	80-RB114GW-B	19.91
Gull Wing Lid Pro Series Full Size Standard	71	20	18	75	60	20	11	80-RB124GW	80-RB124GW-BT	80-RB124GW-B	14.79
Gull Wing Lid Pro Series Mid Size / Down Size - Long Bed Only	62	20	18	70	51	20	11	80-RB134GW	80-RB134GW-BT	80-RB134GW-B	12.92
Gull Wing Lid Pro Series Full Size Step Side & Down Size - Shallow Depth	60	20	13	60	49	20	6	80-RB153GW	80-RB153GW-BT	80-RB153GW-B	9.03
Gull Wing Lid Pro Series Full Size Xtra Deep	71	20	23	85	60	20	16	80-RB157GW	80-RB157GW-BT	80-RB157GW-B	16.9
Gull Wing Lid Pro Series Full Size Xtra Deep / Xtra Wide w/ Slant	71	23	23	100	60	23	16	80-RB158GW	80-RB158GW-BT	80-RB158GW-B	27.41
Gull Wing Lid Pro Series Mid Size / Down Size - LB & SB - wide and shallow	62	27	13	60	51	27	6	80-RB159GW	80-RB159GW-BT	80-RB159GW-B	12.59



LOW PROFILE LOSIDER BOXES

DESCRIPTION	OVERALL DIMS				BASE DIMS			ALUMINUM	BLACK TEXTURED	BLACK	APPROX. CUBIC FT. CAPACITY
	L	W	H	WT	L	W	H				
Low Profile LoSider Side Rail 55in Box, Pro Series	56	19	11.75	52	56	13.5	7	80-RB178-9	80-RB178-9-BT	80-RB178-9-B	7.08
Low Profile LoSider Side Rail 47in Box, Pro Series	47	19	11.75	45	47	13.5	7	80-RB180-1	80-RB180-1-BT	80-RB180-1-B	5.94



CHEST BOXES

DESCRIPTION	OVERALL DIMS				BASE DIMS				ALUMINUM	BLACK TEXTURED	APPROX. CUBIC FT. CAPACITY
	L	W	H	WT	L	W	H	RISE			
Chest 54in, Pro Series	54	20	19	55	54	16	19	5	80-RB654	80-RB654-BT	11.88
Chest 60in, Pro Series	60	20	19	60	60	16	19	5	80-RB664	80-RB664-BT	13.19
Chest 47in, Pro Series	47	20	19	46	47	16	19	5	80-RB674	80-RB674-BT	10.34
Chest 60in, Pro Series - Xtra Wide	60	27	19	74	52	27	19	—	80-RB684	80-RB684-BT	17.81



LOSIDER SIDE RAIL BOXES

DESCRIPTION	OVERALL DIMS				BASE DIMS			ALUMINUM	BLACK TEXTURED	BLACK	APPROX. CUBIC FT. CAPACITY
	L	W	H	WT	L	W	H				
LoSider Side Rail 87in Box, Pro Series	87	16	13	72	87	10.5	6	80-RB164	80-RB164-BT	80-RB654-B	10.47
LoSider Side Rail 70in Box, Pro Series	70	16	13	65	70	10.5	6	80-RB172	80-RB172-BT	80-RB664-B	8.43
LoSider Side Rail 55in Box, Pro Series	56	16	13	52	56	10.5	6	80-RB174	80-RB174-BT	80-RB674-B	6.74
LoSider Side Rail 47in Box, Pro Series	47	16	13	45	47	10.5	6	80-RB184	80-RB184-BT	80-RB684-B	5.66



PORK CHOP BOXES

DESCRIPTION	OVERALL DIMS				ALUMINUM	BLACK TEXTURED	BLACK	APPROX. CUBIC FT. CAPACITY
	L	W	H	WT				
Pork Chop Driver Side 46in, Pro Series	45.25	9.25	19	22	80-RB160	80-RB160-BT	80-RB160-B	4.7
Pork Chop Pass Side 46in, Pro Series	45.25	9.25	19	22	80-RB161	80-RB161-BT	80-RB161-B	4.7
Pork Chop 46in Driver Side Wide, Pro Series	45.25	13	19	32	80-RB162	80-RB162-BT	80-RB162-B	6.61
Pork Chop 46in Pass Side Wide, Pro Series	45.25	13	19	32	80-RB163	80-RB163-BT	80-RB163-B	6.61



GOOSE NECK/FIFTH WHEEL TOOL BOXES

DESCRIPTION	OVERALL DIMS				ALUMINUM	BLACK TEXTURED	BLACK	APPROX. CUBIC FT. CAPACITY
	L	W	H	WT				
V Shape Goose Neck / Fifth Wheel 57in Tailgate Box, 1 Drawer / 2 Rear Swing Doors, Pro Series	57	19	19	53	80-RB257D	80-RB257D-BT	80-RB257D-B	8.11



MAXIMUS CHEST BOXES

DESCRIPTION	OVERALL DIMS				BASE DIMS			ALUMINUM	BLACK TEXTURED	BLACK	APPROX. CUBIC FT. CAPACITY
	L	W	H	WT	L	W	H				
Maximus 24in Chest, Pro Series	48	24	24	76	48	22	17	80-RB624	80-RB624-BT	80-RB624-B	16
Maximus 30in Chest, Pro Series	48	30	30	95	48	28	17	80-RB630	80-RB630-BT	80-RB630-B	25





HIGH CAPACITY STAKE BED CONTRACTOR BOXES

DESCRIPTION	OVERALL DIMS				ALUMINUM	BLACK TEXTURED	BLACK	APPROX. CUBIC FT. CAPACITY
	L	W	H	WT				
High 72in Stake Bed Contractor TopSider w/ Doors, Pro Series	72	20	24	80	80-TB400-72	80-TB400-72-BT	80-TB400-72-B	20
High 72in Stake Bed Contractor TopSider w/ Base Drawers, Pro Series	72	20	24	96	80-TB400-72-BD	80-TB400-72-BD-BT	80-TB400-72-BD-B	20
High 96in Stake Bed Contractor TopSider w/ Doors, Pro Series	96	20	24	100	80-TB400-96D	80-TB400-96D-BT	80-TB400-96D-B	25.67
High 96in Stake Bed Contractor TopSider w/ Base Drawers, Pro Series	96	20	24	124	80-TB400-96D-BD	80-TB400-96D-BD-BT	80-TB400-96D-BD-B	25.67



CONTRACTOR TOP SIDER BOXES

DESCRIPTION	OVERALL DIMS				ALUMINUM	BLACK TEXTURED	BLACK	APPROX. CUBIC FT. CAPACITY
	L	W	H	WT				
Contractor TopSider 48in w/ Doors, Pro Series	48	13.5	21	40	80-TBS200-48	80-TBS200-48-BT	80-TBS200-48-B	7.68
Contractor TopSider 60in w/ Doors, Pro Series	60	13.5	21	44	80-TBS200-60	80-TBS200-60-BT	80-TBS200-60-B	10.21
Contractor TopSider 72in w/ Doors, Pro Series	72	13.5	21	48	80-TBS200-72	80-TBS200-72-BT	80-TBS200-72-B	12.45
Contractor TopSider 80in w/ Doors, Pro Series	80	13.5	21	58	80-TBS200-80D	80-TBS200-80D-BT	80-TBS200-80D-B	14.44
Contractor TopSider 90in w/ Doors, Pro Series	90	13.5	21	63	80-TBS200-90D	80-TBS200-90D-BT	80-TBS200-90D-B	14.77
Contractor TopSider 96in w/ Doors, Pro Series	96	13.5	21	73	80-TBS200-96D	80-TBS200-96D-BT	80-TBS200-96D-B	15.75
Contractor TopSider 48in w/ Drawers & Doors, Pro Series	48	13.5	21	45	80-TBS200-48-BD	80-TBS200-48-BD-BT	80-TBS200-48-BD-B	7.68
Contractor TopSider 60in w/ Drawers & Doors, Pro Series	60	13.5	21	52	80-TBS200-60-BD	80-TBS200-60-BD-BT	80-TBS200-60-BD-B	10.21
Contractor TopSider 72in w/ Drawers & Doors, Pro Series	72	13.5	21	58	80-TBS200-72-BD	80-TBS200-72-BD-BT	80-TBS200-72-BD-B	12.45
Contractor TopSider 80in w/ Drawers & Doors, Pro Series	80	13.5	21	68	80-TBS200-80D-BD	80-TBS200-80D-BD-BT	80-TBS200-80D-BD-B	14.44
Contractor TopSider 90in w/ Drawers & Doors, Pro Series	90	13.5	21	73	80-TBS200-90D-BD	80-TBS200-90D-BD-BT	80-TBS200-90D-BD-B	14.77
Contractor TopSider 96in w/ Drawers & Doors, Pro Series	96	13.5	21	83	80-TBS200-96D-BD	80-TBS200-96D-BD-BT	80-TBS200-96D-BD-B	15.75



CONTRACTOR UNDER BODY BOXES

DESCRIPTION	OVERALL DIMS				ALUMINUM	BLACK TEXTURED	BLACK	APPROX. CUBIC FT. CAPACITY
	L	W	H	WT				
Under Body 24in x 20in w/ Top Drawer	24	18	20	29	80-UB24-20TD	80-UB24-20TD-BT	80-UB24-20TD-B	5
Under Body 30in x 20in w/ Top Drawer	30	18	20	35	80-UB30-20TD	80-UB30-20TD-BT	80-UB30-20TD-B	6.25
Under Body 36in x 20in w/ Top Drawer	36	18	20	38	80-UB36-20TD	80-UB36-20TD-BT	80-UB36-20TD-B	7.5
Under Body 48in x 20in w/ Top Drawer	48	18	20	45	80-UB48-20TD	80-UB48-20TD-BT	80-UB48-20TD-B	10
Under Body 60in x 20in w/ Top Drawer	60	18	20	67	80-UB60-20TD	80-UB60-20TD-BT	80-UB60-20TD-B	12.5



HD STEP BOXES

DESCRIPTION	INDIV. DIMS				ALUMINUM	APPROX. CUBIC FT. CAPACITY
	L	W	H	WT		
HD Step Box 12in	28.375	22	12	36	80-HSB12	5.87
HD Step Box 18in	28.375	22	18	46	80-HSB18	8.39
HD Step Box 24in	28.375	22	24	56	80-HSB24	10.91
HD Step Box 30in	28.375	22	30	66	80-HSB30	13.43



HD UNDER BODY DROP DOWN DOOR BOXES

DESCRIPTION	INDIV. DIMS				ALUMINUM	APPROX. CUBIC FT. CAPACITY
	L	W	H	WT		
HD Under Body 18in x 18in drop down door	18	18	18	31	80-HUB1818	4.4
HD Under Body 18in x 24in drop down door	24	18	18	33	80-HUB1824	5.72
HD Under Body 18in x 30in drop down door	30	18	18	42	80-HUB1830	7.04
HD Under Body 18in x 36in drop down door	36	18	18	45	80-HUB1836	8.36
HD Under Body 18in x 48in drop down door	48	18	18	56	80-HUB1848	11
HD Under Body 18in x 60in drop down door	60	18	18	70	80-HUB1860	13.63
HD Under Body 24in x 18in drop down door	18	24	24	48	80-HUB2418	7.52
HD Under Body 24in x 24in drop down door	24	24	24	50	80-HUB2424	9.76
HD Under Body 24in x 30in drop down door	30	24	24	58	80-HUB2430	12.04
HD Under Body 24in x 36in drop down door	36	24	24	72	80-HUB2436	14.29
HD Under Body 24in x 48in drop down door	48	24	24	84	80-HUB2448	18.61
HD Under Body 24in x 60in drop down door	60	24	24	96	80-HUB2460	23.32
HD Under Body 24in x 72in drop down door	72	24	24	107	80-HUB2472	27.84





HD UNDER BODY SWING DOOR BOXES

DESCRIPTION	INDIV. DIMS				ALUMINUM	APPROX. CUBIC FT. CAPACITY
	L	W	H	WT		
HD Under Body 18in x 18in Swing Door	18	18	18	25	80-HBD1818	4.4
HD Under Body 18in x 24in Swing Door	24	18	18	33	80-HBD1824	5.72
HD Under Body 18in x 30in Swing Door	30	18	18	39	80-HBD1830	7.04
HD Under Body 24in x 30in Swing Door w/ 3 pt. Latch	30	24	24	61	80-HBD2430	12.04
HD Under Body 18in x 36in Double Swing Doors w/ 3 pt. Latch	36	18	18	45	80-HBD1836	8.36
HD Under Body 18in x 48in Double Swing Doors w/ 3 pt. Latch	48	18	18	58	80-HBD1848	11
HD Under Body 18in x 60in Double Swing Doors w/ 3 pt. Latch	60	18	18	71	80-HBD1860	13.63
HD Under Body 24in x 36in Double Swing Doors w/ 3 pt. Latch	36	24	24	66	80-HBD2436	14.29
HD Under Body 24in x 48in Double Swing Doors w/ 3 pt. Latch	48	24	24	70	80-HBD2448	18.81
HD Under Body 24in x 60in Double Swing Doors w/ 3 pt. Latch	60	24	24	81	80-HBD2460	23.32



UNDER BODY BOX MOUNTING BRACKETS

DESCRIPTION	DIMENSIONS				ALUMINUM
	L	W	H	WT	
Under Body Bracket 18in (1 pair)	18	2	18	6	80-HBK18
Under Body Bracket 24in (1 pair)	24	2	24	10	80-HBK24

TOOL BOX DIVIDERS

DESCRIPTION	DIMENSIONS				
	L	W	H	WT	DIVIDERS
Drawer Divider for TBS200-BD Series Models (1 pc) - Yellow	11	0.063	3.5	1	80-D11
Drawer Divider for UB-TD Series Models (1 pc) - Yellow	15	0.063	3.5	1	80-D15
Drawer Divider for TB400-BD Series Models (1 pc) - Yellow	18	0.063	3.5	1	80-D18



HD TOPSIDER BOXES

DESCRIPTION	INDIV. DIMS				ALUMINUM	APPROX. CUBIC FT. CAPACITY
	L	W	H	WT		
HD TopSider 13in x 48in w/ Flip Up Door	48	13	16	47	80-HTB48	7.38
HD TopSider 13in x 60in w/ Flip Up Door	60	13	16	59	80-HTB60	9.15
HD TopSider 13in x 72in w/ Flip Up Door	72	13	16	69	80-HTB72	10.92
HD TopSider 13in x 88in w/ Flip Up Doors	88	13	16	82	80-HTB88	13.28
HD TopSider 13in x 96in w/ Flip Up Doors	96	13	16	87	80-HTB96	14.46



HIGH CAPACITY HD TOPSIDER BOXES

DESCRIPTION	INDIV. DIMS				ALUMINUM	APPROX. CUBIC FT. CAPACITY
	L	W	H	WT		
High Capacity HD TopSider 16in x 72in w/ Flip Up Door	72	16	18	77	80-HTB72C	14.65
High Capacity HD TopSider 16in x 88in w/ Flip Up Doors	88	16	18	95	80-HTB88C	17.81
High Capacity HD TopSider 16in x 96in w/ Flip Up Doors	96	16	18	102	80-HTB96C	19.4



HD UNDER BODY BOXES

DESCRIPTION	INDIV. DIMS				ALUMINUM	APPROX. CUBIC FT. CAPACITY
	L	W	H	WT		
HD Under Body 24in x 24in w/ Top & Base Drawers	24	24	30	68	80-HDD30	10
HD Under Body 24in x 24in w/ Top & Base Drawers	24	24	24	68	80-HDD24	9.4
HD Under Body 24in x 36in w/ Top & Base Drawers	36	24	24	101	80-HDD36	13.74



	Performance2x Double Row Light Bar	141
	EF2 Double Row Light Bar	141
	B-Force Double Row Light Bar	142
	B-Force Single Row Light Bar	142
	Xtreme Single Row Light Bar	143
	Fusion5	143
	HyperQ B-Force / HyperQ Auxiliary Lights	144
	FM4Q Flush Mount Auxiliary Lights	144
	FM6 Flush Mount Auxiliary Lights	144
	Ultra Auxiliary Lights	145
	Axis Auxiliary Lights	145
	Quadrant Auxiliary Lights	145
	Round / Square LED Work Utility Lights	146

PERFORMANCE2X

LOW PROFILE DOUBLE ROW / POWER OUTPUT: 12 – 300 WATTS

- » Face sizes available in 2", 4", 6", 10", 20", 30", 40" and 50" lengths
- » 3W LED chips
- » 6063 extruded aluminum housing with die-cast ends
- » Dust and moisture resistant lens
- » Gore pressure equalizing vent
- » Raw lumens: 1,500 - 23,000
- » Includes wiring harness with connector, switch, relay and in-line fuse and mounting hardware
- » Limited lifetime warranty
- » Available in floor or flex beam

WIRING HARNESS INCLUDED

**PERFORMANCE2X**

PART NO.	POWER OUTPUT	BEAM TYPE	LEDS	FACE SIZE	RAW LUMENS	BEAM DISTANCE	OPERATING VOLTAGE
09-12230-20F	60	Flood	20 x 3W Osram	10"	5700	1425	9V-30V
09-12230-20S	60	Flex	20 x 3W Osram	10"	5700	3775	9V-30V

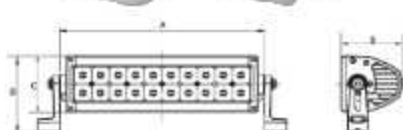

MODEL	A	B	C	D
09-12230-4	3.6 in.	3.5 in.	3.2 in.	4.4 in.
09-12230-8	5.6 in.	3.5 in.	3.2 in.	4.4 in.
09-12230-12	7.6 in.	3.5 in.	3.2 in.	4.4 in.
09-12230-20	11.7 in.	3.5 in.	3.2 in.	4.4 in.
09-12230-40	21.7 in.	3.5 in.	3.2 in.	4.4 in.
09-12230-60	31.7 in.	3.5 in.	3.2 in.	4.4 in.
09-12230-80	41.8 in.	3.5 in.	3.2 in.	4.4 in.
09-12230-100	51.8 in.	3.5 in.	3.2 in.	4.4 in.

EF2

LOW PROFILE DOUBLE ROW / POWER OUTPUT: 36 – 280 WATTS

- » Face sizes available in 6", 12", 20", 30", 40" and 50" lengths
- » 3W LED chips
- » Dust and moisture resistant lens
- » Raw lumens: 2,160 – 19,200
- » Includes mounting hardware and pigtail connector
- » Limited lifetime warranty
- » Available in combo or spot beam

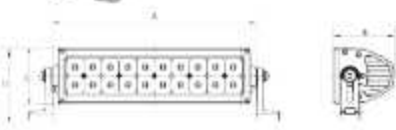

PIGTAIL CONNECTOR

**EF2**

PART NO.	POWER OUTPUT	BEAM TYPE	LEDS	FACE SIZE	RAW LUMENS	BEAM DISTANCE	OPERATING VOLTAGE
09-13206C	36	Combo	12 x 3W Epistar	6"	2160	1050	10V-30V
09-13206S	36	Spot	12 x 3W Epistar	6"	2160	2650	10V-30V
09-13212C	72	Combo	24 x 3W Epistar	12"	3600	1025	10V-30V
09-13212S	72	Spot	24 x 3W Epistar	12"	3600	3075	10V-30V
09-13220C	120	Combo	40 x 3W Epistar	20"	6000	1235	10V-30V
09-13220S	120	Spot	40 x 3W Epistar	20"	6000	3210	10V-30V
09-13230C	180	Combo	60 x 3W Epistar	30"	10000	1550	10V-30V
09-13230S	180	Spot	60 x 3W Epistar	30"	10000	3960	10V-30V
09-13240C	240	Combo	80 x 3W Epistar	40"	14800	2430	10V-30V
09-13240S	240	Spot	80 x 3W Epistar	40"	14800	6950	10V-30V
09-13250C	300	Combo	100 x 3W Epistar	50"	19200	2655	10V-30V
09-13250S	300	Spot	100 x 3W Epistar	50"	19200	7520	10V-30V

MODEL	A	B	C	D
09-13206	8.7 in.	3.4 in.	3.2 in.	4.9 in.
09-13212	12.7 in.	3.4 in.	3.2 in.	4.9 in.
09-13220	22.7 in.	3.4 in.	3.2 in.	4.9 in.
09-13230	32.7 in.	3.4 in.	3.2 in.	4.9 in.
09-13240	42.8 in.	3.4 in.	3.2 in.	4.9 in.
09-13250	49.8 in.	3.4 in.	3.2 in.	4.9 in.

B-FORCE / DOUBLE ROW

BLACK FACE WITH DIAMOND PLATE PATTERN / DOUBLE ROW / POWER OUTPUT: 12 – 300 WATTS

- » Face sizes available in 2", 4", 6", 10", 12", 20", 30", 40" and 50" lengths
- » 3W LED chips
- » 6063 extruded aluminum housing with die-cast ends
- » Dust and moisture resistant lens
- » Raw lumens: 1,080 - 27,000
- » Includes mounting hardware and pigtail connector
- » Limited lifetime warranty
- » Available in flood or combo beam
- » Registered U.S. Patent



BLACK DIAMOND PLATE PATTERN



6" OR 10" HX B-FORCE FLUSH MOUNT LED KIT AVAILABLE ... PAGE 62

PIGTAIL CONNECTOR

B-FORCE

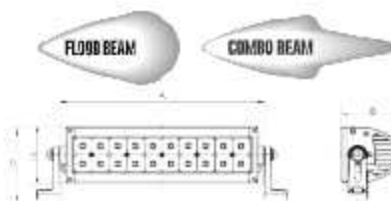

PART NO.	POWER OUTPUT	BEAM TYPE	LEDS	FACE SIZE	RAW LUMENS	BEAM DISTANCE	OPERATING VOLTAGE
09-12212-4F	12	Flood	4 x 3w Cree	2"	1080	104	9V-30V
09-12212-6F	24	Flood	6 x 3w Cree	4"	2160	123	9V-30V
09-12212-12C	36	Combo	12 x 3w Cree	6"	3240	126	9V-30V
09-12212-20C	60	Combo	20 x 3w Cree	10"	6400	126	9V-30V
09-12212-24C	72	Combo	24 x 3w Cree	12"	8430	110	9V-30V
09-12212-40C	120	Combo	40 x 3w Cree	20"	10800	849	9V-30V
09-12212-60C	180	Combo	60 x 3w Cree	30"	16200	909	9V-30V
09-12212-80C	240	Combo	80 x 3w Cree	40"	21600	1109	9V-30V
09-12212-100C	300	Combo	100 x 3w Cree	50"	27000	1154	9V-30V

MODEL	A	B	C	D
09-12212-4	4.1 in.	3.4 in.	3.1 in.	4.9 in.
09-12212-6	6.5 in.	3.4 in.	3.1 in.	4.8 in.
09-12212-12	8.1 in.	3.4 in.	3.1 in.	4.8 in.
09-12212-20	12.1 in.	3.4 in.	3.1 in.	4.8 in.
09-12212-24	14.1 in.	3.4 in.	3.1 in.	4.8 in.
09-12212-40	22.2 in.	3.4 in.	3.1 in.	4.8 in.
09-12212-60	32.2 in.	3.4 in.	3.1 in.	4.8 in.
09-12212-80	42.3 in.	3.4 in.	3.1 in.	4.8 in.
09-12212-100	52.2 in.	3.4 in.	3.1 in.	4.8 in.

B-FORCE / SINGLE ROW

BLACK FACE WITH DIAMOND PLATE PATTERN / SINGLE ROW / POWER OUTPUT: 30 – 250 WATTS

- » Face sizes available in 6", 10", 20", 30", 40" and 50" lengths
- » 5W LED chips
- » 6063 extruded aluminum housing with die-cast ends
- » Dust and moisture resistant lens
- » Gore pressure equalizing vent
- » Raw lumens: 2,980 - 24,900
- » Includes mounting hardware and pigtail connector
- » Limited lifetime warranty
- » Available in flood or combo beam
- » Registered U.S. Patent



BLACK DIAMOND PLATE PATTERN



PIGTAIL CONNECTOR

B-FORCE

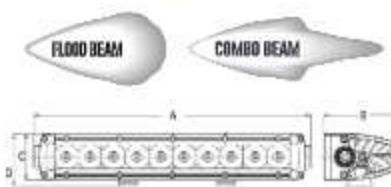

PART NO.	POWER OUTPUT	BEAM TYPE	LEDS	FACE SIZE	RAW LUMENS	BEAM DISTANCE	OPERATING VOLTAGE
09-12211-6F	30	Flood	6 x 5w Cree	6"	2980	299	9V-30V
09-12211-10C	60	Combo	10 x 5w Cree	10"	4960	384	9V-30V
09-12211-20C	100	Combo	20 x 5w Cree	20"	9920	625	9V-30V
09-12211-30C	150	Combo	30 x 5w Cree	30"	14840	635	9V-30V
09-12211-40C	200	Combo	40 x 5w Cree	40"	19820	735	9V-30V
09-12211-50C	250	Combo	50 x 5w Cree	50"	24900	807	9V-30V

MODEL	A	B	C	D
09-12211-6	7.6 in.	3.4 in.	1.9 in.	3.7 in.
09-12211-10	11.6 in.	3.4 in.	1.9 in.	3.7 in.
09-12211-20	21.4 in.	3.4 in.	1.9 in.	3.7 in.
09-12211-30	31.3 in.	3.4 in.	1.9 in.	3.7 in.
09-12211-40	41.1 in.	3.4 in.	1.9 in.	3.7 in.
09-12211-50	50.9 in.	3.4 in.	1.9 in.	3.7 in.

XTREME

LOW PROFILE SINGLE ROW / POWER OUTPUT: 30 - 250 WATTS

- Face sizes available in 6", 10", 20", 30", 40" and 50" lengths
- 5W LED chips
- 6063 extruded aluminum housing
- Includes wiring harness
- Gore pressure equalizing vent
- Raw lumens: 3,000 - 21,500
- Limited lifetime warranty
- Available in flood flex beam



WIRING HARNESS INCLUDED

FLOOD BEAM

FLEX BEAM



PART NO.	POWER OUTPUT	BEAM TYPE	LEDS	FACE SIZE	RAW LUMENS	BEAM DISTANCE	OPERATING VOLTAGE	MODEL	A	B	C	D
09-12270-10F	50	Flood	10 x 5W Cree	10"	4300	384	9V-30V	09-12270-6	7.6 in.	3.4 in.	1.9 in.	3.7 in.
09-12270-20F	100	Flood	20 x 5W Cree	20"	9600	525	9V-30V	09-12270-10	11.6 in.	3.4 in.	1.9 in.	3.7 in.
09-12270-20F	100	Flex	20 x 5W Cree	20"	9600	722	9V-30V	09-12270-20	21.4 in.	3.4 in.	1.9 in.	3.7 in.
09-12270-30F	150	Flood	30 x 5W Cree	30"	14940	838	9V-30V	09-12270-30	31.3 in.	3.4 in.	1.9 in.	3.7 in.
09-12270-30F	150	Flex	30 x 5W Cree	30"	14940	869	9V-30V	09-12270-40	41.1 in.	3.4 in.	1.9 in.	3.7 in.
09-12270-40F	200	Flex	40 x 5W Cree	40"	19820	1020	9V-30V	09-12270-50	50.9 in.	3.4 in.	1.9 in.	3.7 in.

FUSION5

SINGLE ROW / POWER OUTPUT: 15 WATTS

- Set of (2) Fusion5 LED lights
- Dimensions: 5.5" x 1.8"
- 3W LED chips
- Dust and moisture resistant lens
- Compact light ideal for ATV/UTV
- Raw lumens: 1,850
- Pivoting base mount bracket
- Includes wiring harness with connector, switch, relay and in-line fuse and mounting hardware
- Limited lifetime warranty
- Available in flex beam



WIRING HARNESS INCLUDED

AVAILABLE IN PAIR PACK ONLY

FLEX BEAM

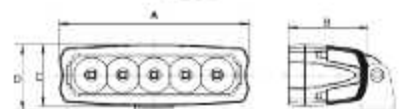

PART NO.	POWER OUTPUT	BEAM TYPE	LEDS	FACE SIZE	RAW LUMENS	BEAM DISTANCE	OPERATING VOLTAGE	MODEL	A	B	C	D
09-12232-PR	15	Flex	5 x 3W Epistar	5.5"	1850	250	9V-30V	09-12232	5.6 in.	2.3 in.	1.6 in.	1.9 in.

HYPERQB-FORCE

LED AUXILIARY LIGHTS / POWER OUTPUT: 20 WATTS

- » Dimensions: 3.2" x 3.0"
- » Black diamond tread faceplates
- » Black plated stainless hardware
- » 5W LED chips
- » Dust and moisture resistant lens
- » Raw Lumens: 1,080
- » Set of 2
- » Pivoting base mount bracket
- » Includes wiring harness with connector, switch, relay and in-line fuse and mounting hardware
- » Limited lifetime warranty
- » Available in spot beam



AVAILABLE IN PAIR PACK ONLY

PART NO.	POWER OUTPUT	BEAM TYPE	LEDS	RAW LUMENS
09-12205A-PR	20W	Spot	4 x 5 Cree	1080
09-12205B-PR	20W	Flood	4 x 5 Cree	1080



SPOT BEAM

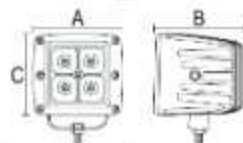

MODEL	A	B	C
09-12205A-PR	3.2 in.	3.2 in.	3.0 in.

HYPERQ

LED AUXILIARY LIGHTS / POWER OUTPUT: 20 WATTS

- » Dimensions: 3.2" x 3.0"
- » 5W LED chips
- » Dust and moisture resistant lens
- » Raw Lumens: 1,080
- » Set of 2
- » Pivoting base mount bracket
- » Includes wiring harness with connector, switch, relay and in-line fuse and mounting hardware
- » Limited lifetime warranty
- » Available in spot beam



AVAILABLE IN PAIR PACK ONLY

PART NO.	POWER OUTPUT	BEAM TYPE	LEDS	RAW LUMENS
09-12200A-PR	20	Spot	4 x 5W Cree	1080
09-12200B-PR	20	Flood	4 x 5W Cree	1080



SPOT BEAM

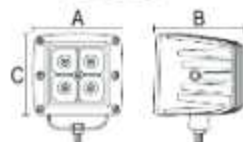

MODEL	A	B	C
09-12200A-PR	3.2 in.	3.2 in.	3.0 in.

FM4Q

LED FLUSH MOUNT / POWER OUTPUT: 12 WATTS

- » Dimensions: 4.8" x 3.6"
- » 3W LED chips
- » Die-cast aluminum housing
- » Dust and moisture resistant lens
- » Raw Lumens: 1,080
- » Set of 2
- » Includes mounting hardware and pigtail connectors
- » Limited lifetime warranty
- » Available in flood beam



AVAILABLE IN PAIR PACK ONLY

PART NO.	POWER OUTPUT	BEAM TYPE	LEDS	RAW LUMENS
09-1218FM4	12W	Flood	4 x 3W	1080



FLOOD BEAM

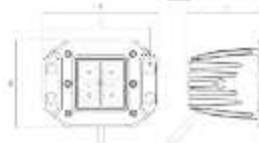

MODEL	A	B	C	D
09-1218FM4	4.8 in.	3.1 in.	3.6 in.	4.0 in.

FM6

LED FLUSH MOUNT / POWER OUTPUT: 18 WATTS

- » Dimensions: 7.7" x 2.4"
- » 3W LED chips
- » Die-cast aluminum housing
- » Dust and moisture resistant lens
- » Raw Lumens: 1,320
- » Set of 2
- » Includes mounting hardware and pigtail connectors
- » Limited lifetime warranty
- » Available in flood beam



AVAILABLE IN PAIR PACK ONLY

PART NO.	POWER OUTPUT	BEAM TYPE	LEDS	RAW LUMENS
09-1918FM6	18W	Flood	6 x 3W	1320



FLOOD BEAM

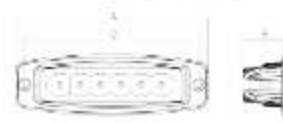

MODEL	A	B	C	D
09-1918FM6	7.7 in.	1.7 in.	2.4 in.	6.9 in.

ULTRA

LED AUXILIARY LIGHT / POWER OUTPUT: 80 WATTS

- » Dimensions: 6.5" round
- » 10W LED chips
- » Dust and moisture resistant lens
- » Raw Lumens: 7,200
- » Die-cast aluminum housing
- » Pivoting base mount bracket
- » Includes mounting hardware and pigtail connector
- » Limited lifetime warranty
- » Available in flood or spot beam



PIGTAIL CONNECTOR

PART NO.	POWER OUTPUT	BEAM TYPE	LEDS	FACE SIZE	RAW LUMENS	BEAM DISTANCE	OPERATING VOLTAGE
09-12010A	80	Spot	8 x 10W Cree	6.5"	7200	1875	9V-30V

ULTRA

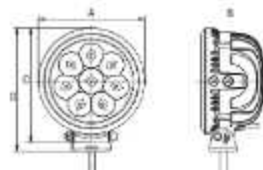

MODEL	A	B	C	D
09-12010	6.5 in.	5.9 in.	7.0 in.	7.5 in.

AXIS

LED AUXILIARY LIGHTS / POWER OUTPUT: 27 WATTS

- » Dimensions: round (4.7") and square (4.6")
- » 3W LED chips
- » Dust and moisture resistant lens
- » Raw Lumens: 2,025
- » Die-cast aluminum housing
- » Pivoting base mount bracket
- » Includes mounting hardware and pigtail connector
- » Limited lifetime warranty
- » Available in flood or spot beam



PIGTAIL CONNECTOR WIRING HARNESS INCLUDED AVAILABLE IN PAIR PACK ONLY

PART NO.	POWER OUTPUT	BEAM TYPE	LEDS	FACE SIZE	RAW LUMENS	BEAM DISTANCE	OPERATING VOLTAGE
09-12007A-PR	27	Spot	9 x 3W Ceram	4.7"	2025	850	9V-30V
09-12007B-PR	27	Flood	9 x 3W Ceram	4.7"	2025	366	9V-30V
09-12219A-PR	27	Spot	9 x 3W Ceram	4.6" x 4.6"	2025	935	9V-30V
09-12219B-PR	27	Flood	9 x 3W Ceram	4.6" x 4.6"	2025	410	9V-30V

AXIS

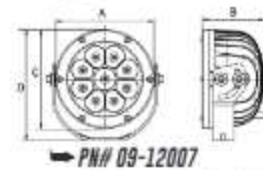

PN# 09-12007



PN# 09-12219

MODEL	A	B	C	D
09-12007	4.7 in.	3.0 in.	4.7 in.	5.3 in.
09-12219	4.6 in.	2.9 in.	4.6 in.	5.5 in.

QUADRANT

COMPACT LED AUXILIARY LIGHT / POWER OUTPUT: 20 WATTS

- » Dimensions: 3" x 2.6"
- » 5W LED chips
- » Dust and moisture resistant lens
- » Raw Lumens: 1,820
- » Die-cast aluminum housing
- » Pivoting base mount bracket
- » Includes mounting hardware and pigtail connector
- » Limited lifetime warranty
- » Available in flood or spot beam



PIGTAIL CONNECTOR WIRING HARNESS INCLUDED AVAILABLE IN PAIR PACK ONLY

PART NO.	POWER OUTPUT	BEAM TYPE	LEDS	FACE SIZE	RAW LUMENS	BEAM DISTANCE	OPERATING VOLTAGE
09-12252A-PR	20	Spot	4 x 5W Cree	3.0" x 2.6"	1820	429	9V-30V
09-12252B-PR	20	Flood	4 x 5W Cree	3.0" x 2.6"	1820	238	9V-30V

QUADRANT

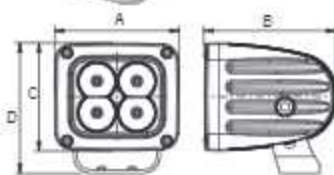

MODEL	A	B	C	D
09-12252	3.0 in.	3.1 in.	2.6 in.	3.1 in.

ROUND LED

LED WORK UTILITY LIGHTS / POWER OUTPUT: 18 – 27 WATTS

- » Dimensions: 4.6" round (6-LED configuration)
- » Dimensions: 4.9" round (9-LED configuration)
- » 3W LED chips
- » Dust and moisture resistant lens
- » Raw Lumens: 960 - 1,450
- » Pivoting base mount bracket
- » Includes mounting hardware and pigtail connector
- » Limited lifetime warranty
- » Available in flood or spot beam



PIGTAIL CONNECTOR



PART NO.	POWER OUTPUT	BEAM TYPE	LEDS	FACE SIZE	RAW LUMENS	BEAM DISTANCE	OPERATING VOLTAGE
09-12005A	18	Spot	6 x 3W Epistar	4.6"	960	300	9V-30V
09-12006	18	Flood	6 x 3W Epistar	4.6"	960	100	9V-30V
09-12006A	27	Spot	9 x 3W Epistar	4.9" x 5.4"	1450	325	9V-30V
09-12006B	27	Flood	9 x 3W Epistar	4.9" x 5.4"	1450	165	9V-30V

PART NO.	A	B	C	D
09-12005	4.6 in.	1.7 in.	5.0 in.	5.4 in.
09-12006	4.9 in.	2.0 in.	5.4 in.	5.8 in.

SQUARE LED

LED WORK UTILITY LIGHTS / POWER OUTPUT: 15 – 27 WATTS

- » Dimensions: 4.3" x 5" (5-LED configuration)
- » Dimensions: 4.6" x 5.3" (9-LED configuration)
- » 3W LED chips
- » Dust and moisture resistant lens
- » Raw Lumens: 800 - 1,450
- » Pivoting base mount bracket
- » Includes mounting hardware and pigtail connector
- » Limited lifetime warranty
- » Available in flood or spot beam



PIGTAIL CONNECTOR

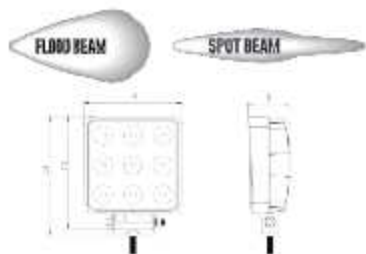

PART NO.	POWER OUTPUT	BEAM TYPE	LEDS	FACE SIZE	RAW LUMENS	BEAM DISTANCE	OPERATING VOLTAGE
09-12210A	15	Spot	5 x 3W Epistar	4.3" x 5.0"	800	265	9V-30V
09-12210	15	Flood	5 x 3W Epistar	4.3" x 5.0"	800	120	9V-30V
09-12211A	27	Spot	9 x 3W Epistar	4.6" x 5.3"	1450	325	9V-30V
09-12211B	27	Flood	9 x 3W Epistar	4.6" x 5.3"	1450	175	9V-30V

PART NO.	A	B	C	D
09-12210	4.3 in.	1.6 in.	5.0 in.	5.4 in.
09-12211	4.6 in.	2.0 in.	5.3 in.	5.7 in.

LED ACCESSORIES/HARNESSES

LED ACCESSORIES

DESCRIPTION	PART NO.
Bottom Mounts For LED Light Series 09-12251	09-2010
Bull Bar 20 Inch Light Bar Bracket	32-0045
Contour 5.9" Bull Bar 30 Inch Curved LED Light Bar Bracket	32-20055
HD Bar Clamp Brackets, 2"	32-20005
HDX Grille Guard LED Light Bracket For 20 Or 30 Inch LED Bar, Powder Coated Black	57-0015
HDX Grille Guard LED Light Bracket For 20 Or 30 Inch LED Bar, Polished Stainless	57-0010
HDX Light Clamps (Set Of 2), Powder Coated Black	57-0009
HDX Light Clamps (Set Of 2), Polished Stainless	57-0000

LED ACCESSORIES

DESCRIPTION	PART NO.
HLR LED Auxiliary Light Mount For HLR Truck Racks	57-89045
HLR LED Light Bar Brackets For HLR Truck Racks	57-89035

LED HARNESSES

DESCRIPTION	PART NO.
11 ft. long, 14 gauge includes 15 amp fuse in hard plastic wire loom cover and single connector	09-12000-1
11 ft. long, 12 gauge includes 30 amp fuse in hard plastic wire loom cover and single connector	09-12000-5
14 ft. long, 14 gauge includes 20 amp fuse in hard plastic wire loom cover w/pigtail to connect 2 lights	09-12000-8

SURE FIT FLOOR LINERS/FRONT ROW

MOLDED RUBBERIZED COPOLYMER



- » Full coverage design
- » Rigid core and tactile surface
- » Protects carpet for longevity
- » Equipped with factory retention hook openings
- » Application specific

- » Door seal coverage on most applications
 - » Available for most trucks and SUV/CUVs
- NOTE: Sure-Fit Floor Mats are designed for vehicles with carpeted floors.

FINISH: Black, Gray or Tan
 MATERIAL: Molded Rubberized Copolymer
 WARRANTY: Limited Lifetime



START	END	MAKE	MODEL	POSITION	BLACK	GRAY	TAN
2002	2006	Cadillac	Escalade	Front	72-110030	72-120030	72-130030
2007	2014	Cadillac	Escalade (Excl. Hybrid)	Front	72-110001	-	72-130001
2016	2020	Cadillac	Escalade	Front	72-110062	-	-
2003	2006	Cadillac	Escalade ESV	Front	72-110038	72-120030	72-130030
2007	2014	Cadillac	Escalade ESV	Front	72-110001	-	72-130001
2016	2020	Cadillac	Escalade ESV	Front	72-110062	-	-
2002	2006	Cadillac	Escalade EXT	Front	72-110038	72-120030	72-130030
2007	2014	Cadillac	Escalade EXT	Front	72-110001	-	72-130001
2002	2006	Chevrolet	Avalanche ¹	Front	72-110030	72-120030	72-130030
2007	2010	Chevrolet	Avalanche	Front	72-110001	-	72-130001
2016	2022	Chevrolet	Colorado	Front	72-110074	-	-
1999	2006	Chevrolet	Silverado (Excl. New Body Style)(Excl. Chassis Cab) ¹	Front	72-110030	72-120030	72-130030
2007	2010	Chevrolet	Silverado (Excl. Classic)(Excl. Chassis Cab)	Front	72-110001	-	72-130001
2014	2016	Chevrolet	Silverado 1500 (Excl. Chassis Cab) ¹	Front	72-110062	-	-
2007	2007	Chevrolet	Silverado 1500 "Classic" (Excl. New Body Style)(Excl. Chassis Cab) ¹	Front	72-110038	72-120030	72-130030
1999	2006	Chevrolet	Silverado 2500/3500HD (Excl. New Body Style)(Excl. Chassis Cab) ¹	Front	72-110030	72-120030	72-130030
2016	2019	Chevrolet	Silverado 2500/3500	Front	72-110062	-	-
2019	2019	Chevrolet	Silverado LD (Excl. Chassis Cab) ¹	Front	72-110062	-	-
2019	2019	Chevrolet	Silverado LD Double Cab (Excl. Chassis Cab) ¹	Front	72-110062	-	-
2000	2006	Chevrolet	Suburban	Front	72-110030	72-120030	72-130030
2007	2014	Chevrolet	Suburban	Front	72-110001	-	72-130001
2016	2020	Chevrolet	Suburban	Front	72-110062	-	-
2000	2006	Chevrolet	Tahoe	Front	72-110030	72-120030	72-130030
2007	2014	Chevrolet	Tahoe	Front	72-110001	-	72-130001
2016	2020	Chevrolet	Tahoe	Front	72-110062	-	-
2010	2016	Chrysler	Town & Country	Front	-	-	72-130090
2013	2021	Dodge	Durango	Front	72-110094	-	-
2012	2020	Dodge	Grand Caravan	Front	-	-	72-130090
2012	2012	Dodge	Ram 1500 Classic Crew Cab ¹	Front	72-110043	-	-
2016	2022	Dodge	Ram 1500 Classic Crew Cab	Front	72-110043	-	-
2016	2022	Dodge	Ram 1500 Classic Mega Cab	Front	72-110043	-	-
2016	2022	Dodge	Ram 1500 Classic Quad Cab ¹	Front	72-110042	-	-
2016	2022	Dodge	Ram 1500 Classic Reg Cab ¹	Front	72-110042	-	-
2009	2018	Dodge	Ram 1500 Crew Cab	Front	72-110043	-	-
2016	2018	Dodge	Ram 1500 Mega Cab	Front	72-110043	-	-
2012	2018	Dodge	Ram 1500 Reg Cab	Front	72-110042	-	-
2016	2019	Dodge	Ram 1500 Reg Cab ¹	Front	72-110042	-	-
2012	2012	Dodge	Ram 2500/3500 Classic Crew Cab ¹	Front	72-110043	-	-
2010	2019	Dodge	Ram 2500/3500 Crew Cab	Front	72-110043	-	-

CONTINUED ON NEXT PAGE →

SURE FIT FLOOR LINERS/FRONT ROW CONTINUED

MOLDED RUBBERIZED COPOLYMER

START	END	MAKE	MODEL	POSITION	BLACK	GRAY	TAN
2010	2019	Dodge	Ram 2500/3500 Mega Cab	Front	72-110043	-	-
2012	2019	Dodge	Ram 2500/3500 Quad Cab	Front	72-110042	-	-
2010	2019	Dodge	Ram 2500/3500 Reg Cab ¹	Front	72-110042	-	-
2012	2019	Dodge	Ram 2500/3500 Reg Cab	Front	72-110042	-	-
2002	2008	Dodge	Ram 4WD (ALL)	Front	72-110027	-	-
2009	2018	Dodge	Ram Quad Cab	Front	72-110042	-	-
2015	2018	Ford	C-Max	Front	72-110066	-	-
2004	2008	Ford	F-150 (Excl. 2004 Heritage)	Front	72-110011	-	-
2009	2012	Ford	F-150 ¹⁰	Front	72-110018	-	-
2015	2020	Ford	F-150	Front	72-110069	-	-
2015	2020	Ford	F-150 Reg	Front	72-110069	-	-
2015	2023	Ford	F-150 SuperCab	Front	72-110069	-	-
2015	2023	Ford	F-150 SuperCrew	Front	72-110069	-	-
1999	2007	Ford	F-250/350/450/550 ¹	Front	72-110021	-	72-130021
2009	2010	Ford	F-250/350/450/550 ¹	Front	72-110018	-	-
2012	2016	Ford	F-250/350/450/550 ¹	Front	72-110039	-	-
2017	2023	Ford	F-250/350/450/550	Front	72-110084	-	-
2013	2019	Ford	Escape	Front	72-110069	-	-
2015	2022	GMC	Canyon Ext/Crew Cab	Front	72-110074	-	-
2007	2007	GMC	Sierra "Classic" (Excl. New Body Style) ^{1,11}	Front	72-110030	72-120030	72-130030
2014	2018	GMC	Sierra 1500	Front	72-110082	-	-
2019	2019	GMC	Sierra 1500 Limited Double Cab	Front	72-110082	-	-
1999	2006	GMC	Sierra 1500/2500LD (Excl. New Body Style) ^{1,11}	Front	72-110030	72-120030	72-130030
2007	2014	GMC	Sierra 2500/3500HD ¹	Front	72-110001	-	72-130001
2015	2019	GMC	Sierra 2500/3500	Front	72-110082	-	-
2000	2006	GMC	Yukon XL/Yukon Denali XL	Front	72-110030	72-120030	72-130030
2007	2014	GMC	Yukon XL/Yukon Denali XL	Front	72-110001	-	72-130001
2015	2020	GMC	Yukon XL/Yukon Denali XL	Front	72-110082	-	-
2008	2012	Honda	Accord Sedan/Coupe (Excl. Crosstour)	Front	72-110031	-	-
2020	2022	Jeep	Gladator	Front	72-110102	-	-
2015	2021	Jeep	Grand Cherokee	Front	72-110084	-	-
2016	2022	Jeep	Wrangler JL/Wrangler JL Unlimited	Front	72-110102	-	-
2012	2012	Ram	1500 Classic Crew Cab ¹⁰	Front	72-110043	-	-
2019	2022	Ram	1500 Classic Crew Cab	Front	72-110043	-	-
2019	2022	Ram	1500 Classic Mega Cab	Front	72-110043	-	-
2019	2022	Ram	1500 Classic Quad Cab ¹⁰	Front	72-110042	-	-
2019	2022	Ram	1500 Classic Reg Cab ¹⁰	Front	72-110042	-	-
2013	2018	Ram	1500 Crew Cab	Front	72-110043	-	-
2013	2018	Ram	1500 Mega Cab	Front	72-110043	-	-
2015	2018	Ram	1500 Quad Cab	Front	72-110042	-	-
2012	2018	Ram	1500 Reg Cab	Front	72-110042	-	-
2019	2022	Ram	1500 Reg Cab ¹	Front	72-110042	-	-
2012	2012	Ram	2500/3500 Classic Crew Cab ¹⁰	Front	72-110043	-	-
2010	2019	Ram	2500/3500 Crew Cab	Front	72-110043	-	-
2010	2019	Ram	2500/3500 Mega Cab	Front	72-110043	-	-
2012	2019	Ram	2500/3500 Quad Cab	Front	72-110042	-	-
2010	2019	Ram	2500/3500 Reg Cab ¹⁰	Front	72-110042	-	-
2012	2019	Ram	2500/3500 Reg Cab	Front	72-110042	-	-
2015	2018	Toyota	Rain	Front	72-110096	-	-
2003	2011	Toyota	Sequoia	Front	72-110015	-	-
2008	2011	Toyota	Tacoma ⁴	Front	72-110032	-	-
2016	2021	Toyota	Tacoma	Front	72-110079	-	72-130079
2016	2022	Toyota	Tacoma Double Cab	Front	72-110079	-	72-130079
2007	2021	Toyota	Tundra	Front	72-110015	-	-
2007	2021	Toyota	Tundra Reg Cab	Front	72-110015	-	-
2012	2014	Volkswagen	Routan	Front	-	-	72-130090

FOOTNOTES: Sure-Fit Floor Mats are designed for vehicles with carpeted floors. Will not fit vehicles with vinyl floors. 1. Fits With Bucket Seats. 2. Excludes Chassis Cab With Diesel Exhaust Fluid (DEF) Tank. Vehicles. 3. Excludes Vehicles With 4X4 Manual Transfer Case. 7. Fits Vehicles With Bench Seats Only. 8. Fits Vehicles Without Passenger Side Retention Hooks. 10. Fits Behind Third Seat. 12. Requires Minor Trimming For Models With "Executive Console" Package. 13. Fits Vehicles With Driver Left Side Foot Pad/Dead Pedal Only. 14. Fits Vehicles With Two Front Floor Retention Hooks. 16. Requires Trimming To Use With OEM Subwoofer. 18. Two Piece Set. 19 Mat Must Rest On Shelf Created By Battery Pack For Hybrid Vehicles Only. 20. Fits Vehicles With Vinyl Floor. 21. Fits Vehicles With Rear Seat Cargo Organizer. 22. Excludes Vehicles With Driver Left Side Foot Pad/Dead Pedal. 23. Fits Vehicles With One Retention Hook.

SURE FIT FLOOR LINERS/2ND ROW

MOLDED RUBBERIZED COPOLYMER

- » Custom fit for specific applications
- » Full coverage designs
- » Application specific
- » Available for most trucks and SUVs

FINISH: Black, Gray or Tan
 MATERIAL: Molded Rubberized Copolymer
 WARRANTY: Limited Lifetime



START	END	MAKE	MODEL	POSITION	BLACK	GRAY	TAN
2015	2020	Cadillac	Escalade	2nd Row	72-114064	-	-
2015	2020	Cadillac	Escalade ESV	2nd Row	72-114064	-	-
2015	2022	Chevrolet	Colorado Crew Cab	2nd Row	72-113075	-	-
2007	2007	Chevrolet	Silverado 1500 Classic Crew Cab	2nd Row	72-113031	-	-
2001	2006	Chevrolet	Silverado 1500 Crew Cab	2nd Row	72-113031	-	-
2007	2013	Chevrolet	Silverado 1500 Crew Cab (Excl. Classic)	2nd Row	72-114007	-	-
2001	2005	Chevrolet	Silverado 2500/3500 Crew Cab	2nd Row	72-113031	-	-
2007	2014	Chevrolet	Silverado 2500/3500 Crew Cab	2nd Row	72-114007	-	-
2015	2020	Chevrolet	Suburban	2nd Row	72-114064	-	-
2015	2020	Chevrolet	Tahoe (Bench and Bucket Seats)	2nd Row	72-114064	-	-
2011	2022	Dodge	Durango ¹	2nd Row	72-113095	-	-
2013	2021	Dodge	Durango ²	2nd Row	-	-	-
2019	2022	Dodge	Ram 1500 Classic Crew Cab	2nd Row	72-114026	-	-
2019	2022	Dodge	Ram 1500 Classic Quad Cab ³	2nd Row	72-114025	-	-
2009	2018	Dodge	Ram 1500 Crew Cab	2nd Row	72-114026	-	-
2009	2018	Dodge	Ram 1500 Quad Cab ³	2nd Row	72-114025	-	-
2010	2022	Dodge	Ram 2500/3500 Crew Cab	2nd Row	72-114026	-	-
2010	2018	Dodge	Ram 2500/3500 Quad Cab	2nd Row	72-114025	-	-
2013	2019	Ford	Escape	2nd Row	72-113060	-	-
2004	2008	Ford	F-150 SuperCab	2nd Row	72-114012	-	-
2009	2014	Ford	F-150 SuperCab	2nd Row	72-114019	-	-
2015	2020	Ford	F-150 SuperCab ^{4,5}	2nd Row	72-114071	-	-
2009	2014	Ford	F-150 SuperCrew	2nd Row	72-114020	-	-
2015	2020	Ford	F-150 SuperCrew ^{6,7}	2nd Row	72-114070	72-124070	-
1999	2007	Ford	F-250/350/450/550 Crew Cab	2nd Row	72-113014	-	-
2009	2018	Ford	F-250/350/450/550 Crew Cab	2nd Row	72-113014	-	-
2011	2018	Ford	F-250/350/450/550 Crew Cab	2nd Row	72-112038	-	-
2017	2020	Ford	F-250/350/450/550 Crew Cab	2nd Row	72-113085	-	-
2017	2019	Ford	F-250/350/450/550 SuperCab ⁸	2nd Row	72-114071	-	-
2015	2022	GMC	Canyon Crew Cab	2nd Row	72-113075	-	-
2001	2010	GMC	Sierra 2500/3500 Crew Cab	2nd Row	72-113031	-	-
2007	2014	GMC	Sierra 2500/3500 Crew Cab	2nd Row	72-114007	-	-
2015	2020	GMC	Yukon/Yukon Denali ⁹	2nd Row	72-114064	-	-
2015	2020	GMC	Yukon XL/Yukon XL Denali ¹⁰	2nd Row	72-114064	-	-
2011	2022	Jeep	Grand Cherokee	2nd Row	72-113095	-	-
2016	2020	Nissan	Titan ¹¹	2nd Row	72-113100	-	-
2015	2022	Nissan	Titan XD ¹²	2nd Row	72-113100	-	-
2019	2022	Ram	1500 Classic Crew Cab	2nd Row	72-114026	-	-
2019	2022	Ram	1500 Classic Quad Cab ¹³	2nd Row	72-114025	-	-
2009	2018	Ram	1500 Crew Cab	2nd Row	72-114026	-	-
2009	2018	Ram	1500 Quad Cab ¹⁴	2nd Row	72-114025	-	-
2010	2022	Ram	2500/3500 Crew Cab	2nd Row	72-114026	-	-
2010	2018	Ram	2500/3500 Quad Cab	2nd Row	72-114025	-	-
2005	2022	Toyota	Tacoma Double Cab	2nd Row	72-113073	-	-
2007	2021	Toyota	Tundra Double Cab	2nd Row	72-113016	72-123016	72-123016

FOOTNOTES: Sure-Fit Floor Mats are designed for vehicles with carpeted floors. Will not fit vehicles with vinyl floors. 1. Fits With Bucket Seats. 2. Excludes Chassis Cab With Diesel Exhaust Fluid (DEF) Tank Vehicles. 3. Excludes Vehicles With 4X4 Manual Transfer Case. 4. Fits Vehicles With Bench Seats Only. 5. Fits Vehicles Without Passenger Side Retention Hooks. 6. Fits Behind Third Seat. 7. Requires Minor Trimming For Models With "Executive Console" Package. 8. Fits Vehicles With Driver Left Side Foot Pad/Dead Pedal Only. 9. Fits Vehicles With Two Front Floor Retention Hooks. 10. Requires Trimming To Use With OEM Subwoofer. 11. Two Piece Set. 12. Mat Must Rest On Shelf Created By Battery Pack For Hybrid Vehicles Only. 13. Fits Vehicles With Vinyl Floor. 14. Fits Vehicles With Rear Seat Cargo Organizer. 22. Excludes Vehicles With Driver Left Side Foot Pad/Dead Pedal. 23. Fits Vehicles With One Retention Hook. 200. Not Compatible With Rear Underseat Cargo Box.

SURE FIT CARGO LINERS

MOLDED RUBBERIZED COPOLYMER

- » Custom fit for specific applications
- » Full coverage designs
- » Application specific
- » Available for most trucks and SUVs

FINISH: Black

MATERIAL: Molded Rubberized Copolymer

WARRANTY: Limited Lifetime



SURE FIT FLOOR LINERS/CARGO LINER

START	END	MAKE	MODEL	POSITION	BLACK	GRAY
2016	2020	Cadillac	Escalade ESV ¹⁴	Cargo	72-117065	72-127065
2016	2020	Chevrolet	Suburban ¹⁴	Cargo	72-117065	72-127065
2011	2018	Ford	Explorer ¹³	Cargo	72-117057	-
2016	2020	GMC	Yukon XL/Yukon Denali XL ¹⁴	Cargo	72-117065	72-127065
2011	2018	Jeep	Wrangler Unlimited 16 (Excl. 2016 JL)	Cargo	72-117060	-
2010	2019	Lincoln	MKT ¹⁴	Cargo	72-117057	-

FOOTNOTES: Sure-Fit Floor Mats are designed for vehicles with carpeted floors. Will not fit vehicles with vinyl floors. 1. Fits With Bucket Seats. 2. Excludes Chassis Cab With Diesel Exhaust Fluid (DEF) Tank Vehicles. 3. Excludes Vehicles With 4X4 Manual Transfer Case. 7. Fits Vehicles With Bench Seats Only. 8. Fits Vehicles Without Passenger Side Retention Hooks. 10. Fits Behind Third Seat. 12. Requires Minor Trimming For Models With "Executive Console" Package. 13. Fits Vehicles With Driver Left Side Foot Pad/Dead Pedal Only. 14. Fits Vehicles With Two Front Floor Retention Hooks. 16. Requires Trimming To Use With OEM Subwoofer. 18. Two Piece Set. 19. Mat Must Rest On Shelf Created By Battery Pack For Hybrid Vehicles Only. 20. Fits Vehicles With Vinyl Floor. 21. Fits Vehicles With Rear Seat Cargo Organizer. 22. Excludes Vehicles With Driver Left Side Foot Pad/Dead Pedal. 23. Fits Vehicles With One Retention Hook.



» Platinum Bug Shields 152



» Ultraguard Bug Shields 153



» Tape On Wind Deflectors 154



» In Channel Wind Deflectors 156



» Wind Guard Wind Deflectors 157



» Hood Scoops 158



» Cab Guard Wind Deflectors 158



PLATINUM BUG SHIELD

SMOKE OR CLEAR HIGH-IMPACT ACRYLIC

- » Helps protect paint and windshield from rock chips
- » Strong 1-piece construction
- » Manufactured from high-impact acrylic
- » Will not flex, flutter or vibrate at highway speeds
- » No drilling required on most applications

FINISH: Smoke and Clear

MATERIAL: High-Impact Acrylic

WARRANTY: Limited Lifetime



START	END	MAKE	MODEL	SMOKE	CLEAR	START	END	MAKE	MODEL	SMOKE	CLEAR
2007	2013	Chevrolet	Avalanche	72-91122	--	2001	2008	GMC	Sierra 2500/3500HD	72-98136	--
2002	2006	Chevrolet	Avalanche (w/ Body Cladding)	72-91104	--	2007	2013	GMC	Sierra 2500/3500HD	72-98140	--
2002	2006	Chevrolet	Avalanche (WO Body Cladding)	72-91114	--	1994	2005	GMC	Sonoma	72-91108	--
2004	2010	Chevrolet	Colorado	72-91116	--	2001	2008	GMC	Sonoma Crew Cab	72-91108	--
2015	2022	Chevrolet	Colorado	72-91136	--	2000	2008	GMC	Yukon/Yukon XL	72-98136	--
2005	2009	Chevrolet	Equinox	72-91118	--	2007	2014	GMC	Yukon/Yukon XL (Excl. Hybrid)	72-98144	--
1994	2005	Chevrolet	S-10	72-91103	--	2003	2003	Honda	Element	72-92104	--
1999	2005	Chevrolet	S-10 Blazer	72-91108	--	2006	2011	Honda	Ridgeline	72-92102	--
2000	2006	Chevrolet	Silverado 1500	72-91114	--	2000	2008	Isuzu	Ascender	72-90138	--
2014	2018	Chevrolet	Silverado 1500	72-91139	--	2005	2010	Jeep	Grand Cherokee	72-90146	--
2016	2018	Chevrolet	Silverado 1500	72-91138	--	1999	2004	Jeep	Grand Cherokee	72-90144	--
2019	2022	Chevrolet	Silverado 1500 (Excl. 2019-LD)	72-91149	--	2002	2007	Jeep	Liberty	72-90142	--
2005	2006	Chevrolet	Silverado 1500 "Classic"	72-91114	--	2018	2021	Jeep	Wrangler J.L. Unlimited 4Cr (Excl. 2018 JK)	72-90152	--
2007	2013	Chevrolet	Silverado 1500 Series (Excl. Hybrid/Excl. 2007 Classic)	72-91124	--	2007	2018	Jeep	Wrangler/Wrangler Unlimited (Excl. 2018 JL)	72-90150	--
1999	2002	Chevrolet	Silverado 1500 2500LD	72-91102	--	2005	2008	Lincoln	Mark LT	72-96122	--
2005	2007	Chevrolet	Silverado 2500/3500 "Classic"	72-91128	--	1997	2003	Mazda	B3000	72-96132	--
2001	2002	Chevrolet	Silverado 2500/3500HD	72-91102	--	1998	2003	Mazda	B3000 B4000	72-96132	--
2003	2004	Chevrolet	Silverado 2500/3500HD	72-91114	--	2008	2011	Mazda	Tribute	72-96146	--
2016	2019	Chevrolet	Silverado 2500/3500HD	72-91134	--	2005	2007	Mercury	Manner	72-96136	--
2019	2019	Chevrolet	Silverado LD	72-91138	--	2004	2016	Nissan	Armada	72-99130	--
2007	2014	Chevrolet	Suburban	72-91122	--	2001	2004	Nissan	Frontier	72-99134	--
2016	2020	Chevrolet	Suburban	72-91132	--	2005	2021	Nissan	Frontier	72-99128	--
2010	2002	Chevrolet	Suburban	72-91102	--	2005	2012	Nissan	Pathfinder	72-99126	--
2000	2002	Chevrolet	Tahoe	72-91102	--	2004	2016	Nissan	Titan	72-99130	--
2016	2020	Chevrolet	Tahoe	72-91132	--	2002	2004	Nissan	Xterra	72-99132	--
2007	2014	Chevrolet	Tahoe (Excl. Hybrid)	72-91122	--	2005	2016	Nissan	Xterra	72-99134	--
2002	2009	Chevrolet	Trafficazer	72-91106	--	2019	2022	Ram	1500 (Excl. Classic)	72-94140	--
2007	2010	Chrysler	Aspen	72-91114	--	2009	2018	Ram	1500	72-94134	--
2001	2007	Chrysler	Toan & Country	72-94122	--	2010	2021	Ram	2500/3500	72-94136	--
2001	2007	Dodge	Caravan	72-94122	--	2004	2007	Scion	Scion XB	72-97138	--
2004	2006	Dodge	Durango	72-94118	--	2006	2011	Suzuki	Grand Vitara	72-93102	--
2002	2006	Dodge	Ram (3-Place Seat)	72-94128	--	2003	2005	Toyota	4Runner	72-97156	--
2006	2008	Dodge	Ram 1500	72-94116	--	2001	2007	Toyota	Highlander	72-97192	--
2009	2018	Dodge	Ram 1500 (Excl. Rebel & Warlock)	72-94134	--	2001	2009	Toyota	RAV4	72-97154	--
2019	2021	Dodge	Ram 1500 Classic (Excl. Rebel & Warlock)	72-94134	--	2006	2012	Toyota	RAV4	72-97162	72-97164
2010	2018	Dodge	Ram 2500/3500	72-94138	--	2008	2019	Toyota	Sequoia	72-97164	--
2008	2014	Ford	Edge	72-96118	--	2001	2004	Toyota	Sequoia	72-97140	--
2001	2007	Ford	Escape	72-96136	--	2005	2011	Toyota	Tacoma	72-97160	--
2008	2012	Ford	Escape	72-96146	--	2012	2016	Toyota	Tacoma	72-97166	--
2008	2007	Ford	Escape Hybrid	72-96136	--	2016	2022	Toyota	Tacoma	72-97170	--
2010	2005	Ford	Excursion	72-96124	--	2001	2004	Toyota	Tacoma	72-97146	--
1997	2000	Ford	Expedition	72-96130	--	2007	2015	Toyota	Tundra	72-97164	--
2011	2016	Ford	Explorer	72-96152	--	2014	2021	Toyota	Tundra	72-97168	--
2002	2006	Ford	Explorer (Excl. 2002-2003 Sport Trac) (Excl. 2004-2005 Sport XLS/XLT)	72-96126	--	2000	2006	Toyota	Tundra	72-97140	--
2006	2010	Ford	Explorer Sport Trac	72-96140	--						
2004	2008	Ford	F-150	72-96122	--						
2009	2014	Ford	F-150	72-96148	--						
2016	2020	Ford	F-150	72-96154	--						
1997	2002	Ford	F-150 F-250 Light Duty	72-96130	--						
1999	2007	Ford	F-250/350/450/550 Super Duty	72-96124	--						
2011	2016	Ford	F-250/350/450/550 Super Duty	72-96150	--						
1998	2000	Ford	Ranger (Excl. Edge/XLT)	72-96132	--						
2004	2011	Ford	Ranger	72-96120	--						
2004	2012	GMC	Canyon	72-91116	--						
2001	2006	GMC	Denali Denali XL	72-90136	--						
1998	2006	GMC	Envoy	72-91100	--						
2002	2009	GMC	Envoy/Envoy XL	72-90138	--						
1995	2005	GMC	Jimmy (S-Series)	72-91108	--						
2007	2010	GMC	Sierra 1500 (Excl. Classic)	72-98140	--						
2014	2018	GMC	Sierra 1500	72-98148	--						
2007	2007	GMC	Sierra 1500 2500/3500 Classic	72-98136	--						
1999	2006	GMC	Sierra 1500/2500LD	72-98136	--						

FOOTNOTES: 1. Requires Drilling.

**ULTRAGUARD™ BUG SHIELD**
SMOKE OR CLEAR HIGH-IMPACT ACRYLIC

- » Full-wrap bug shield
- » Attractive design
- » Manufactured from high-impact acrylic
- » Bump-ons keep shield from touching hood
- » Made in the USA

FINISH: Smoke

MATERIAL: High-Impact Acrylic

WARRANTY: Limited Lifetime



START	END	MAKE	MODEL	SMOKE
1973	1980	Chevrolet	Blazer	72-31778
1992	1999	Chevrolet	Blazer ²	72-31782
1988	1998	Chevrolet	C/K Series Pickup (Excl. 1988-1991 Crew Cab) ²	72-31782
1973	1980	Chevrolet	Pickup	72-31778
1999	2002	Chevrolet	Silverado 1500/2500LD ²	72-31718
2001	2002	Chevrolet	Silverado 2500/3500HD ²	72-31718
1992	1999	Chevrolet	Suburban ²	72-31782
2000	2008	Chevrolet	Suburban ²	72-31718
1992	1999	Chevrolet	Tahoe ²	72-31782
2000	2008	Chevrolet	Tahoe ²	72-31718
1980	1995	Dodge	Ram Pickup	72-34772
1992	1996	Ford	Brooks ²	72-36708
1992	1996	Ford	F-150 ²	72-36708
1992	1998	Ford	F-250/350 (Excl. 1997-1998 F-350LD) ²	72-36708
1988	1998	GMC	C/K Pickup Full Size (Excl. 1988-1991 Crew Cab) ²	72-31782
2001	2008	GMC	Denali	72-31728
1973	1980	GMC	Jimmy	72-31778
1973	1980	GMC	Pickup Full Size	72-31778
1999	2002	GMC	Sierra 1500/2500LD ²	72-31728
2001	2002	GMC	Sierra 2500/3500HD ²	72-31728
2001	2007	GMC	Sierra HD "Classic" ²	72-31728
1973	1980	GMC	Suburban	72-31778
1992	1999	GMC	Suburban ²	72-31782
1992	1999	GMC	Yukon ²	72-31782
2000	2008	GMC	Yukon/Yukon XL ²	72-31728
1990	1995	Toyota	4Runner	72-87782
1998	2002	Toyota	4Runner ²	72-87782
1999	1999	Toyota	Pickup	72-87782
1993	1999	Toyota	T-100 ²	72-87718
1996	2000	Toyota	Tacoma ²	72-87782

FOOTNOTES: 2. No Drilling Required.



TAPE ON WIND DEFLECTORS

HIGH GLOSS SMOKE HIGH-IMPACT ACRYLIC

- » Attaches using automotive grade tape
- » Reduces heat and glare
- » Allows fresh air circulation during any weather condition
- » Made in the USA

FINISH: High Gloss Smoke
MATERIAL: High-Impact Acrylic
WARRANTY: Limited Lifetime



START	END	MAKE	MODEL	2-PIECE	4-PIECE
2004	2007	Buick	Rainier	—	72-39416
1999	2001	Cadillac	Escalade	—	72-39402
2002	2006	Cadillac	Escalade	—	72-39402
2007	2014	Cadillac	Escalade	—	72-39496
2002	2006	Cadillac	Escalade ESV/EXT	—	72-39496
1996	2005	Chevrolet	Astro Van	72-39462	—
2002	2005	Chevrolet	Avalanche	—	72-39496
2007	2013	Chevrolet	Avalanche	—	72-39408
1983	1994	Chevrolet	Blazer 5-10 2Dr	72-39462	—
1995	2005	Chevrolet	Blazer 5-10 2Dr	72-39470	—
1995	2005	Chevrolet	Blazer 5-10 4Dr 5-Series	—	72-39490
1992	1994	Chevrolet	Blazer (Full Size)	72-39468	—
1995	2005	Chevrolet	Cavalier 2Dr/2.4	72-39474	—
2005	2010	Chevrolet	Cobalt 2Dr	72-39476	—
2015	2022	Chevrolet	Colorado Crew Cab	—	72-31402
2004	2010	Chevrolet	Colorado Ext Cab	—	72-39488
2015	2022	Chevrolet	Colorado Ext Cab	72-39456	—
2004	2010	Chevrolet	Colorado Reg Cab	72-39466	—
2011	2015	Chevrolet	Cruze	—	72-31486
1998	2021	Chevrolet	Express van (Full Size)	72-39460	—
2002	2005	Chevrolet	Impala	—	72-39404
2003	2010	Chevrolet	Kodak Reg Cab	72-39460	—
2009	2012	Chevrolet	Malibu	—	72-39434
1992	2000	Chevrolet	Pickup Crew Cab	—	72-39492
1983	1999	Chevrolet	Pickup (Full Size) (Excl. 1988-1991 Crew Cab)	72-39468	—
1988	1999	Chevrolet	Pickup Ext Cab (Full Size)	—	72-39494
1982	1993	Chevrolet	S-10 Pickup	72-39462	—
1994	2005	Chevrolet	S-10 Pickup	72-39470	—
2007	2014	Chevrolet	Silverado 1500 Crew Cab (Excl. Classic)	—	72-39408
2014	2018	Chevrolet	Silverado 1500 Crew Cab	—	72-31484
2019	2022	Chevrolet	Silverado 1500 Crew Cab	—	72-31408
2014	2018	Chevrolet	Silverado 1500 Double Cab	—	72-31482
2019	2022	Chevrolet	Silverado 1500 Double Cab (Excl. 2019 LD)	—	72-31410
2007	2010	Chevrolet	Silverado 1500 Reg Cab	72-39464	—
2014	2018	Chevrolet	Silverado 1500 Reg Cab	72-39458	—
1999	2006	Chevrolet	Silverado 1500 2500LD	72-39472	—
2007	2006	Chevrolet	Silverado 1500 2500LD Crew Cab	—	72-39498
1999	2006	Chevrolet	Silverado 1500 2500LD Ext Cab	—	72-39496
2007	2014	Chevrolet	Silverado 2500 3500 Reg Cab	72-39464	—
2007	2014	Chevrolet	Silverado 2500 3500HD Crew Cab	—	72-39408
2015	2019	Chevrolet	Silverado 2500 3500HD Crew Cab	—	72-31484
2015	2019	Chevrolet	Silverado 2500 3500HD Double Cab	—	72-31482
2014	2014	Chevrolet	Silverado 2500 3500HD Ext Cab	—	72-39410
2015	2019	Chevrolet	Silverado 2500 3500HD Reg Cab	72-39458	—
2007	2013	Chevrolet	Silverado Ext Cab (Excl. Classic)	—	72-39410
2018	2019	Chevrolet	Silverado LD Double Cab	—	72-31482
1992	1999	Chevrolet	Suburban	—	72-39492
2009	2006	Chevrolet	Suburban	—	72-39498
2007	2014	Chevrolet	Suburban	—	72-39408
1995	1999	Chevrolet	Tahoe	72-39468	72-39492
2002	2006	Chevrolet	Tahoe	—	72-39402
2007	2014	Chevrolet	Tahoe	—	72-39406
2002	2009	Chevrolet	Traillazer LT (W/ 19" Window)	—	72-39416
2006	2009	Chevrolet	Traillazer SS	—	72-39416
2007	2010	Chrysler	Aspen	—	72-35490
2001	2010	Chrysler	PT Cruiser	—	72-35406
1995	2007	Chrysler	Toan & Country	72-35466	—
1996	2007	Dodge	Caravan	72-35466	—
2011	2022	Dodge	Charger	—	72-35428
1987	2004	Dodge	Dakota	72-35472	—
2005	2010	Dodge	Dakota Quad Cab	—	72-35488
1998	2008	Dodge	Durango	—	72-35416
2004	2010	Dodge	Durango	—	72-35490
2011	2022	Dodge	Durango	—	72-35430
1994	2002	Dodge	Ram (Excl. W/ Towing Mirror)	72-35466	—
2019	2022	Dodge	Ram 1500 Classic Crew Cab	—	72-35402
2019	2022	Dodge	Ram 1500 Classic Quad Cab	—	72-35404
2009	2018	Dodge	Ram 1500 Crew Cab	—	72-35402
2019	2022	Dodge	Ram 1500 Crew Cab (Excl. Classic)	—	72-35432
2006	2009	Dodge	Ram 1500 Mega Cab	—	72-35496
1998	2001	Dodge	Ram 1500 Quad Cab	72-35468	72-35492
2002	2008	Dodge	Ram 1500 Quad Cab	72-35470	72-35494
2009	2018	Dodge	Ram 1500 Quad Cab	—	72-35404
2019	2022	Dodge	Ram 1500 Quad Cab (Excl. Classic)	—	72-35434
2003	2008	Dodge	Ram 2500 3500	—	72-35494

START	END	MAKE	MODEL	2-PIECE	4-PIECE
2009	2022	Dodge	Ram 2500/3500 Crew Cab/Mega Cab	—	72-39402
1980	1998	Ford	Bronco	72-37488	—
1998	2011	Ford	Chariot Victoria (Excl. Landau Top)	—	72-37428
1992	2010	Ford	Econoline Van (Full Size)	72-37454	—
2001	2012	Ford	Escape	72-37464	72-37482
2015	2019	Ford	Escape	—	72-37442
1997	2017	Ford	Expedition	72-37462	72-37498
2018	2022	Ford	Expedition	—	72-37448
2007	2017	Ford	Expedition EL	72-37462	72-37498
1991	2001	Ford	Explorer 4Dr	—	72-37492
2002	2010	Ford	Explorer 4Dr	—	72-37486
2011	2019	Ford	Explorer 4Dr	—	72-37438
2001	2008	Ford	Explorer Sport Trac 4Dr	—	72-37492
2007	2010	Ford	Explorer Sport Trac 4Dr	—	72-37486
2009	2014	Ford	F-150 Reg Cab	72-37498	—
2015	2023	Ford	F-150 Reg Cab	72-37472	—
2004	2008	Ford	F-150 SuperCab (Excl. Heritage)	—	72-37408
2015	2023	Ford	F-150 SuperCab	—	72-37446
2001	2004	Ford	F-150 SuperCrew	—	72-37418
2004	2008	Ford	F-150 SuperCrew (Excl. Heritage)	—	72-37488
2009	2014	Ford	F-150 SuperCrew	—	72-37424
2015	2023	Ford	F-150 SuperCrew	—	72-37444
1980	1996	Ford	F-250 350 450 650	72-37466	—
1999	2018	Ford	F-250 350 450 650	72-37456	—
1999	2018	Ford	F-250 350 450 650 Crew Cab	—	72-37414
2017	2021	Ford	F-250 350 450 650 Crew Cab	—	72-37444
1999	2016	Ford	F-250 350 450 650 Ext Cab	—	72-37412
2017	2021	Ford	F-250 350 450 650 Reg Cab	72-37472	—
2017	2021	Ford	F-250 350 450 650 SuperCab	—	72-37446
1995	1998	Ford	F-350	72-37456	—
1997	2008	Ford	F-Series Ext Cab	72-37474	72-37498
1997	2004	Ford	F-Series Light Duty	72-37474	—
2008	2011	Ford	Focus 4Dr	—	72-37428
2012	2014	Ford	Focus 4Dr	—	72-37440
2008	2012	Ford	Fusion	—	72-37426
1993	2011	Ford	Ranger	72-37470	—
1999	2011	Ford	Ranger (W/ Fixed Rear Window)	—	72-37422
2001	2009	Ford	Ranger Edge	72-37470	—
2007	2016	GMC	Acadia	—	72-39448
2015	2022	GMC	Canyon Crew Cab	—	72-31402
2004	2012	GMC	Canyon Ext Cab	—	72-39488
2004	2010	GMC	Canyon Reg Cab	72-39466	—
2015	2022	GMC	Canyon Reg Ext Cab	72-39456	—
1999	2000	GMC	Denali	—	72-39492
2001	2006	GMC	Denali	—	72-39402
2001	2006	GMC	Denali XL	—	72-39498
2007	2009	GMC	Denali XL	—	72-39408
1998	2007	GMC	Envoy	—	72-39490
2002	2009	GMC	Envoy	—	72-39416
1993	1994	GMC	Jimmy, S-Series 2Dr	72-39462	—
1995	2005	GMC	Jimmy, S-Series 2Dr	72-39470	—
1995	2005	GMC	Jimmy, S-Series 4Dr	—	72-39490
1992	2000	GMC	Pickup, Crew Cab	—	72-39492
1988	1999	GMC	Pickup, (Full Size) (Excl. 1988-1991 Crew Cab)	72-39468	—
1994	2003	GMC	Pickup, Ext Cab (Full Size)	—	72-39494
1994	2003	GMC	Pickup, Sonoma	72-39470	—
1982	1993	GMC	S-15 Sonoma	72-39462	—
1995	2004	GMC	S-15 Pickup	72-39470	—
1995	2006	GMC	Safari Van	72-39462	—
1995	2001	GMC	Savana van (Full Size) (G)	72-39460	—
2007	2007	GMC	Sierra 1500 Classic Crew Cab	—	72-39498
2007	2007	GMC	Sierra 1500 Classic Ext Cab	—	72-39496
2014	2018	GMC	Sierra 1500 Crew Cab	—	72-31484
2019	2022	GMC	Sierra 1500 Crew Cab	—	72-31408
2014	2018	GMC	Sierra 1500 Double Cab	—	72-31482
2019	2022	GMC	Sierra 1500 Double Cab (Excl. 2019 Limited)	—	72-31410
2019	2019	GMC	Sierra 1500 Limited Double Cab	—	72-31482
2007	2013	GMC	Sierra 1500 Reg Cab (Excl. Classic)	72-39464	—
2014	2018	GMC	Sierra 1500 Reg Cab	72-39458	—
1999	2006	GMC	Sierra 1500 2500LD	72-39472	—
1999	2006	GMC	Sierra 1500 2500LD Crew Cab	—	72-39498
1999	2006	GMC	Sierra 1500 2500LD Ext Cab	—	72-39496
2015	2019	GMC	Sierra 2500 3500 Double Cab	—	72-31482
2007	2014	GMC	Sierra 2500 3500HD Crew Cab	—	72-39408
2015	2019	GMC	Sierra 2500 3500HD Crew Cab	—	72-31484

CONTINUED ON NEXT PAGE ➔



TAPE ON WIND DEFLECTORS *CONTINUED*

HIGH GLOSS SMOKE HIGH-IMPACT ACRYLIC

START	END	MAKE	MODEL	2-PIECE	4-PIECE	START	END	MAKE	MODEL	2-PIECE	4-PIECE
2007	2014	GMC	Sierra 2500/3500HD Ext Cab	—	T2-39410	1998	2001	Oldsmobile	Bravada	T2-39470	T2-39490
2007	2014	GMC	Sierra 2500/3500HD Reg Cab	T2-39464	—	2002	2004	Oldsmobile	Bravada	—	T2-39416
2015	2019	GMC	Sierra 2500/3500HD Reg Cab	T2-39458	—	1998	2004	Plymouth	Voyager	T2-39466	—
1992	2000	GMC	Suburban	T2-39468	T2-39492	2002	2006	Pontiac	Vibe	—	T2-39496
2003	2010	GMC	Topkick Reg Cab	T2-39460	—	2009	2010	Pontiac	Vibe	—	T2-39426
2007	2014	GMC	Yukon	—	T2-39496	1994	2002	Ram	1500 (Excl. W/ Towing Mirror)	T2-39468	—
1992	1999	GMC	Yukon 2DR	T2-39468	—	2019	2022	Ram	1500 Classic Crew Cab	—	T2-39402
1996	2000	GMC	Yukon 4DR	—	T2-39492	2019	2022	Ram	1500 Classic Quest Cab	—	T2-39404
2000	2006	GMC	Yukon/Yukon Denali 4DR	—	T2-39402	2009	2016	Ram	1500 Crew Cab	—	T2-39402
2000	2006	GMC	Yukon XL/Yukon Denali XL	—	T2-39498	2019	2022	Ram	1500 Crew Cab (Excl. Classic)	—	T2-39412
2007	2014	GMC	Yukon XL/Yukon Denali XL	—	T2-39408	2006	2009	Ram	1500 Mega Cab	—	T2-39496
2008	2011	Honda	Civic Sedan	—	T2-44488	1998	2002	Ram	1500 Quad Cab	T2-39468	T2-39492
2003	2008	Honda	Pilot	—	T2-44482	2003	2009	Ram	1500 Quad Cab	T2-39470	T2-39494
2017	2022	Honda	Ridgeline	—	T2-44480	2019	2018	Ram	1500 Quad Cab	—	T2-39404
2006	2010	Hummer	H3	—	T2-39414	2009	2012	Ram	1500 Quad Cab (Excl. Classic)	—	T2-39424
2001	2006	Hyundai	Santa Fe	—	T2-43484	2009	2009	Ram	1500 Reg Cab	T2-39470	—
2011	2014	Hyundai	Sonata	—	T2-43480	2009	2022	Ram	2500/3500 Crew Cab/Mega Cab	—	T2-39402
1997	2004	Infiniti	QX4	—	T2-69490	2003	2009	Ram	2500/3500 Quad Cab	—	T2-39494
2004	2010	Infiniti	QX55	—	T2-69496	2005	2009	SAAB	9-7X	—	T2-39416
2004	2008	Isuzu	Ascender (3 Passenger)	—	T2-39416	2009	2012	Subaru	Forester	—	T2-32482
2006	2010	Isuzu	i300	T2-39466	—	2008	2011	Subaru	Impreza	—	T2-32480
1996	2001	Isuzu	Pickup, Hombre	T2-39470	—	2010	2012	Subaru	Legacy	—	T2-32486
1984	2001	Jeep	Cherokee	—	T2-51498	2010	2012	Subaru	Outback	—	T2-32488
2014	2021	Jeep	Cherokee	—	T2-51488	2006	2011	Suzuki	Grand Vitara	—	T2-36434
1993	1999	Jeep	Grand Cherokee	T2-51464	T2-51402	2001	2006	Suzuki	Grand Vitara XL7	—	T2-36432
1999	2004	Jeep	Grand Cherokee	T2-51462	T2-51492	2007	2009	Suzuki	XL7	—	T2-36436
2005	2010	Jeep	Grand Cherokee	—	T2-51494	1996	2002	Toyota	4Runner	T2-39464	T2-39490
2011	2021	Jeep	Grand Cherokee	—	T2-51490	2003	2009	Toyota	4Runner	—	T2-39498
1997	2006	Jeep	Wrangler	T2-51460	—	2010	2019	Toyota	4Runner	—	T2-39430
2018	2022	Jeep	Wrangler JL (Excl. 2018 JK)	T2-51468	—	2007	2011	Toyota	Camry	—	T2-39414
2018	2022	Jeep	Wrangler JL Unlimited 4Dr (Excl. 2018 JK)	—	T2-51404	2016	2017	Toyota	Camry	—	T2-39454
2007	2018	Jeep	Wrangler/Unlimited (Excl. JL 2018)	—	T2-51496	2009	2013	Toyota	Corolla	—	T2-39424
2003	2009	Kia	Sorento	—	T2-55486	2014	2019	Toyota	Corolla	—	T2-39448
2002	2005	Lincoln	Avalon	—	T2-37486	1998	2002	Toyota	Corolla 4Dr	—	T2-39438
2002	2003	Lincoln	Blackwood	—	T2-37410	2003	2006	Toyota	Corolla Sedan	—	T2-39406
2006	2009	Lincoln	Mark LT	—	T2-37488	2014	2019	Toyota	Highlander	—	T2-39452
1998	2010	Lincoln	Navigator	T2-37462	T2-37498	2001	2007	Toyota	HighlanderHybrid	—	T2-39484
1998	2010	Lincoln	Town Car	—	T2-37416	2008	2013	Toyota	HighlanderHybrid	—	T2-39428
2004	2009	Mazda	3 Sedan	—	T2-57484	2003	2006	Toyota	Matrix	—	T2-39436
2004	2009	Mazda	3 Wagon (Hatchback)	—	T2-57486	2009	2015	Toyota	Matrix	—	T2-39426
2004	2009	Mazda	3 Wagon (Hatchback)	—	T2-57486	2001	2006	Toyota	RAV4	—	T2-39438
1994	2006	Mazda	B-Series Pickup	T2-37470	—	2006	2012	Toyota	RAV4	—	T2-39412
1998	2011	Mercury	Grand Marquis (Excl. Landau)	—	T2-37420	2001	2007	Toyota	Sequoia	—	T2-39496
2001	2011	Mercury	Mariner	T2-37464	T2-37482	2004	2010	Toyota	Sienna	—	T2-39430
1997	2001	Mercury	Mountaineer	—	T2-37492	1996	2004	Toyota	Tacoma	T2-39472	—
2002	2011	Mercury	Mountaineer	—	T2-37486	2005	2022	Toyota	Tacoma Double Cab	—	T2-39410
2005	2009	Mitsubishi	Raider	—	T2-35488	1996	2004	Toyota	Tacoma Ext Cab	—	T2-39432
2007	2010	Nissan	Altima 4DR (Alt)	—	T2-69494	2005	2022	Toyota	Tacoma Reg-Access Cab	T2-39458	—
2004	2016	Nissan	Armada	—	T2-69496	2000	2006	Toyota	Tundra	T2-39476	—
2017	2022	Nissan	Armada	—	T2-69420	2007	2021	Toyota	Tundra CrewMax	—	T2-39420
1998	2004	Nissan	Frontier	T2-69462	—	2000	2006	Toyota	Tundra Double Cab	T2-39476	T2-39494
2000	2004	Nissan	Frontier Crew Cab	—	T2-69492	2004	2006	Toyota	Tundra Double Cab	—	T2-39422
2005	2021	Nissan	Frontier Crew Cab	—	T2-69484	2007	2021	Toyota	Tundra Double Cab	—	T2-39418
2005	2021	Nissan	Frontier King Cab 2DR	T2-69466	—	2007	2021	Toyota	Tundra CrewMax	—	T2-39420
2003	2007	Nissan	Murano	—	T2-69494	2000	2006	Toyota	Tundra Double Cab	T2-39476	T2-39494
1996	2004	Nissan	Pathfinder	—	T2-69490	2004	2006	Toyota	Tundra Double Cab	—	T2-39422
2005	2012	Nissan	Pathfinder	—	T2-69486	2007	2021	Toyota	Tundra Double Cab	—	T2-39418
2015	2019	Nissan	Pathfinder	—	T2-69478						
1986 S	1990	Nissan	Pathfinder 2DR	T2-69464	—						
1986 S	1997	Nissan	Pickup 2DR	T2-69464	—						
2004	2015	Nissan	Titan Crew Cab	—	T2-69402						
2004	2015	Nissan	Titan King Cab	T2-69458	—						
2007	2011	Nissan	Versa Sedan 4DR	—	T2-69414						
2000	2004	Nissan	Xterra	—	T2-69488						
2005	2016	Nissan	Xterra	—	T2-69482						

FOOTNOTES: 1. May Need To Reset Automatic Windows.



IN CHANNEL WIND DEFLECTORS

HIGH GLOSS SMOKE HIGH-IMPACT ACRYLIC

- » Slips directly into the window channel
- » Installs quickly and easily without exterior tape
- » Secured using automotive grade tape
- » Allows fresh air circulation in any weather

FINISH: High Gloss Smoke
MATERIAL: High-Impact Acrylic
WARRANTY: Limited Lifetime



START	END	MAKE	MODEL	2-PIECE	4-PIECE	START	END	MAKE	MODEL	2-PIECE	4-PIECE
2004	2007	Buick	Rainier	—	72-39487	2004	2008	Ford	F-150 SuperCrew (Excl. Heritage)	—	72-37488
1999	2001	Cadillac	Escalade	—	72-39491	2009	2014	Ford	F-150 SuperCrew	—	72-37409
2002	2006	Cadillac	Escalade	—	72-39493	2015	2020	Ford	F-150 SuperCrew	—	72-37407
2016	2020	Cadillac	Escalade	—	72-39419	1997	2004	Ford	F-150 F-250/D	72-37473	—
2016	2020	Cadillac	Escalade ESV	—	72-39421	1999	2016	Ford	F-250/350/450/500 Super Duty Crew Cab	72-37475	72-37479
2002	2006	Cadillac	Escalade ESV EXT	—	72-39497	2017	2023	Ford	F-250/350/450/500 Super Duty Crew Cab	—	72-37407
2007	2014	Cadillac	Escalade ESV EXT	—	72-39411	2017	2023	Ford	F-250/350/450/500 Super Duty SuperCab	—	72-37409
2002	2006	Chevrolet	Avalanche	—	72-39497	2004	2007	Ford	Freestyle	—	72-37401
2007	2013	Chevrolet	Avalanche	—	72-39405	2001	2011	Ford	Ranger Edge	72-37469	—
1992	1999	Chevrolet	C/K Pickup Crew Cab	72-39467	72-39491	2003	2009	Ford	Taurus X	—	72-37401
1983	1993	Chevrolet	C/K Pickup (Excl. 1983-1991 Crew Cab)	72-39467	—	2010	2019	Ford	Escape	—	72-37419
2004	2012	Chevrolet	Colorado Crew Cab	—	72-39428	2004	2012	GMC	Canyon Crew Cab	—	72-39489
2016	2022	Chevrolet	Colorado Crew Cab	—	72-39423	2016	2022	GMC	Canyon Crew Cab	—	72-39423
2016	2022	Chevrolet	Colorado Ext Cab	72-39477	—	2016	2022	GMC	Canyon Ext Cab	72-39477	—
2004	2012	Chevrolet	Colorado Reg Cab	72-39466	—	2004	2012	GMC	Canyon Reg Cab	72-39466	—
2006	2009	Chevrolet	Equinox	—	72-39401	1999	2001	GMC	Envoy	—	72-39409
1996	2005	Chevrolet	8-10 Blazer	72-39469	72-39409	2002	2008	GMC	Envoy LT (w/ 19" Rear Window)	—	72-39407
1994	2005	Chevrolet	8-10 Pickup	72-39469	—	2002	2009	GMC	Envoy/Envoy Denali	—	72-39407
2007	2013	Chevrolet	Silverado 1500 Crew Cab (Excl. Classic)	—	72-39406	1996	2001	GMC	Jimmy	72-39469	72-39409
2014	2018	Chevrolet	Silverado 1500 Crew Cab	—	72-39416	1999	2006	GMC	Sierra 1500 Crew Cab	72-39471	72-39497
2019	2022	Chevrolet	Silverado 1500 Crew Cab	—	72-39429	2007	2013	GMC	Sierra 1500 Crew Cab (Excl. Classic)	—	72-39406
2014	2018	Chevrolet	Silverado 1500 Double Cab	—	72-39417	2014	2018	GMC	Sierra 1500 Crew Cab	—	72-39416
2007	2013	Chevrolet	Silverado 1500 Ext Cab (Excl. Classic)	—	72-39407	2019	2022	GMC	Sierra 1500 Crew Cab	—	72-39429
2007	2013	Chevrolet	Silverado 1500 Reg Cab (Excl. Classic)	72-39473	—	2014	2018	GMC	Sierra 1500 Double Cab	—	72-39417
1999	2007	Chevrolet	Silverado 1500 2500LD Crew Cab	—	72-39497	2007	2013	GMC	Sierra 1500 Ext Cab (Excl. Classic)	—	72-39407
1999	2007	Chevrolet	Silverado 1500 2500LD Reg Cab	72-39471	—	2019	2019	GMC	Sierra 1500 Limited Double Cab	—	72-39417
2007	2014	Chevrolet	Silverado 2500 3500HD Crew Cab	—	72-39405	2007	2013	GMC	Sierra 1500 Reg Cab (Excl. Classic)	72-39473	—
2016	2019	Chevrolet	Silverado 2500 3500HD Crew Cab	—	72-39416	2001	2006	GMC	Sierra 2500 3500HD Crew Cab	72-39471	72-39497
2016	2019	Chevrolet	Silverado 2500 3500HD Double Cab	—	72-39417	2007	2014	GMC	Sierra 2500 3500HD Crew Cab	—	72-39406
2007	2014	Chevrolet	Silverado 2500 3500HD Ext Cab	—	72-39407	2016	2019	GMC	Sierra 2500 3500HD Crew Cab	—	72-39416
2007	2014	Chevrolet	Silverado 2500 3500HD Reg Cab	72-39473	—	2016	2019	GMC	Sierra 2500 3500HD Double Cab	—	72-39417
2019	2019	Chevrolet	Silverado LD Double Cab	—	72-39417	2007	2016	GMC	Sierra 2500 3500HD Ext Cab	—	72-39407
1992	1999	Chevrolet	Suburban	72-39467	72-39491	2007	2016	GMC	Sierra 3500 3500HD Reg Cab	72-39473	—
2016	2020	Chevrolet	Suburban	—	72-39421	1994	2004	GMC	Sonoma	72-39469	—
2000	2006	Chevrolet	Suburban	72-39471	72-39497	1992	1999	GMC	Yukon	72-39467	—
2007	2014	Chevrolet	Suburban	—	72-39406	2000	2006	GMC	Yukon/Yukon Denali	—	72-39496
1992	1999	Chevrolet	Tahoe	72-39467	72-39491	2007	2014	GMC	Yukon/Yukon Denali	—	72-39403
2016	2020	Chevrolet	Tahoe	—	72-39418	2016	2020	GMC	Yukon/Yukon Denali	—	72-39419
2000	2006	Chevrolet	Tahoe	—	72-39496	2007	2014	GMC	Yukon XL/Yukon Denali XL	—	72-39406
2007	2014	Chevrolet	Tahoe	—	72-39403	2016	2020	GMC	Yukon XL/Yukon Denali XL	—	72-39421
2002	2009	Chevrolet	Traillazer LT (w/ 19" Rear Window)	—	72-39487	2005	2007	Honda	Accord	—	72-44481
2006	2009	Chevrolet	Traillazer SS	—	72-39487	2010	2019	Honda	Accord Sedan	—	72-44491
2007	2009	Chrysler	Aspen	—	72-35491	2016	2019	Honda	Civic Sedan	—	72-44493
2011	2020	Dodge	Charger	—	72-35406	2003	2010	Honda	Element	72-44485	—
1997	2004	Dodge	Dakota	72-35471	—	2006	2012	Honda	Ridgeline	—	72-44483
2006	2010	Dodge	Dakota	72-35473	72-39489	2017	2022	Honda	Ridgeline	—	72-44419
2000	2004	Dodge	Dakota Quad Cab	—	72-35497	2000	2010	Hummer	Hummer H2	—	72-39493
1998	2003	Dodge	Durango	—	72-35496	2017	2019	Hyundai	Elantra	—	72-41419
2004	2010	Dodge	Durango	—	72-35491	2004	2010	Infiniti	QX56	—	72-69493
2019	2022	Dodge	Ram 1500 Classic Crew Cab	—	72-39401	2004	2009	Isuzu	Ascender (5 Passenger)	—	72-39487
2019	2022	Dodge	Ram 1500 Classic Quad Cab	—	72-35403	2006	2010	Isuzu	i300	72-39466	—
2009	2018	Dodge	Ram 1500 Crew Cab	—	72-39401	2006	2011	Isuzu	G50 D-Max Double Cab	—	72-39486
2019	2022	Dodge	Ram 1500 Crew Cab (Excl. Classic)	—	72-35407	2014	2021	Jeep	Cherokee	—	72-51487
2008	2009	Dodge	Ram 1500 Mega Cab	—	72-35499	2020	2022	Jeep	Gladiator	—	72-51499
2002	2008	Dodge	Ram 1500 Quad Cab	72-35469	72-35493	1999	2004	Jeep	Grand Cherokee	—	72-51491
2009	2016	Dodge	Ram 1500 Quad Cab	—	72-35403	2006	2010	Jeep	Grand Cherokee	—	72-51489
2019	2022	Dodge	Ram 1500 Quad Cab (Excl. Classic)	—	72-35409	2011	2021	Jeep	Grand Cherokee	—	72-51487
1994	2002	Dodge	Ram 1500 Reg Cab	72-39467	—	2002	2007	Jeep	Liberty	72-51463	72-51493
2002	2008	Dodge	Ram 1500 Reg Cab	72-35466	—	2007	2010	Jeep	Wrangler JK 4DR	72-51465	—
2010	2022	Dodge	Ram 2500 3500 Crew Cab/Mega Cab	—	72-39401	2007	2013	Jeep	Wrangler JK Unlimited 4DR	—	72-51499
2010	2022	Dodge	Ram 2500 3500 Quad Cab	—	72-35403	2010	2022	Jeep	Wrangler JL 4DR	72-51467	—
2003	2009	Dodge	Ram 2500 3500 Reg Cab	72-39466	—	2010	2022	Jeep	Wrangler JL Unlimited 4DR	—	72-51499
1992	2011	Ford	Crown Victoria (Excl. Landau Top)	—	72-37487	2003	2008	Lincoln	Avalon	—	72-37493
2001	2007	Ford	Escape	—	72-37496	2002	2005	Lincoln	Blackwood	—	72-37496
2003	2012	Ford	Escape	—	72-37403	2008	2008	Lincoln	Mark LT Pickup	—	72-37488
2000	2005	Ford	Expedition	—	72-37483	1996	2006	Lincoln	Navigator	—	72-37497
1997	2017	Ford	Expedition	—	72-37497	1994	2009	Mazda	Pickup, Single Cab	72-37469	—
2016	2022	Ford	Expedition F	—	72-37417	1992	2010	Mercury	Grand Marquis	—	72-37407
2002	2010	Ford	Explorer 4DR	—	72-37493	2006	2007	Mercury	Mariner	—	72-37496
2007	2010	Ford	Explorer Sport Trac	—	72-37490	2003	2009	Mercury	Vanisher	—	72-37403
2004	2008	Ford	F-150 Reg Cab	72-37463	—	2002	2010	Mercury	Mountaineer	—	72-37493
2004	2014	Ford	F-150 SuperCab (Excl. Heritage)	—	72-37481	2004	2010	Mitsubishi	Endeavor	—	72-66481
2015	2023	Ford	F-150 SuperCab	—	72-37409	2016	2020	Mitsubishi	Outlander	—	72-66483
2004	2014	Ford	F-150 SuperCab (Work Truck)(Excl. Heritage)	72-37463	—	2005	2009	Mitsubishi	Raider	72-35473	72-35489
2001	2004	Ford	F-150 SuperCrew	—	72-37499	2004	2016	Nissan	Armada	—	72-69493

CONTINUED ON NEXT PAGE



IN CHANNEL WIND DEFLECTORS CONTINUED HIGH GLOSS SMOKE HIGH-IMPACT ACRYLIC

START	END	MAKE	MODEL	2-PIECE	4-PIECE	START	END	MAKE	MODEL	2-PIECE	4-PIECE
2005	2021	Nissan	Frontier Crew Cab	—	72-69487	2003	2009	Toyota	4Runner	—	72-88489
2005	2021	Nissan	Frontier King Cab 3Dr	72-69488	—	2010	2021	Toyota	4Runner	—	72-88419
2003	2007	Nissan	Murano	—	72-69498	2002	2006	Toyota	Camry	—	72-88487
2003	2019	Nissan	Pathfinder	—	72-69479	2007	2011	Toyota	Camry	—	72-88411
2004	2016	Nissan	Titan	—	72-69491	2012	2014	Toyota	Camry	—	72-88423
2016	2021	Nissan	Titan/Titan XD Crew Cab	—	72-69483	2014 &	2017	Toyota	Camry	—	72-88431
2000	2004	Nissan	Xterra	—	72-69499	2014	2019	Toyota	Highlander	—	72-88429
2005	2016	Nissan	Xterra	—	72-69485	2001	2007	Toyota	Highlander Hybrid	—	72-88493
1996	2001	Oldsmobile	Brevada	72-29469	72-29489	2001	2006	Toyota	RAV4	—	72-88496
2019	2022	Ram	1500 Classic Crew Cab	—	72-35401	2006	2012	Toyota	RAV4	—	72-88409
2019	2022	Ram	1500 Classic Quad Cab	—	72-35403	2015	2016	Toyota	RAV4	—	72-88425
2009	2016	Ram	1500 Crew Cab	—	72-35401	2001	2007	Toyota	Sequoia	—	72-88497
2019	2022	Ram	1500 Crew Cab (Excl. Classic)	—	72-35407	2005	2016	Toyota	Tacoma Access Cab	72-88469	—
2002	2008	Ram	1500 Quad Cab	72-25469	72-25493	2001	2004	Toyota	Tacoma Double Cab	—	72-88499
2009	2016	Ram	1500 Quad Cab	—	72-35403	2005	2022	Toyota	Tacoma Double Cab	—	72-88433
2019	2022	Ram	1500 Quad Cab (Excl. Classic)	—	72-35409	2005	2015	Toyota	Tacoma Double Cab 4Dr	—	72-88407
1994	2001	Ram	1500 Reg Cab	72-25457	—	2007	2021	Toyota	Tundra CrewMax	—	72-88415
2010	2022	Ram	2500/3500 Crew Cab/Mega Cab	—	72-35401	2004	2006	Toyota	Tundra Double Cab	—	72-88401
2006	2009	Ram	2500/3500 Mega Cab	—	72-35499	2007	2021	Toyota	Tundra Double Cab	—	72-88413
2010	2022	Ram	2500/3500 Quad Cab	—	72-35403						
2002	2008	Ram	2500/3500 Reg Cab	72-25468	—						
2003	2009	Ram	2500/3500 Reg Cab	72-25468	—						
2005	2009	Saab	9-7X	—	72-39487						
2004	2007	Scion	xB	—	72-88403						
2003	2012	Scion	xB	—	72-88421						
2006	2012	Subaru	Tribeca	—	72-82479						
1996	2002	Toyota	4Runner	—	72-88491						

FOOTNOTES: 1. Compatible With Fixed Rear Window. 2. May Need To Reset Automatic Windows.

WIND GUARD WIND DEFLECTORS HIGH GLOSS SMOKE HIGH-IMPACT ACRYLIC

- » Flawless aerodynamic styling
- » Allows fresh air in any weather condition
- » Attaches using automotive grade tape
- » Made in the USA

FINISH: High Gloss Smoke
 MATERIAL: High-Impact Acrylic
 WARRANTY: Limited Lifetime



START	END	MAKE	MODEL	2-PIECE
1985	2004	Chevrolet	Astro Van	72-38464
1992	1999	Chevrolet	Blazer	72-38468
1988	1991	Chevrolet	Pickup	72-38463
1999	2007	Chevrolet	Silverado "Classic"	72-38472
2000	2005	Chevrolet	Suburban	72-38472
1992	1999	Chevrolet	Suburban	72-38468
2000	2005	Chevrolet	Tahoe	72-38472
1988	1999	GMC	Pickup	72-38468
1985	2005	GMC	Safari Van	72-38464
1999	2007	GMC	Sierra "Classic"	72-38472
1992	1999	GMC	Suburban	72-38468
2001	2006	GMC	Suburban	72-38472
1992	1999	GMC	Yukon	72-38468
2001	2006	GMC	Yukon	72-38472

WESTIN[™]

HOOD SCOOPS

HIGH-IMPACT ABS

BODY TRIM PRODUCTS



- » Gives the look of a performance hood
- » Easily paintable to match your vehicle
- » Manufactured from high impact ABS
- » Universal fit
- » Attaches using automotive grade tape

FINISH: Paintable

MATERIAL: High-impact ABS

WARRANTY: Limited Lifetime



RECOMMENDED USE

MAKE	MODEL	LARGE SINGLE	RACING ACCENT
Chevrolet	Pickup, C/K Series	—	72-13011
Chevrolet	Pickup, Sierra	72-14001	72-13011
Chevrolet	Pickup, Sierra Heavy Duty	72-14001	72-13011
Chevrolet	Pickup, Silverado	72-14001	72-13011
Chevrolet	Pickup, Silverado Heavy Duty	72-14001	72-13011
Chevrolet	Suburban	—	72-13011
Chevrolet	Tahoe	—	72-13011
Chevrolet	Yukon/Yukon XL	—	72-13011
Dodge	Pickup, Ram	72-14001	—
Ford	Pickup, F-150 SuperCrew	72-14001	—
Ford	Pickup, F-150 SuperCrew	72-14001	—
Ford	Pickup, F-250/350 Super Duty	72-14001	72-13011
Ford	Pickup, F-Series Full-Size	—	72-13011

UNIVERSAL APPLICATIONS

SIZE	SMOOTH
Large Single	72-14001

Wide Hood Scoops are UNIVERSAL. They will fit on any surface that is larger than the product dimensions. This list is supplied as a reference to recommended size only. If you do not see your vehicle on this list, choose one that is similar in size.

CAB GUARD WIND DEFLECTORS

HIGH GLOSS SMOKE HIGH-IMPACT ABS

- » Shades cab from sun
- » Reduces glare during night driving
- » Available in smoke and clear
- » Made in the USA

FINISH: High Gloss Smoke

MATERIAL: High-Impact Acrylic

WARRANTY: Limited Lifetime



START	END	MAKE	MODEL	SMOKE
1987	1990	Chevrolet	Pickup (W/ Light)	72-38106
1987	1990	Chevrolet	Pickup (W/O Light)	72-38104
1994	1996	Chevrolet	Pickup	72-38102
1994	2003	Chevrolet	S-10	72-38108
1994	2002	Dodge	Ram Pickup	72-34102
1987	1990	Ford	Pickup (W/ Light)	72-36106
1987	1990	Ford	Pickup (W/O Light)	72-36104
1994	1996	Ford	Pickup	72-36102
1993	1992	Ford	Ranger (W/ Light)	72-36112
1993	2003	Ford	Ranger (Excl. 4Dr)	72-36108
1994	1997	Nissan	Pickup	72-68102

MERCHANDISE DISPLAYS

DESCRIPTION	NOTE	PART NO.
Westin Truck Banner	Limit one (1) per location	55026
Westin Jeep Banner	Limit one (1) per location	55037
HDX Grille Guard & Running Board Display Stand	Product not included	55570

WESTIN TRUCK BANNER



WESTIN JEEP BANNER



PROFILE FLOOR LINERS
POINT OF PURCHASE DISPLAY
PN# 55475



SURE FIT FLOOR LINERS
POINT OF PURCHASE DISPLAY
COMING SOON



WESTIN IN CHANNEL
POINT OF PURCHASE DISPLAY
COMING SOON



WESTIN TAPE ON
POINT OF PURCHASE DISPLAY
COMING SOON



LED COUNTER TOP DISPLAY

COMPLETE DISPLAY WITH LIGHTS, GRAPHICS AND LITERATURE:
PN# 55409-02

- » Counter top overall size: 15" (L) x 17" (H) x 10.04" (D)
- » Includes four (4) LED lights:
 - B-Force Double Row
 - HyperQ
 - Axis LED Auxiliary Light (Round)
 - 5" Fusion5 EF LED Light Bar

- » Vivid graphic
- » Literature pocket on right side of display
- » Includes 2 packs of 25 folded product brochures
- » Individual On/Off switches
- » Plug-in power source
- » No assembly required



WESTIN

RETAIL SUPPORT

STEP-UP TOWER DISPLAY* (ONLY)

PN# 55470

- » Highly Visible 12" x 36" Color Header
- » Locking Casters
- » Product sold separately

NERF STEP BAR AND RUNNING BOARD SAMPLES

- » 40" product samples
- » Finished ends for accurate representation
- » Hardware included
- » 26 step samples options available

STEP-UP TOWER W/ 6 STEP SAMPLES

PN# 55476

- » Includes Tower w/ 6 Step Samples
- R5 Nerf Step Bar / Textured Black
- R7 Nerf Step Bar / Black
- Grate Steps / Textured Black
- Pro Traxx® 5 Sample / Polished
- HDX Drop Step / Textured Black
- Outlaw Drop Step Sample / Textured Black

DESCRIPTION	FINISH	PART NO.
Grate Steps Running Board - 40" Sample	Textured Black	27-75475
PRO TRAXX 4 - 40" Sample	Polished	21-52400
PRO TRAXX 4 - 40" Sample	Black	21-52405
Platinum 4 - 40" Sample	Polished	21-5470
PRO TRAXX 5 - 40" Sample	Polished	21-55400
PRO TRAXX 5 - 40" Sample	Black	21-55405
PRO TRAXX 6 - 40" Sample	Polished	21-65400
PRO TRAXX 6 - 40" Sample	Black	21-65405
E-Series 3 - 40" Sample	Polished	23-5470
Signature 3 - 40" Sample	Black	25-5475
Molded Lighted/Un-Lighted Running Board - 40" Sample	Black	27-0410
Sure-Grip Running Board - 40" Sample	Brn	27-6420
SG6 Lighted Running Board - 40" Sample	Polished	27-5790
SG6 Lighted Running Board - 40" Sample	Black	27-5795
R5 Nerf Step - 40" Sample	Polished	28-55400
R5 Nerf Step - 40" Sample	Black	28-55405
Stylized Running Board - 40" Sample	Black/Polished	28-55420
R7 Nerf Step 40" Sample	Polished	28-75400
R7 Nerf Step 40" Sample	Black	28-75405
Outlaw Drop Step - 40" Sample	Textured Black	20-55405
Thrasher Step Board - 50" Sample	Textured Black	28-85405
Triple Tube Rock Rail - 40" Sample	Textured Black	42-8545
HDX Drop Step - 40" Sample	Textured Black	58-15405
HDX Stainless Drop Step - 40" Sample	Textured Black	58-154052
HDX Xtreme Step Board - 40" Sample	Textured Black	58-25405



MIX & MATCH

R5 NERF STEP - 40"
PART NO. 28-55405

R7 NERF STEP - 40"
PART NO. 28-75405

GRATE STEPS - 40"
PART NO. 27-75475

PRO TRAXX 5 - 40"
PART NO. 21-55400

HDX DROP STEP - 40"
PART NO. 58-15405

OUTLAW DROP STEP - 40"
PART NO. 20-55405

LITERATURE



Application Guide
PN# W18

Product Guide
PN# W02

SUPERWINCH DISPLAY

PN# 55660
Winches not included



NERF STEP BARS/RUNNING BOARDS TOUCH UP PAINT



4.5 OZ. AEROSOL CAN

BLACK PN# 88-0005

TEXBLACK PN# 88-0025

.6 OZ. BRUSH CAP BOTTLE

BLACK PN# 88-0015

TEXBLACK PN# 88-0035

1 YEAR WARRANTY

- **COMPONENTS, ELECTRICAL PARTS/WIRING** (• Halogen Driving Lights, Lighted Molded Running Board, Off-Road Halogen Lights, Sure-Grip Light Kit, LED Wiring Harness, Westin Winches.)

Westin Automotive Products, Inc. guarantees the original purchaser of Westin products a (1) one year warranty from the date of original purchase against manufacturer defects in materials, workmanship and finish under normal use excluding damage resulting from road hazards such as gravel or other debris, product misuse, improper installation, impairments from accidents, product modifications or product neglect. This one year warranty applies only to new products and is limited to the repair or replacement of Westin products. Warranty does not include electrical components or light bulb replacement, costs of removal, installation, labor, freight, inconvenience or consequential damages. Original purchaser must return defective merchandise, along with the purchase receipt, to the original place of purchase. This warranty does not cover damage resulting from accident, misuse, neglect, improper installation, fire, vandalism or any form of abuse.

- **TEXTURED BLACK FINISH** (HDX Bumpers, Marksman Bumpers, Scope Bumpers, Recoil Bumpers, Skid Plates.)

Westin Automotive Products, Inc. guarantees the original purchaser of Westin products a (1) One year warranty on the product finish from the date of original purchase under normal use excluding damage resulting from road hazards such as gravel or other debris, product misuse, improper installation, impairments from accidents, product modifications or product neglect. This (1) One year warranty applies only to new products and is limited to the repair or replacement of Westin products. Warranty does not include electrical components or light bulb replacement, costs of removal, installation, labor, freight, inconvenience or consequential damages. Original purchaser must return defective merchandise, along with the purchase receipt, to the original place of purchase. This warranty does not cover damage resulting from accident, misuse, neglect, improper installation, fire, vandalism or any form of abuse.

3 YEAR WARRANTY

- **BLACK POWDER COAT, TEXTURED BLACK, WRINKLE BLACK FINISH** (Overland Cargo Rack, Ball Mounts, Bed Mats and Tailgate Mats, E-Series Step Bars, Pro-Mod Front Bumper, Pro-Mod Rear Bumper, Pro-Series Front Bumper, Pro-Series Rear Bumper, Outlaw Front Bumper, Outlaw Rear Bumper, Outlaw Bumper Hitch Accessory, HDX Bandit Front Bumper, HDX Bandit Rear Bumper, Sportsman X Grille Guard, Sportsman Grille Guard, Sportsman Winch Mount Grille Guard, Contour LED Bull Bar, Ultimate LED Bull Bar, Contour 3.5 Bull Bar, Contour LED DRL Bull Bar, Contour Safari Light Bar, E-Series Bull Bar, FEY Bumpers, GenX Oval Steps, HD Bar Clamp Brackets, HDX Bumpers, HDX Grille Guard, HDX Winch Mount Grille Guard, HDX Drop Nerf Step Bars, HDX Stainless Drop Nerf Step Bars, HDX Xtreme Boards, Outlaw Nerf Step Bars, R5 Nerf Step Bars, R7 Nerf Step Bars, Thrasher Running Boards, HDX Light Clamps, HDX LED Grille (excl. Light Bar), B-Force Roof Mount 50" LED Light Bar Kit, HD Overhead Truck Rack, HD Headache Rack, HD Ladder Rack,

LED Light Mounts, License Plate Re-Locator, MAX Bull Bar/Light Bar, MAX Tow Hooks, WJ2 Stubby Bumper, WJ2 Stubby Bumper with Bull Bar, WJ2 Stubby Bumper with LED Light Bar Mount, WJ2 Full Width Front Bumper, WJ2 Full Width Front Bumper with Bull Bar, WJ2 Full Width Front Bumper with LED Light Bar Mount, WJ2 Rear Bumper, WJ2 Rear Bumper with Tire Carrier, WJ2 Front Bumper Skid Plates, WJ2 Bumper Accessories, WJ2 Inner Fenders, LED Hood Scoops, Jeep Front and Rear Tube Fenders, Triple Tube Rock Rail Steps, Rock Slider Steps, MAX Winch Tray, Non-Electrical Winch Accessories, Off-Road Light Bar, Oval 4" Tube Steps, Platinum 4" Oval Step Bars, Platinum 4" Oval Wheel-to-Wheel Step Bars, Premier 6" Oval Tube Steps, PRO TRAXX 4/5/6 Oval Step Bars, PRO TRAXX 5 W2W, Outlaw Nerf Step Bars, Grate Steps Running Boards, Receiver Hitches, Sensor Re-locator, Trailblazer Bumpers and Rocker Bars, HDX Drop Hitch Step, R5 Hitch Step, PRO TRAXX 5 Hitch Step, Grate Steps Hitch Step.)

- **BRUSHED ALUMINUM FINISH** (Truck-Pal)
- **WHITE FINISH** (Headache Rack, Ladder Rack)
- **POLISHED** (Westin Towing Accessories, Parking Sensor Re-Locator)
- **MECHANICAL COMPONENTS, NON ELECTRICAL ACCESSORIES** (Westin Winches, Winch Accessories)
- **CHROME, SILVER** (FEY Bumpers, HD Running Board, Signature Series Step Bars.)

Westin Automotive Products, Inc. guarantees the original purchaser of Westin products a three year warranty from the date of original purchase against manufacturer defects in materials, workmanship and finish under normal use excluding damage resulting from road hazards such as gravel or other debris, product misuse, improper installation, impairments from accidents, product modifications or product neglect. This three year warranty applies only to new products and is limited to the repair or replacement of Westin products. Warranty does not include electrical components or light bulb replacement, costs of removal, installation, labor, freight, inconvenience or consequential damages. Original purchaser must return defective merchandise, along with the purchase receipt, to the original place of purchase. This warranty does not cover damage resulting from accident, misuse, neglect, improper installation, fire, vandalism or any form of abuse.

5 YEAR WARRANTY

- **BLACK POWDER COAT FINISH, TEXTURED BLACK, (HDX Stainless Drop Nerf Step Bars, HDX Stainless W2W Nerf Step Bars, HDX Stainless Hitch Step, R5 M-Series W2W Nerf Step Bars, HDX LED Grille, HLR Truck Rack, Lighted and Unlighted Molded Running Boards, Safari Light Bar, Signature Series Step Bars, Ultimate Bull Bar, Stylized Running Boards.)**
- **POLISHED, BRUSHED, POLISHED, BLACK ALUMINUM** (SG6 LED Running Boards, SG6 Running Boards, Sure-Grip Running Boards)

Westin Automotive Products, Inc. guarantees the original purchaser of Westin products a (5) five year warranty from the date of original purchase against manufacturer defects in materials, workmanship and finish under normal use excluding damage resulting from road hazards such as gravel or other debris, product misuse, improper installation, impairments

from accidents, product modifications or product neglect. This (5) five year warranty applies only to new products and is limited to the repair or replacement of Westin products. Warranty does not include electrical components or light bulb replacement, costs of removal, installation, labor, freight, inconvenience or consequential damages. Original purchaser must return defective merchandise, along with the purchase receipt, to the original place of purchase. This warranty does not cover damage resulting from accident, misuse, neglect, improper installation, fire, vandalism or any form of abuse.

LIFETIME WARRANTY

- CHROME OR POLISHED FINISH (Bed Rails, Contour LED Bull Bar, Contour 3.5" Bull Bar, Contour Safari Light Bar, E-Series Bull Bar, E-Series Step Bars, GenX Oval Steps, HDX Grille Guard, HDX Winch Mount Grille Guard (Excludes Winch Tray), HDX Light Clamp, R5 Boards, R7 Boards, MAX Bull Bar/Light Bar, Off-Road Light Bar, Oval 4" Tube Steps, Platinum 4" Oval Step Bars, Platinum 4" Oval Wheel-to-Wheel Oval Step Bars, Platinum Series 3" Step Bars (Chrome Stainless), Premier 6" Oval Tube Steps, PRO TRAXX 4/5/6 Oval Step Bars, PRO TRAXX 5 W2W, Safari Light Bar, Sportsman Grille Guard, Sportsman Winch Mount Grille Guard (Excludes Winch Tray), Sensor Re-locator, Ultimate Bull Bar, Winch Tray Faceplates, Stylized Running Board.)

Westin Automotive Products, Inc. guarantees the original purchaser a lifetime warranty against manufacturer defects in materials, workmanship and finish under normal use excluding damage resulting from road hazards such as gravel or other debris, product misuse, improper installation, impairments from accidents, product modifications or product neglect. This lifetime warranty applies only to new products and is limited to the repair or replacement of Westin products. Warranty does not include costs of removal, installation, labor, freight, inconvenience or consequential damages. Original purchaser must return defective merchandise, along with the purchase receipt, to the original place of purchase. This warranty does not cover damage resulting from accident, misuse, neglect, improper installation, fire, vandalism or any form of abuse.

LIMITED LIFETIME WARRANTY

- ACRYLICS, FLOOR MATS & LINERS, AND TOWING ELECTRICAL PRODUCTS (Bed Caps, Cab Guard, Front Caps, Headlight Covers, Hood Scoops, Platinum Bug Shields, Sun Roof Guard, Sure-Fit Cargo Mats, Sure-Fit Floor Mats, Tail Light Covers, Tailgate Covers, Ultraguard Bug Shields, Wind Deflectors In-Channel, Wind Deflectors Tape-On (Slim), Wind Guards, Skytop, Profile Floor Liners, and Westin Towing Electrical (Adapters, Connectors, Mounting Brackets, T-Connectors, Tail Light Converters.)
- TOW ACCESSORIES (Tow Accessories (Couplers, Nut & Washers, Pins & Clips, Quick Links, Receiver Tube Adapters, Receiver Tube Extenders, Safety Chains, Trailer Balls).
- WESTIN OFFROAD PRODUCTS (HDX Bumpers, Snypner Bumpers)

Westin Automotive Products warrants these products to be free of original defects in materials or workmanship as long as the original purchaser owns the vehicle on which it is installed. This warranty does not cover damage resulting from accident, misuse, neglect, improper installation, fire, vandalism or any form of abuse. Westin will repair or replace, at its sole discretion, any product covered by this warranty. This is a parts-only warranty and such repair or replacement shall be Westin's only obligation, and the customer's only remedy for a defective product. The cost of labor, installation, painting, incidental damages, shipping and handling will not be reimbursed. We do not warrant the paint or painting of our products. If, at our discretion, we choose to replace a defective part the customer (end consumer) may be responsible for any occurring freight cost, or a handling fee of up to \$25.00. Westin Automotive Products, Inc. guarantees the original purchaser of Westin Towing Electrical products for manufacturing defects with regards to wiring, connectors, mounting brackets and tow accessories for (1) One year from the date of original purchase. Westin shall have no liability for any incidental or consequential damages of any kind including property damage, or personal injury resulting from the use or misuse of this product.

- POLISHED ALUMINUM AND BLACK POWDER COATED FINISH (All Brute Tool Boxes (All Brute Tool Boxes (Bedsafe, Chest Boxes, Conduit Carriers, Contractor Boxes, CrossOver Boxes, Goose Neck/Fifth Wheel Tool Boxes, Gull Wing Boxes, HD Step Boxes, HD TopSider Boxes, HD TopSider Boxes, HD Under Body Boxes, HD Underbody Boxes, High Capacity Stake Bed Boxes, Job Site Box, Lo Sider Boxes, LoSider Side Rail Boxes, Maximum Chest Boxes, Pork Chop Boxes, Under Body Boxes.)

Westin Automotive Products warrants Brute Tool Boxes to be free of original defects in material and workmanship to the original purchaser of the product, with proof of purchase, and is limited to the original vehicle installation. Westin warrants Brute Tool Boxes with a polished aluminum or black powder coat finish for 12-months from date of original purchase. This warranty does not cover damage resulting from wear and tear of daily use, accident, misuse, neglect, improper installation, fire, vandalism or any form of abuse. This warranty is void if product is altered in any way. Westin will repair or replace, at its

sole discretion, product covered by this warranty. If, at our discretion a product requires repair or return, the customer (end consumer) will be responsible for the cost of shipping to and from the manufacturer as needed. Standard shipping for claims is ground to and from manufacturer. Any expedited shipping fees will be incurred at the discretion of the consumer. Please contact Westin's customer service department for Brute Tool Box warranty claims directly at: 800-345-8476 M-F 7am - 4pm PST. Excludes holidays.

- BLACK (LED Light Bars, LED Auxiliary Lights, LED Work Utility Lights, LED Rock Light Kit.)
- LED LIGHTS (B-FORCE, EF2, FM4Q, FM6, Performance2X, Xtreme, Razor, Fusion5, EF, Ultra, Striker, Axis, Odyssey, Ranger, Quadrant, Hyper Q, Hyper Q B-FORCE, HD Round, HD Square, Round LED, Square LED, Swivel LED.)

Westin Automotive Products warrants LED Light Bars, LED Auxiliary Lights, LED Work Utility Lights to be free of original defects in material and workmanship to the original purchaser of the product, with proof of purchase, and is limited to the original vehicle installation. Westin will repair or replace, at its sole discretion, product covered by this warranty. If, at our discretion a product requires repair or return, the customer (end consumer) will be responsible for the cost of shipping to and from the manufacturer as needed. Standard shipping for claims is ground to and from manufacturer. Any expedited shipping fees will be incurred at the discretion of the consumer. Please contact Westin's customer service department for LED Light warranty claims directly at: 800-345-8476 M-F 7am - 4pm PST. Excludes holidays. This warranty does not cover damage resulting from accident, misuse, neglect, improper installation, fire, vandalism or any form of abuse. This warranty is void if the LED housing is opened or unscrewed, if the protective seal is broken, or if tampering is evident. Westin Automotive reserves the right to make the aforementioned determinations to grant or deny warranty. Westin shall have no liability for any incidental or consequential damages of any kind including property damage, or personal injury resulting from the use or misuse of this product. Excludes LED Brackets.

FINISH PROTECTION

Westin products have a high quality finish that must be cared for like any other exposed finish on the vehicle. Protect the finish with a non-abrasive automotive wax, (e.g. Pure Carnauba) on a regular basis. The use of any soap, polish or wax that contains an abrasive is detrimental, as the compounds scratch the finish and open it to corrosion.

DISCLAIMER FOR WESTIN PRODUCTS

Buyer assumes all risk and liability whatsoever from the installation and use of Westin products. Westin products are sold as appearance accessories and should not be relied upon as protection for the vehicle or occupants in the event of a collision or roll over. Vehicles equipped with a supplemental restraint system (air bags) deployed by impact should not be modified by any aftermarket Grille Guard, Push Bar, Light Bar or Bull Bar without first consulting the vehicle manufacturer. Westin Automotive Products, Inc. assumes no liability for injury, loss, incidental or consequential damages in the event of an accident. All warranties are subject to change without notice. Westin Public Safety Elite products are designed for exterior vehicle protection. Westin Public Safety Elite products are designed for exterior vehicle protection.

DISCLAIMER FOR WINCHES

Westin warrants each Winch against factory defects in material and workmanship to the original purchaser for the period of one year. The owner will be responsible for removing the winch and returning it with freight prepaid. Westin will repair or replace at its discretion the defective product or part. The purchaser must send a copy of the original receipt to qualify for any warranty consideration. Exclusions from this warranty are the finish and conditions determined to have been caused by abuse or abnormal use. This warranty shall not apply to any electric winch improperly operated or improperly installed. There are no warranties, expressed or implied, which extend beyond the original purchaser. The loss of use from any vehicle, loss of time, inconvenience, commercial loss or consequential damages is not covered. Westin reserves the right to redesign and make any changes to any product without assuming any obligation to modify any product previously supplied or manufactured. Any commercial or industrial use or application, or any hoisting application of the winch will void the warranty. All warranties are subject to change without notice.

DISCLAIMER FOR WESTIN/WADE PRODUCTS

The foregoing warranties are exclusive and in lieu of ALL OTHER WESTIN WARRANTIES, expressed or implied, and Westin Automotive Products disclaims all other warranties. Westin reserves the right to change product design and material without prior notice to customers.

CONTINUED ON NEXT PAGE ➡

WARRANTY COVERAGE:

Superwinch warrants to the original user of its products that the products will, at the date of initial purchase, meet the applicable specification for such products and will be free from any defects in materials or manufacture under use for the standard warranty period stated in the products warranty. (see next page for more info).

DISCLAIMER OF WARRANTY OF PRODUCT SUITABILITY:

Superwinch makes no warranty to the purchaser of any third party that its products are suitable for a particular application or design. Many states and localities have differing codes or regulations governing the installation and/or use of superwinch products. Superwinch cannot guarantee compliance with such regulations; purchaser is solely responsible for safe and correct installation and use of the product and for compliance with applicable codes and regulations.

EXCLUSION OF IMPLIED WARRANTIES

This warranty is the only warranty applicable to this product and excludes all other warranties, including any warranty of merchantability, any warranty of fitness for a particular purpose, and any implied warranties otherwise arising from cause of dealing or usage of trade.

LIMITED WARRANTY PROCEDURE:

When contacting seller, buyer shall mail, ship or otherwise deliver to seller at the address noted below or to a factory authorized service center: (1) The product; (2) A written description of the problem; (3) Buyer's name, address and telephone number; and (4) A copy of the original sales receipt. Mail, ship or otherwise deliver the product, required information and copies to seller, postage or shipping prepaid.

LIMITATION OF LIABILITY:

Repair and/or replacement of the product is the sole and exclusive remedy for buyer. This warranty does not apply to defects in any product caused by:

- A. Normal wear and tear
- B. Failure to comply with any installation, operation or maintenance instructions provided by superwinch including but not limited to subjecting the product to loads in excess of the load listed in the owner's manual or instructions for the particular product and mode number;
- C. Commercial or industrial use of consumer product;
- D. Alteration or modification by parties other than Superwinch; (5) misuse, abuse, neglect, accident, acts of god or terrorism; or
- E. Other causes beyond the control of superwinch after delivery of the product by superwinch to its authorized distributor. If any model or sample was shown to buyer, such model or sample was used for illustrative purposes only and shall not be construed as a warranty that the product shall conform to the sample or model. Superwinch will not be liable for any incidental, special, indirect or consequential damages resulting from any defect in the product.

EXCLUSIONS

To the fullest extent permitted by applicable law, the following are hereby excluded and disclaimed:

- A. All warranties with respect to the wire and synthetic rope, whether sold alone, with or used in or incorporated in any product.
- B. All warranties with respect to the product's finish
- C. All warranties of fitness for a particular purpose.
- D. All warranties of merchantability.
- E. All claims for consequential or incidental damages, including damage caused by or during the removal or reinstallation of the product.

INQUIRIES

Any inquiries regarding compliance with warranties provided herein may be addressed in writing to superwinch, at address noted below.

SUPERWINCH
320 W. COVINA BLVD.
SAN DIMAS, CA 91773
ATTN: CUSTOMER SERVICE
INFO@SUPERWINCH.COM

CURRENT WARRANTY TERMS BY PRODUCT LINES ARE OUTLINED BELOW:

PART #	PRODUCT DESCRIPTION	WARRANTY
1585202	LP8500	Limited 1 Year
1510200	LP10000	Limited 1 Year
1120210	LT2000	Limited 1 Year
1130220	LT3000	Limited 1 Year
1140220	LT4000	Limited 1 Year
1140230	LT4000	Limited 1 Year
1331200	UT3000	Limited 1 Year
1455200	S5500	Limited 2 Year
1455201	S5500	Limited 2 Year
1475200	S7500	Limited 2 Year
1475201	S7500	Limited 2 Year
S104103	SH1000i Hoist	Limited 2 Year
S104089	SH1000 Hoist	Limited 2 Year
1715001	AC 1500 Winch	Limited 2 Year
1125260	TERRA 2500	Limited Lifetime Mechanical / 3 Year Limited Electrical
1125270	TERRA 2500SR	Limited Lifetime Mechanical / 3 Year Limited Electrical
1135260	TERRA 3500	Limited Lifetime Mechanical / 3 Year Limited Electrical
1135270	TERRA 3500SR	Limited Lifetime Mechanical / 3 Year Limited Electrical
1145260	TERRA 4500	Limited Lifetime Mechanical / 3 Year Limited Electrical
1145270	TERRA 4500SR	Limited Lifetime Mechanical / 3 Year Limited Electrical
1710200	SX 10000	Limited Lifetime Mechanical / 7 year Limited Electrical
1710201	SX 10000SR	Limited Lifetime Mechanical / 7 year Limited Electrical
1712200	SX 12000	Limited Lifetime Mechanical / 7 year Limited Electrical
1712201	SX 12000SR	Limited Lifetime Mechanical / 7 year Limited Electrical
1595200	TIGER SHARK 9500	Limited Lifetime Mechanical / 7 year Limited Electrical
1595201	TIGER SHARK 9500	Limited Lifetime Mechanical / 7 year Limited Electrical
1511200	TIGER SHARK 11500	Limited Lifetime Mechanical / 7 year Limited Electrical
1511201	TIGER SHARK 11500	Limited Lifetime Mechanical / 7 year Limited Electrical
1513200	TIGER SHARK 13500	Limited Lifetime Mechanical / 7 year Limited Electrical
1515200	TIGER SHARK 15500	Limited Lifetime Mechanical / 7 year Limited Electrical
1517200	TIGER SHARK 17500	Limited Lifetime Mechanical / 7 year Limited Electrical
1515000	TIGER SHARK 15000	Limited Lifetime Mechanical / 7 year Limited Electrical
1515001	TIGER SHARK 15000SR	Limited Lifetime Mechanical / 7 year Limited Electrical
1518000	TIGER SHARK 18000	Limited Lifetime Mechanical / 7 year Limited Electrical
1518001	TIGER SHARK 18000SR	Limited Lifetime Mechanical / 7 year Limited Electrical
1518200	TIGER SHARK 18000 24V	Limited Lifetime Mechanical / 7 year Limited Electrical
1518201	TIGER SHARK 18000SR 24V	Limited Lifetime Mechanical / 7 year Limited Electrical
1518100	TIGER SHARK 66.7 KN EN 24V	Limited Lifetime Mechanical / 7 year Limited Electrical
1695200	TALON 9.5	Limited Lifetime Mechanical / 7 year Limited Electrical
1695210	TALON 9.5I	Limited Lifetime Mechanical / 7 year Limited Electrical
1695211	TALON 9.5ISR	Limited Lifetime Mechanical / 7 year Limited Electrical
1695201	TALON 9.5SR	Limited Lifetime Mechanical / 7 year Limited Electrical
1612200	TALON 12.5	Limited Lifetime Mechanical / 7 year Limited Electrical
1612201	TALON 12.5SR	Limited Lifetime Mechanical / 7 year Limited Electrical
1618200	TALON 18	Limited Lifetime Mechanical / 7 year Limited Electrical
1618201	TALON 18SR	Limited Lifetime Mechanical / 7 year Limited Electrical
1140222	WINCH2GO	Limited 2 Year
1140232	WINCH2GO	Limited 2 Year

This policy applies to Superwinch designed and manufactured products only.

WESTIN®

ENGINEERED FOR ENTHUSIASTS

S

SUPERWINCH

WESTIN CUSTOMER SERVICE 7AM – 4PM PST

PH: 800. 345. 8476

FAX: 626. 813. 4890

EMAIL: CUSTOMERSERVICE@WESTINAUTOMOTIVE.COM

SUPERWINCH CUSTOMER SERVICE

PH: 800. 323.2031

EMAIL: INFO@SUPERWINCH.COM

CORPORATE HEADQUARTERS

PH: 626. 960. 6762

320 WEST COVINA BLVD. SAN DIMAS, CA 91773

DISTRIBUTION CENTERS

ST. JAMES – 240 S. FIFTEENTH STREET, ST. JAMES, MN. 56081

DALLAS/FT. WORTH – 4675 RAILHEAD RD, SUITE 101, FORT WORTH, TX 76106



DISTRIBUTED BY:

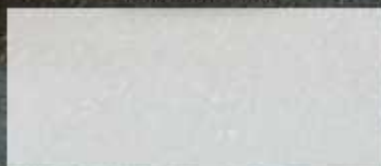

**SEARCH #WESTINAUTOMOTIVE
#SUPERWINCH AND STAY CONNECTED!**



WESTINAUTO.COM / SUPERWINCH.COM

©2023 WESTIN AUTOMOTIVE PRODUCTS, INC. / PRINTED IN USA

WS21 / 090723

For California Residents Only: Westin Superwinch is a registered trademark of Westin Automotive Products, Inc. All other trademarks are the property of their respective owners. ©2023 Westin Automotive Products, Inc.

